

U.S. DEPARTMENT OF COMMERCE  
NATIONAL OCEANIC AND ATMOSPHERIC ADMINISTRATION  
NATIONAL OCEAN SERVICE

## Data Acquisition & Processing Report

*Type of Survey* Hydrographic  
*Project No.* 2009 Field Season  
*Registry No.* \_\_\_\_\_

### LOCALITY

*State* Alaska  
*General Locality* \_\_\_\_\_

CAPT Douglas D. Baird  
CHIEF OF PARTY

### LIBRARY & ARCHIVES

DATE \_\_\_\_\_



*Fairweather 2009*  
Data Acquisition & Processing Report



**INTRODUCTION ..... A-1**

**A EQUIPMENT..... A-1**

1.0 Hardware ..... A-1

**1.1 Hardware Systems Inventory ..... A-1**

**1.2 Echo Sounding Equipment ..... A-1**

        1.2.1 RESON 8111ER Multibeam Echosounder (MBES) ..... A-1

        1.2.2 RESON 8160 Multibeam Echosounder (MBES) ..... A-1

        1.2.3 RESON 8101ER Multibeam Echosounder (MBES) ..... A-2

        1.2.4 RESON 8125 Multibeam Echosounder (MBES) ..... A-3

        1.2.5 Odom Echotrac CVM (VBES)..... A-3

        1.2.6 Klein Series 5000 Side Scan Sonar ..... A-4

**1.3 Manual Sounding Equipment ..... A-5**

        1.3.1 Diver’s Least Depth Gauge ..... A-5

        1.3.2 Lead Lines..... A-6

**1.4 Positioning, Heading, and Attitude Equipment ..... A-6**

        1.4.1 TSS Positioning and Orientation System for Marine Vehicles (POS/MV) ..... A-6

        1.4.2 POS/MV GAMS Calibration ..... A-6

        1.4.3 CSI Wireless MBX-3S DGPS Receiver..... A-7

        1.4.4 Trimble Backpack ..... A-7

        1.4.5 Impulse LR Hand-held Laser ..... A-8

**1.5 Sound Velocity Equipment ..... A-8**

        1.5.1 SBE 19plus SEACAT Profiler ..... A-8

        1.5.2 Moving Vessel Profiler 200 ..... A-9

        1.5.3 RESON Sound Velocity Probe (SVP 70)..... A-10

        1.5.4 Odom Digibar Pro..... A-11

**1.6 Vertical Control Equipment ..... A-11**

        1.6.1 Water Level Gauges ..... A-11

        1.6.2 Leveling Equipment ..... A-11

**1.7 Horizontal Control Equipment ..... A-12**

2.0 Software..... A-12

**2.1 Software Systems Inventory ..... A-12**

**2.2 Data Acquisition Software ..... A-12**

        2.2.1 HYPACK® HYSWEEP ..... A-12

        2.2.2 CARIS Notebook ..... A-13

**2.3 Data Processing Software ..... A-13**

        2.3.1 NOAA Hydrographic Systems and Technology Programs (HSTP) Software..... A-13

        2.3.2 CARIS..... A-13

        2.3.3 Fledermaus™..... A-14

        2.3.4 Geocoder..... A-14

3.0 Vessels ..... A-14

**3.1 Vessel Inventory ..... A-14**

**3.2 Noise Analysis ..... A-14**

4.0 Data Acquisition ..... A-14

**4.1 Horizontal Control ..... A-14**

**4.2 Multibeam Echosounder Acquisition and Monitoring Procedures ..... A-15**

**4.3 Shoreline Verification ..... A-15**

5.0 Bottom Sample Acquisition..... A-16

**B QUALITY CONTROL ..... B-16**

1.0 Uncertainty Modeling ..... B-16

2.0 Data Processing ..... B-16

**2.1 Multibeam Echosounder Data Processing..... B-16**

**2.2 Shoreline Data Processing..... B-18**

Process Owner: Survey Updated: 9/1/2009	Approval: CO <i>Fairweather</i> Approval Date: 2009	
--	--	--

3.0	Data Review.....	B-19
<b>C</b>	<b>CORRECTIONS TO ECHO SOUNDINGS .....</b>	<b>C-19</b>
1.0	Vessel HVFs .....	C-19
2.0	Vessel Offsets .....	C-19
3.0	Static and Dynamic Draft .....	C-20
4.0	Patch Tests .....	C-21
5.0	Attitude .....	C-21
5.1	<b>True Heave</b> .....	C-21
6.0	Sound Velocity .....	C-21
7.0	Water Level .....	C-22

**APPENDICES**

- Appendix I System Tracking
- Appendix II Equipment Specs
- Appendix III Vessel Reports, Offsets, and Diagrams
- Appendix IV TPE
- Appendix V Additional Calibration Reports
- Appendix VI Correspondence



## *Fairweather* 2009 Data Acquisition & Processing Report



### INTRODUCTION

This Data Acquisition and Processing Report outlines the acquisition and processing procedures used for Hydrographic projects surveyed in 2009 by the NOAA Ship *Fairweather*.

Survey specific details will be listed in Descriptive Reports as needed. Unless otherwise noted, the acquisition and processing procedures used and deliverables produced are in accordance with the NOAA *Hydrographic Survey Specifications and Deliverables Manual (HSSD) April 2009*, the *Field Procedures Manual (FPM), May 2009*, and all active Hydrographic Surveys Technical Directives (HTD).

Any additions and changes to the following will be included with the individual Descriptive Reports.

### A EQUIPMENT

Detailed descriptions of the equipment and systems, including hardware and software, used for bathymetric data acquisition, horizontal and vertical control operations, shoreline acquisition, and processing are listed below.

#### 1.0 Hardware

The hardware listed in this section was used throughout the 2009 field season.

##### 1.1 Hardware Systems Inventory

Detailed hardware information, including installation dates and serial numbers, is included in Appendix I of this report. Manufacturer's product specifications are included in Appendix II.

##### 1.2 Echo Sounding Equipment

###### 1.2.1 RESON 8111ER Multibeam Echosounder (MBES)

*Fairweather* is equipped with a RESON SeaBat 8111 MBES with the Extended Range (ER) and snippet options. The 8111ER is a 100 kHz multibeam system with swath coverage of 150°. The swath is made up of 101 discrete beams with an along-track and across-track beamwidth of 1.5°. It has a specified depth range of 3 to 1200 meters, though the typical operational depth range of the 8111ER on the *Fairweather* is 20 to 300 meters. No calibration information was provided by the manufacturer for the system.

The 8111ER is hull-mounted within a reinforced projection that extends 27 inches below the keel. It is located 39.5" starboard of the centerline at approximately frame 29 (see Figures 1 & 2).

###### 1.2.2 RESON 8160 Multibeam Echosounder (MBES)

*Fairweather* is equipped with a RESON SeaBat 8160 MBES with the snippet option. The 8160 is a 50 kHz multibeam system with a swath coverage of greater than 4x water depth. Each swath is made up of 126 discrete beams with an along-track and across-track beamwidth of 1.5°. It has a specified depth range of 10 to 3000 meters, though the typical operational depth range of the RESON 8160 on *Fairweather* is 300 to 1000 meters. No calibration information was provided by the manufacturer of the system.

The 8160 is hull-mounted within a reinforced projection that extends 13.6 inches below the keel. It is located 54 inches port of the centerline at approximately frame 29 (see Figures 3 & 4).

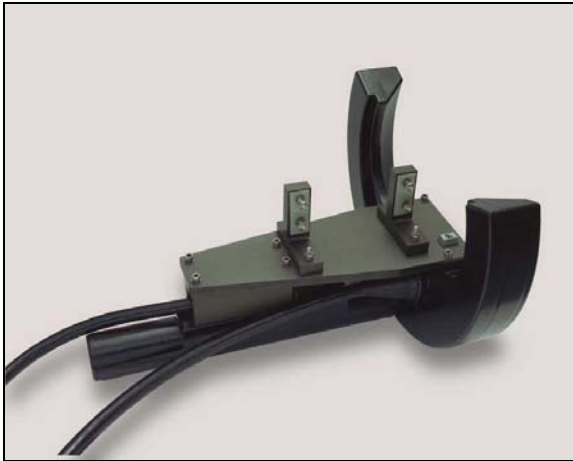


Figure 1: RESON SeaBat 8111ER MBES



Figure 2: RESON SeaBat 8111ER MBES on *Fairweather*



Figure 3: RESON SeaBat 8160



Figure 4: RESON SeaBat 8160 on *Fairweather*

### 1.2.3 RESON 8101ER Multibeam Echosounder (MBES)

Survey Launches 1010 and 1018 are each equipped with a RESON SeaBat 8101 MBES with the Extended Range and snippet option. The 8101ER is a 240 kHz multibeam system with a swath coverage of 150°. The swath is made up of 101 discrete beams with an along-track and across-track beamwidth of 1.5°. It has a specified depth range of up to 500 meters. The typical operational depth range of the RESON 8101 on launches 1010 and 1018 is 3 to 100 meters. Under optimal conditions with a hard bottom, high power and high gain, the depth range of the 8101 ER was observed to be as deep as 350 m producing a swath of  $\pm 45^\circ$  from nadir. No calibration information was provided by the manufacturer for the system.

Each system is attached to a launch using a swing mount which is starboard of the keel and approximately centered fore and aft (see Figures 5 & 6).



**Figure 5: Launch 1010 with 8101 extended**



**Figure 6: Launch 1010 with 8101 retracted**

#### 1.2.4 RESON 8125 Multibeam Echosounder (MBES)

Survey Launch 1018 can be equipped with a RESON SeaBat 8125 MBES with snippet option. The 8125 is a 455 kHz multibeam system with swath coverage of 120°. The swath is made up of 240 discrete beams with an along-track beamwidth of 1° and an across-track beam spacing of 0.5°. It has a maximum range scale of 120 meters for surveying depths less than 60 meters with a complete swath. The typical operational depth range of the 8125 on launch 1018 is 3 to 50 meters. No calibration information was provided by the manufacturer for the system.

The system is attached to the launch using a bolted-on sled mount which is on the port side of the keel and approximately centered fore and aft (see Figure 7).



**Figure 7: Launch 1018 with 8125**

#### 1.2.5 Odom Echotrac CVM (VBES)

The Odom Echotrac CVM Vertical Beam Echo Sounder (VBES) is portable (Figure 8), and is intended for use during shoreline acquisition or as necessary with vessels 2302 and 1706. The CVM vertical beam system can

utilize either a 4 degree or a smaller 9 degree 200 kHz side mounted transducer and has a depth range up to 180 meters (Figure 9). The CVM links directly into one Trimble Pathfinder® Pro XRS unit for positioning and provides a real-time bottom profile. Files are logged in Hypack as BIN files to obtain accurate depth records for the Shoreline NALL Buffer, VBES mainscheme, and/or VBES crosslines.



**Figure 8: Odom Echotrac CVM**



**Figure 9: Four degree (left) & nine degree transducers**

### 1.2.6 Klein Series 5000 Side Scan Sonar

The Klein Series 5000 Sonar System consists of a side scan sonar instrument-mounted towfish (Figure 10), a Transceiver and Processing Unit (TPU), and Windows-based computer for display and control, along with a tow cable and various interconnect cables. The 5000 series operates at a nominal frequency of 500 kHz (455 kHz actual) and has a depth rating to 200 meters. It is software driven on a PC platform employing Klein's SonarPro™ software. Files are logged in SDF format and converted into Caris HIPS and SIPS using the Conversion Wizard.

Preliminary testing of the Klein 5000 occurred in May 2009. Full testing and documentation will be conducted prior to data collection and system utilization.

The towfish can be used in one of two configurations, hull-mounted on launch 1018 or towed from *Fairweather*. In the hull-mounted configuration the towfish is bolted to a sled on the bottom of the launch. The sled is situated to port of the keel and is approximately centered fore and aft. In the towed configuration the towfish is fitted with a K-wing depressor and affixed to armored coaxial cable for deployment from *Fairweather's* A-frame. The amount of tow cable being used is manually entered into SonarPro™ for towfish layback calculation.



**Figure 10: Klein 5000 Side Scan Sonar**

### **1.3 Manual Sounding Equipment**

#### **1.3.1 Diver's Least Depth Gauge**

The diver's least depth gauge (DLDG) is a hand-held device that uses pressure to determine depth of water over a discrete point (e.g. mast of a shipwreck). A raw sounding obtained during a dive is corrected with verified tides and Conductivity/Temperature/Depth (CTD) information acquired in the vicinity of the object.

The divers least depth gauge (see Figure 11) was calibrated by PTC Electronics Incorporated on April 2, 2008, documentation is included in Appendix V. Prior to field season use on April 22, 2009, raw DLDG sounding with simultaneous lead line readings allowed for comparison measurements for check purposes to ensure appropriate readings, the associated Divers Least Depth Gauge Report is include in Appendix V. Depths acquired with the DLDG are processed using the same procedures as other shoreline features that require tide correction as described in section B.2.2 of this report.

During projects that required DLDG use, periodic quality assurance checks are conducted as outlined in section 1.5.6 of the *FPM*. Daily DQA checks and pre and post dive DQAs are performed. Documentation and DQA files are included with the individual descriptive reports with the Sound Speed DQA data for the particular surveys that required the use of the DLDG.



**Figure 11: Diver's least depth gauge**



### 1.3.2 Lead Lines

Vessels 1010, 1018, 1706, and 2302 are each equipped with a lead line. Lead lines are used for depth measurements near shore over submerged shoals and for echosounder depth comparisons.

Leadlines were created, measured and calibrated according to Section 1.5.3 of the *FPM* with the exception that the lines were calibrated to the meter instead of decimeter. Calibration was performed during April 2009. Calibration reports for the leadlines are included in Appendix V.

## 1.4 Positioning, Heading, and Attitude Equipment

### 1.4.1 TSS Positioning and Orientation System for Marine Vehicles (POS/MV)

*Fairweather* and her launches are each equipped with a TSS POS/MV 320 V4, configured with TrueHeave™. The POS/MV calculates position, heading, attitude, and vertical displacement (heave) of a vessel. It consists of a rack mounted POS Computer System (PCS) (Hardware Version 2.9-7 on *Fairweather* and version 2.6-7 on both Launches), a strap down IMU-200 Inertial Measurement Unit (IMU), and two GPS antennas corresponding to GPS receivers in the PCS. The port side antenna is designated as the primary receiver, and the starboard side antenna is the secondary receiver (see Figures 12 & 13). Differential correctors are supplied to the POS MV by a CSI wireless MBX-3S Automatic Differential GPS receiver. The POS MV firmware version 3.42 and the controller software version 4.0.2.0 are currently the installed versions utilized.

For all multibeam systems aboard *Fairweather* and her launches, timing between the sonar swath, position, heading and attitude information was synchronized by utilizing the proprietary UTC string from POS/MV 320 v.4's. A timing string is sent from the POS/MV to the RESON topside unit via serial connection and to the Hypack acquisition computer via ethernet. Vessel wiring diagrams are included in Appendix III.

POS/MV controller software was used to monitor position accuracy and quality during data acquisition. This ensured that positioning accuracy requirements are met, as outlined in section 3.2.1 of the *HSSD*. The POS/MV controller software provides clear visual indications whenever accuracy thresholds are exceeded.

### 1.4.2 POS/MV GAMS Calibration

GAMS (GPS Azimuth Measurement Sub-system) calibrations were performed on each of the three POS/MV units. The GAMS calibration procedure was conducted in accordance with instructions in chapter 4 of the *POSMV V4 Installation and Operation Guide*, 2005. Results are included in the individual vessel reports and spreadsheets, with calibration details located in Appendix III.



Figure 12: POS/MV antennas on 1018



Figure 13: POS/MV antennas on 1010

#### 1.4.3 CSI Wireless MBX-3S DGPS Receiver

*Fairweather* is equipped with commercial grade CSI Wireless MBX-3S DGPS Receivers that are used in conjunction with TSS POS/MV to provide vessel positioning during data acquisition. The DGPS receivers are configured in manual mode to allow reception of only one U.S. Coast Guard (USCG) differential GPS beacon station. Vessel wiring diagrams are in Appendix III-*vssl-5*.

Differential GPS (DGPS) is the primary method of real-time positioning. The individual descriptive reports list the U.S. Coast Guard beacon sites and frequencies used for differential corrections utilized during hydrographic surveying.

#### 1.4.4 Trimble Backpack

*Fairweather* uses two GPS Pathfinder® Pro XRS receivers in conjunction with a field computer to acquire detached positions during shoreline verification in the field. Data can also be collected with a handheld TSCe data collector. *Fairweather's* field computers are Panasonic Toughbooks. Currently in use are two CF-30's, one CF-29, one CF-19, and one CF-18. The receivers have integrated beacon/satellite differential antennas which allow access to digital real-time sub-meter accuracy solutions. Data quality assurance testing was conducted by *Fairweather* personnel in April 2009. Trimble units were tested over a published benchmark. Trimble positions matched the published benchmark position within 0.6m. Test results are located in Appendix V.



**Figure 14: Trimble Backpack Unit**

#### 1.4.5 Impulse LR Hand-held Laser

The Impulse Laser Rangefinder and TruPulse 200 Laser Rangefinder are used in conjunction with the Trimble Backpack GPS unit to acquire distances and heights during shoreline verification. These data are entered directly into the shoreline acquisition software and annotated on the detached position forms. The Impulse LR and TruPulse 200 Laser Rangefinder do not function properly in low light or in choppy seas when a feature is not distinguishable from surroundings.



**Figure 15: IMPULSE LR laser**



**Figure 16: TruPulse 200 Laser Rangefinder**

Data quality assurance testing was conducted in April 2009 by *Fairweather* personnel. Vertical and horizontal readings were taken with the laser rangefinders and compared to measurements taken with a steel tape. The laser rangefinder was set up on a tripod and a staff of known height was measured at distances of 10, 20, 50, and 100 meters. Three horizontal and three vertical readings were taken at each interval. The results of the laser rangefinder accuracy testing are located in Appendix V.

### 1.5 Sound Velocity Equipment

#### 1.5.1 SBE 19plus SEACAT Profiler

*Fairweather* is equipped with three SBE 19plus and two SBE 19plusV2 SEACAT sound velocity profilers used to acquire conductivity, temperature, and depth (CTD) data in the water column to determine the speed of sound through water. Two of the SBE 19plus profilers have pressure sensors rated to 1000 meters. The third SBE 19plus profiler has a pressure sensor rated to 3,500 meters. The two SBE 19plusV2 profilers have pressure sensors and units rated to 600 meters.

The SBE 19*plus* and SBE 19*plus*V2 SEACAT sound velocity profilers were calibrated by the manufacturer and current calibration files were returned with the units. Calibration files are located in Appendix V.

Periodic quality assurance checks include comparison casts between CTD instruments. Data quality assurance (DQA) checks include comparison casts between two instruments as per section 1.5.2.2.2 of the *FPM* for each survey. Records of the DQA tests performed are kept aboard the ship and are included with the digital Separates II – Sound Speed Data for each survey.

To ensure that the CTDs continue to function properly a stringent maintenance schedule is followed using guidelines from the manufacturer's recommendations. This includes a thorough rinsing of the instrument with distilled water after each cast and periodically each CTD is flushed with a Triton X-100 solution.

### 1.5.2 Moving Vessel Profiler 200

A Brooke Ocean Technology, Ltd. (BOT) Moving Vessel Profiler 200 (MVP200) is mounted in the aft starboard corner of the fantail (see Figure 15). The MVP200 system is a self contained sound velocity profiling system capable of sampling water column profiles to 200m depth from a vessel moving up to 12 knots. The system is configured with a Single Sensor Free Fall Fish (SSFFF) outfitted with an Applied Microsystems Ltd. Sound Velocity and Pressure Smart Sensor. Deeper profiles can be obtained by reducing the vessel speed. When the vessel is holding station, the system is capable of recording casts over 400m in depth.

The MVP system consists of a winch, cable, fish (the towed unit with the sound velocity sensor), support assembly, and controlling hardware and software. During ship acquisition, the fish is deployed using the on-deck controller and towed with enough cable out to keep the fish 3-5 m below the water surface. A “messenger” (a short cable-thickening sleeve) is set to allow the system to keep the appropriate amount of cable out and is reset as needed when the ship acquisition speed is altered.

During SVP acquisition, the controlling computer application, BOT MVP version 2.4 is used to control the MVP system and to acquire SVP data. MVP allows for three acquisition modes: 1) automatic continuous multiple cast freefall casting while at speed, 2) single cast freefall casting while at speed, and 3) single cast winch speed casting while stationary. The user limits the depth to which the fish will fall by setting 1) the depth-off-bottom and 2) the maximum depth. Either single, individually initiated casts can be performed at the discretion of the Hydrographer or the auto deploy function can be enabled and set with varying intervals (every 10 minutes, for example) for deployment.

On 19 August 2009 the MVP Controller software was updated to version 2.401.

*Fairweather* has three Applied Microsystems Ltd. Sound Velocity and Pressure Smart Sensors. All of the sensors were calibrated by the manufacturer and current calibration files were returned with the units. Calibration files are located in Appendix V.

Periodic quality assurance checks include comparison casts between the MVP and one of the SBE 19*plus* or SBE 19*plus*V2 SEACATs. Data quality assurance (DQA) checks include comparison casts among the instruments as per section 1.5.2.2.2 of the *FPM* for each survey. Records of the DQA tests performed are kept aboard the ship and are included with the digital Separates II – Sound Speed Data for each survey.



**Figure 17: Fairweather's MVP200 sound velocity system**

### 1.5.3 RESON Sound Velocity Probe (SVP 70)

*Fairweather* is equipped with one RESON SVP 70. The SVP 70 measures the speed of sound near the ship's hull mounted transducers to provide real time surface sound speed values. The unit is mounted adjacent to the RESON 8160 as shown in Figure 18.



**Figure 18: Fairweather's SVP 70 sound speed unit (left) and the 8160**

The sound speed is output to the RESON 8160's processing unit. The 8160 - a flat faced transducer - requires sound velocity information for beam forming. The 8160 cannot be used to acquire data without real time sound velocity information.

The unit was installed during the winter drydock period in Seattle at Lake Union Drydock Company. The current calibration report is included in Appendix V.

### 1.5.4 Odom Digibar Pro

*Fairweather* is equipped with one Odom Digibar Pro. The Digibar measures the speed of sound near the RESON 8125 on the sled attached to Launch 1018 to provide real-time surface sound speed values. The unit is mounted vertically just aft of the RESON 8125 on the sled as shown in Figure 19.



Figure 19: *Fairweather's* Odom Digibar Pro mounted on Launch 1018.

The sound speed is output to the RESON 8125 processing unit. The 8125 requires surface sound speed information for beam forming due to the flat faced transducer.

The unit was calibrated on April 16, 2009 and the current calibration report is included in Appendix V.

## 1.6 Vertical Control Equipment

### 1.6.1 Water Level Gauges

Five Sutron 8210 tide gauges were provided to *Fairweather* by the Center for Operational Oceanographic Products and Services (CO-OPS) at the start of the 2009 field season. These gauges are equipped with Paros Scientific Sensors for pressure measurements. The tide gauges are checked annually by CO-OPS Field Operations Division personnel to ensure that their accuracy standards are being met.

CO-OPS does not provide calibration or quality assurance documentation to the *Fairweather*. Installation and removal of the water level gauges is the responsibility of *Fairweather* personnel. To ensure full functionality of the vertical control equipment prior to deployment for field operations, new gauges undergo testing by *Fairweather* personnel. Five gauges underwent testing in April 2009 and results are included in Appendix V.

### 1.6.2 Leveling Equipment

*Fairweather* is equipped with four universal automatic levels (two Zeiss NI2 333 and two Leica NA2 100) and graduated metric staffs to assist in leveling tide gauges.

A Kukkamaki procedure is performed prior to leveling in order to verify the collimation error. Procedures used followed those described in the *User's Guide for the Installation of Bench Marks and Leveling Requirements for Water Level Stations*, October 1987. Kukkamaki results for 2009 are located in the Tides section of Appendix V.

## 1.7 Horizontal Control Equipment

*Fairweather* is equipped with two Trimble NetR5 receivers and one Ashtech Z-Xtreme dual-frequency GPS base stations used for the positioning of horizontal control marks, tidal benchmarks and aids to navigation. These base stations can be configured for use as a portable DGPS or RTK reference station, or as a static receiver to record observations for use with PPK.

When deployed for PPK the base stations log data locally, either to internal memory or external memory, and the data is downloaded periodically. The data is downloaded either by visiting the site or remotely via Freewave 900 MHz spread spectrum Ethernet radios. Station power needs are supported by batteries and solar panels.

The Ashtech antenna can be equipped with an optional ground plane and all receiver antennas are used with a Seco fixed height GPS tripod.

Data quality assurance (DQA) testing of the Ashtech receiver was performed April 30<sup>th</sup>, 2009 by *Fairweather* personnel. The receiver was installed over control mark "VIXEN HBR 2009" (NGS PID: BBBK46) in Ernest Sound, AK using a Seco fixed height tripod. The receiver acquired data for 8 hours. The recorded observations were submitted to OPUS. The OPUS position of the receiver was half a centimeter from the published position. The OPUS solution is included in Appendix V.

Data quality assurance testing of all three GPS units was performed May 1<sup>st</sup>, 2009 by *Fairweather* personnel. The receivers were set up over Benchmark No. 37 (NGS PID: AI4914) in Ketchikan, AK using a Seco fixed height tripod. Each receiver acquired data for 2 hours. The recorded observations were submitted to OPUS. The OPUS position of each of the two Trimble receivers was within three centimeters of the published position for the mark. The Ashtech receiver had a position over a decimeter from the published position; this is likely due to fewer satellites observed during the recording period as compared with the two Trimble receivers and the significantly shorter observation period as compared to the previous DQA testing. The OPUS solutions are included in Appendix V.

Horizontal control equipment serial numbers and installation dates are located in the hardware section of Appendix I, System Tracking.

## 2.0 Software

### 2.1 Software Systems Inventory

An extensive software inventory with documentation, of the software systems used by NOAA ship *Fairweather*, is maintained as a *Survey Software* spreadsheet and is included with the Supplemental Survey Records for the individual Descriptive Reports. This spreadsheet includes specifics such as software applications, versions, and hot fixes, in addition to dates loaded on specific computers within the survey department.

### 2.2 Data Acquisition Software

#### 2.2.1 HYPACK® HYSWEEP

*Fairweather* uses the Hypack® software package to acquire multibeam echo sounder and backscatter data on all of its multibeam platforms. Hypack is used to log VBES data, which is acquired in two formats: .BIN and .RAW (used for processing).

Hysweep is a module of the Hypack software suite that allows for real-time data planning and acquisition. Hysweep combines geo-referenced bathymetric digital terrain models and reference files such as raster charts and vector shoreline files to display real-time bathymetric bottom coverage. Data is acquired in three formats: .RAW, .HSX (containing bathymetry), and .81X (containing snippets data). All three file types are logged but only the .HSX and .81X files are utilized, stored, and submitted.

### 2.2.2 CARIS Notebook

CARIS Notebook™ can be used to directly collect detached shoreline positions and verify shoreline. The software is run on a field computer and receives the Trimble GPS data output from the GPS Pathfinder® Pro XRS receivers.

GPS settings in CARIS Notebook are as follows:

- Maximum Horizontal Dilution of Precision (HDOP) = 3
- Maximum Positional Dilution of Precision (PDOP) = 6
- Minimum Signal-to-Noise Ratio (SNR) = 12
- Minimum Elevation Mask = 8°
- Minimum # of Satellites = 4

Real-Time settings in CARIS Notebook are as follows:

- Source Type: Integrated Beacon – Manual Mode
- Position Mode: Corrected Only
- Age Limit: 20 seconds

Differential GPS correction is applied in real-time, using the unit's integrated beacon as the primary corrector. The unit can be setup to run without using DGPS with position mode set to "Autonomous Only" or with values different than those listed above. These special circumstances of acquisition with altered parameters are recorded and documented in the individual Descriptive Report as appropriate.

## 2.3 Data Processing Software

### 2.3.1 NOAA Hydrographic Systems and Technology Programs (HSTP) Software

Sound speed data is processed with Velocwin, in-house software produced and maintained by NOAA's Hydrographic Systems and Technology Programs (HSTP) division. Velocwin creates and archives water column profiles, performs quality assurance, and processes pressure based depth data. Velocwin creates a standard file format across NOAA's hydrographic fleet for sound speed profiles applied to shallow water multibeam and single beam data.

Pydro, another NOAA program produced and maintained by HSTP, is used to produce Smooth Tides Requests along with DTON and AWOIS Reports. In addition, PYDRO is used for Tidal Constituent and Residual Interpolation (TCARI) tide application in conjunction with CARIS HIPS.

### 2.3.2 CARIS

CARIS HIPS™ (Hydrographic Information Processing System) is used to process all multibeam data including data conversion, filtering, sound velocity, tide correcting, merging and cleaning. Vertical beam data is also



processed using CARIS HIPS, where .RAW data is converted, filtered, tide corrected, merged, and displayed in Fieldsheets. CARIS HIPS also calculates the Total Propagated Error (TPE) used to produce Bathymetry Associated with Statistical Error (BASE) surfaces which assist the Hydrographer in data cleaning, analysis, and to produce BASE surface deliverables.

CARIS SIPS™ (Sonar Information Processing System) is used to process all side scan imagery data including data conversion, slant-range correction, beam pattern correction, and despeckling, if appropriate. CARIS SIPS is also used to inspect the imagery for contacts and to produce side-scan imagery mosaics.

CARIS Notebook™ is used to compile and display source shoreline, shoreline updates and S-57 features that are collected directly in the field, digitized, or imported from Pydro. The .hob files created in Notebook are the current shoreline deliverables.

CARIS BaseEditor™ will be used for data quality assurance checks on the BASE surface deliverables. At the time of writing the software was not available to *Fairweather* personnel.

### **2.3.3 Fledermaus™**

Fledermaus™, an Interactive Visualization Systems 3D™ (IVS 3D) program, is used for data visualizations and creation of data quality control products, public relations material and reference surface comparisons.

As an additional data quality assurance check, Fledermaus™ is used to examine the CARIS surfaces prior to submission. The combined BASE surface is exported from CARIS and then converted to a Fledermaus .sd file via the Avggrid and Dmagic modules.

### **2.3.4 Geocoder**

The Geocoder program is provided by University of New Hampshire CCOM and another implementation is provided by Hypack. Our primary use of these programs is to produce imagery of gathered snippets and bathymetry data. Hypack's .81X and .HSX files are used to assemble snippets data and along with CARIS HIPS processed depths as xyz grids for digital terrain model production.

## **3.0 Vessels**

### **3.1 Vessel Inventory**

The NOAA Ship *Fairweather* (S220) and her survey launches 1010 and 1018 are equipped to acquire multibeam echosounder (MBES) and sound velocity profile (SVP) data. Launch 1018 is also the primary vessel for dive operations. The AMBAR (2302) and Monark (1706) are used during shoreline verification, bottom sampling, and horizontal and vertical control operations. All vessels may be used in support of tide gauge operations. See Appendix I for the complete vessel inventory.

### **3.2 Noise Analysis**

The *Fairweather* sonar systems, RESON 8160 and RESON 8111ER, underwent noise analysis testing on October 10 and 11, 2004 respectively. The results are used during acquisition to enhance data quality and are included in Appendix III-S220-7. Standard operating procedures utilizing the RESON 8160 and RESON 8111ER aboard the *Fairweather* have survey speeds set to minimize noise based on these noise analyses.

## **4.0 Data Acquisition**

### **4.1 Horizontal Control**

A complete description of horizontal control will be included in the project's *Horizontal and Vertical Control Report (HVCR)*, submitted for each project under separate cover when necessary as outlined in the *HSSD* and section 5.2.3.2.3 of the *FPM*.

The horizontal datum for all projects is the North American Datum of 1983 (NAD83) unless otherwise noted in the individual descriptive reports.

Multibeam and shoreline data are differentially corrected in real time using correctors provided by Coast Guard beacons. The specific beacons used for a given survey will be included in the Horizontal Control section of the survey's descriptive report. If loss of the differential beacon resulted in any data being recorded with C/A GPS positions it will be noted in the Descriptive Report for the specific survey.

If DGPS is commonly lost during the survey, the original navigation of the survey vessel can be replaced with a post processed kinematic (PPK) single best estimate of trajectory (SBET). The PPK solution is dependent on a local base station supported by the ship and processed in Applinix POSPac software using Single Base mode. The resulting navigation from PPK is an improvement over C/A and DGPS navigation. The use of PPK for a given survey will be included in the Horizontal Control section of the survey's descriptive report.

#### **4.2 Multibeam Echosounder Acquisition and Monitoring Procedures**

Methods of acquisition took into consideration system performance limitations, the bottom topography, water depth, and the ability of the vessel to safely navigate the area.

All multibeam data are acquired in Hypack's HYSWEEP® SURVEY extension (HSX) format and monitored in real-time using the 2-D and 3-D data display windows and the on-screen displays for the RESON SeaBat 8101ER, 8111ER, and 8160. Adjustable parameters that are used to control the RESON either directly or from the Hypack software include range scale, power, gain, and pulse width. These parameters are adjusted as necessary to ensure best data quality. Vessel speed was predominantly between 6-6.5 knots and reduced as needed to eliminate noise from the data and to ensure the required along-track coverage for object detection in accordance with the *HSSD*. Survey personnel follow standard operating procedures documented aboard the *Fairweather* while setting and utilizing the RESON systems and Hypack for acquisition of data.

Mainscheme multibeam sounding acquisition lines using the RESON SeaBat 8101ER, 8111ER, and 8160 are generally run parallel to the contours and spaced no greater than three to four times the water depth and in most cases at a tighter line spacing to ensure the appropriate data density for a given resolutions at a given depth range. For discrete item developments, line separation was reduced to 2 times water depth to ensure least-depth determination by multibeam near-nadir beams. Hypack Hysweep was used in lieu of planned line files. Hysweep displays the acquired multibeam swath during acquisition and was monitored to ensure overlap and full bottom coverage. If coverage was not adequate, additional lines are run while still in the area.

#### **4.3 Shoreline Verification**

*Fairweather* personnel conduct field shoreline verification at times near predicted low water, in accordance with the Project Instructions and section 3.5 of the *FPM*.

The composite source file (CSF) provided with the project instructions is the primary source for shoreline features to be verified. Additionally, AWOIS items and other features to be investigated are provided for a given survey and are included in the files utilized during shoreline verification. Specific details regarding the composite source and investigation features are included in the individual descriptive reports.

A Mean High Water (MHW) Buffer line, offset 0.8 mm at the scale of the largest chart in the area, is provided with the project instructions or created from the composite source MHW line. This MHW Buffer line is used in the shoreline acquisition software and on the boat sheet as a reference, and to determine the Navigable Area Limit Line (NALL). The NALL is determined in the field as the farthest off-shore of either the MHW buffer specified above, the 4-meter depth contour, or the inshore limit of safe navigation. All shoreline features from the

composite source seaward of the Navigable Area Limit Line (NALL) are verified (including an update to depth and/or position as necessary) or disproved during shoreline operations. Features off-shore of the NALL and not addressed or features of an ambiguous nature are flagged with a marker note for further clarification.

Detached positions (DPs) acquired during shoreline verification indicate new features, revisions to source features, or source features not found in the field. They are recorded in the shoreline acquisition software and on DP forms.

## 5.0 Bottom Sample Acquisition

Bottom samples are acquired according to section 7.1 of the *HSSD*. Samples are acquired using the current shoreline acquisition system and processed similarly to other shoreline features as outlined in the Descriptive Report for the specific survey. Bottom sample results are included in the Notebook .hob deliverable layer, HXXXXX\_Final\_Feature\_File.

## B QUALITY CONTROL

The *Fairweather* has numerous standard operating procedures (SOPs) that are followed by personnel throughout the survey to ensure consistent high quality data and products.

### 1.0 Uncertainty Modeling

Error values for the multibeam and positioning systems on *Fairweather* and her survey launches were compiled from manufacturer specification sheets for each sensor (Heave, Pitch, Roll, Position, and Heading) and from values set forth in section 4.2.3.6 and Appendix 4 – CARIS HVF Uncertainty Values of the *FPM*.

Estimates for the Motion Reference Unit (MRU) alignment errors are the standard deviations of the values determined by multiple personnel processing the patch test data (see section C 4.0). Initial MRU values were significantly large and impacted the Total Propagated Uncertainty/Error (TPU/TPE) values in CARIS inappropriately. Final MRU values used did not include the outlier patch test values to allow for more reasonable MRU uncertainty and CARIS TPE values.

The *Fairweather* TPU Values spreadsheet located in Appendix IV, lists the final uncertainty values for *Fairweather* and her launches, including the default tides and sound velocity values. Uncertainty values relating to vessels and survey systems are entered into the HIPS Vessel File (HVF) for each platform. The tidal errors for the gauge and for zoning are determined on a project by project basis. Sound speed uncertainties for a given survey are based upon either the defaults listed in the TPU value spreadsheet or based on utilization of NOAA sound speed uncertainty estimation software. Survey specific uncertainty values for tides and sound speed that are entered during the Compute TPE step in CARIS HIPS and how they were determined will be included in the individual Descriptive Report.

### 2.0 Data Processing

#### 2.1 Multibeam Echosounder Data Processing

Bathymetry processing followed section 4.2 of the *FPM* unless otherwise noted.

Raw HSX multibeam data are converted to Caris HDCS format using established and internally documented settings. True heave, sound velocity and water level data are then applied to all lines and the lines merged. Once lines are merged Total Propagated Error (TPE) was computed.

The data acquired by the systems aboard *Fairweather* and her launches do not provide adequate densities to allow for representation at the resolutions and depth ranges specified in Hydrographic Technical Directive (HTD) 2009-2. A waiver from this specification was obtained from Jeffrey Ferguson, Chief, Hydrographic Surveys Division to

*Fairweather* on May 19, 2009 and is included in Appendix VI. The general resolution, depth ranges, and CUBE parameter settings outlined in the waiver and used for processing are listed in Table 1. These values may also require adjustment by sheet managers for individual surveys to address visualization gaps between finalized surfaces in areas of greater slope. The lesser depth range value of a coarser grid will be adjusted shoaler if adjustment is necessary (ie 35-80m for an 8m resolution adjusted to 30-80m). Adjustments to the depth ranges will be communicated to and agreed upon with the appropriate processing branch prior to data submission. A detailed listing of the actual depth ranges used during the processing of each survey, along with the corresponding fieldsheet(s), will be provided in the Descriptive Report of each survey.

BASE surfaces are created using the Combined Uncertainty and Bathymetric Estimator (CUBE) algorithm and parameters contained in the NOAA Cubeparams.xml file as provided with (HTD) 2009-2. The Cubeparams.xml will be included with the HIPS Vessel Files with the individual survey data. The NOAA parameter configurations for resolutions 1-16 meters are used as listed in Table 1.

Surface Resolutions		CUBE Parameters
Depth Range	Grid Resolution	Configuration Name
0 to 23 meters	1 meter	NOAA_1m
18 to 40 meters	2 meter	NOAA_2m
35 to 80 meters	4 meter	NOAA_4m
75 to 160 meters	8 meter	NOAA_8m
155+ meters	16 meter	NOAA_16m

**Table 1: Resolutions and Depth Ranges**

Multibeam data are reviewed and edited in HIPS swath editor and in subset mode as necessary. The finalized BASE surfaces and CUBE hypotheses are used for directed data editing at the appropriate depth range in subset editor. The surfaces and subset editor viewing are also used to demonstrate coverage and to check for errors resulting from tide, sound velocity, attitude and timing.

Vessel heading, attitude, and navigation data are reviewed in HIPS navigation editor and attitude editor if deemed necessary upon review of surfaces. Where necessary, fliers or gaps in heading, attitude, or navigation data are manually rejected or interpolated for small periods of time. Any editing of this nature will outlined in the Descriptive Report for the particular survey.

The Surface Filtering functionality in HIPS may be used in the processing of survey data to reject errant soundings. If utilized, the individual Descriptive Report shall list the confidence level settings for standard deviation used and discuss the particular way the surface filter was applied.

In areas of navigational significance, depths less than 30 meters, where the BASE surface did not depict the desired depth for the given area, a designated sounding was selected. Designated soundings are selected as outlined in section 5.1.1.3 of the *HSSD*.

Layers determining “IHOness” are added to the CUBE surfaces allowing the Hydrographer to see where and if the surfaces meet IHO Order. The process is easily performed in HIPS and allows the Hydrographer to identify problem areas and determine the severity of the situation. This is a spatial quality control check rather than just a statistical list of nodes and allows for specific areas with problems to be isolated and addressed.

IHO surfaces are utilized during data collection as an additional child layer of the finalized surfaces to indicate problem areas that need attention. Additionally, IHO child layer(s) are included with the submitted surface(s).

The combined surface's IHO layer exported from CARIS is examined to allow the Hydrographer to see the full data distribution rather than just the minimum and maximum values in the surface. This data distribution is used to assess the quality of the survey. Ninety-five percent of the data is highlighted in the histogram which allows the Hydrographer to show whether the data for a given survey meets the appropriate IHO order as specified in section 5.1.1.1 of the *HSSD*. An image of the histogram and/or its derived statistics will be included with the Descriptive Report for the specific survey.

Additionally, a combined surface is reviewed in Fledermaus or CARIS Base Editor to ensure that the data are sufficiently cleaned for submission.

## 2.2 Shoreline Data Processing

During shoreline verification, field detached positions (DP) are acquired with CARIS Notebook. Tide application for features requiring tide correction is applied in CARIS Notebook when using discrete zoning and via Pydro when TCARI is to be used.

An original composite source file (H#####\_Original\_Composite\_Source.hob), clipped to the sheet limits for a particular survey, is saved prior to being edited and is submitted with the individual survey. New features and any updates to the composite source shoreline, such as ledges or reefs, are acquired or digitized with S57 attribution and reside in the H#####\_Final\_Feature\_File.hob. Updates to a source shoreline feature primarily include a change in depth/height, position, or S57 classification. Notebook's editing tools are used to modify source feature extents or positions.

The SORIND and SORDAT S57 attribute fields for new features or modified source features are updated to reflect the information for the associated survey number and date. All new or modified features are S57 attributed as applicable. All unmodified source features retain their original SORIND and SORDAT values.

Short descriptive comments taken from the boat sheets or DP forms along with investigation or survey methods are listed under the Remarks field. For significant features that deserve additional discussion or disapprovals, the Hydrographer included recommendations to the cartographer in the Recommendations field, along with the Hydrographer notes and investigation methods provided in the Remarks field.

Features that are disapproved or that do not adequately portray the shoreline are moved to the H#####\_Disprovals.hob layer from the H#####\_Final\_Feature\_File.hob layer. Features in the disapprovals layer retain their original SORIND and SORDAT values.

Photos labeled and associated with a DP number are included with the survey data and stored in the CARIS/Notebook photo folder with the deliverables.

AWOIS investigation items are received in the Project Reference File and investigated as necessary. Shoreline features correlated to the AWOIS item are included in either the H#####\_Final\_Feature\_File.hob or H#####\_Disprovals.hob layers and labeled with the appropriate AWOIS number and include a remark and recommendation from the Hydrographer.

The CARIS Notebook files along with CARIS HIPS BASE surface(s) are viewed to compare soundings and features simultaneously. Standard operating procedures, for processing shoreline features in CARIS Notebook, are followed by survey personnel aboard NOAA Ship Fairweather as outlined in section 4.4 of the *FPM*. A detailed discussion of the procedures used and any deviations in shoreline processing from standard procedures or the *FPM* are documented in the individual Descriptive Reports.

Final Shoreline Deliverables may include a report in spreadsheet format of features named the H#####\_Tabulated\_Features\_Listing included in Appendix II of the individual Descriptive Reports and up to three Notebook HOB files:

HXXXXX\_Original\_Composite\_Source,  
HXXXXX\_Final\_Feature\_File,  
HXXXXX\_Disprovals.

### 3.0 Data Review

Specific procedures are used on *Fairweather* to ensure quality control of data throughout acquisition, processing, and submission. These procedures are documented and followed by the Hydrographer. A detailed Quality Control Check is performed by the survey manager. A detailed Review is conducted by qualified survey personnel (FOO, CST, SST, or PS) other than the survey manager as an outside review of the survey data and deliverables. Submission checklists are used to ensure that all data and deliverables are complete and included upon submission. Documentation of these tasks is completed for every survey but only the final processing log, HXXXXX\_Data\_Log, is submitted with the individual survey data.

## C Corrections to Echo Soundings

### 1.0 Vessel HVFs

CARIS HIPS Vessel Files (HVF) are created by *Fairweather* personnel and used to define a vessel's offsets and equipment uncertainty. The HVF is used for converting and processing data collected by each survey platform. The HVFs used for a given project are included with the digital data submitted with those surveys.

### 2.0 Vessel Offsets

Sensor offsets are measured with respect to each vessel's reference point. The reference point for *Fairweather* and survey launches 1010 and 1018 is the IMU. Specific offset values are input into the POS/MV and the CARIS HIPS Vessel File (HVF).

A ship survey was completed for the *Fairweather* by Westlake Consultants, Inc on September 23, 2003. A POS/MV components spatial relationship survey of the *Fairweather* was conducted by National Geodetic Survey (NGS) in February 2007. An additional POS/MV components spatial relationship survey was conducted by NGS on February 15, 2009 while the ship was at Lake Union Drydock in Seattle, WA. The results of these surveys were used to determine the offsets for the ship. The reports from each survey are located in Appendix III. The S220 *Offsets & Measurements* spreadsheet is also included in Appendix III, listing the final values for *Fairweather*'s offsets with explanations of how they were calculated.

Permanent control points were established on launches 1010 and 1018 in July of 2004. Sensor offsets were measured by *Fairweather* personnel according to documented procedures. Total stations were utilized for positioning the permanent control points (see Figure 20). The total station specifications are located in Appendix II, the calibration certificates for the *Nikon DTM 310* and the *Sokkia SET 5F* are included in Appendix V. A steel tape was used to verify and update specific vessel offsets in March 2009 and the results are located in the respective vessel's *Minimum Physical Measurements\_2009* spreadsheet in Appendix III-101X-1. The final offsets for survey launches 1010 and 1018 are derived from a combination of values from the original full survey and the values updated in the verification surveys. The 2009 transducer measurement values indicated agreement with the 2008 values. Since the angle bias was not documented during 2009 measurement the 2008 offset values were used. Additionally, the values in the POSMV for the distances between the IMU to the Port Antenna and Heave point remained those used in 2008 and were not updated with the 2009 measurements for both launch 1010 and 1018. Though this creates a slight difference to the lever arm in the POSMV, no appreciable effects have been observed. The measurements, derivations, descriptions of methodology used, diagrams, and coordinate system references are included in the respective vessel's *Offsets & Measurements* spreadsheet in Appendix III-101X-1.

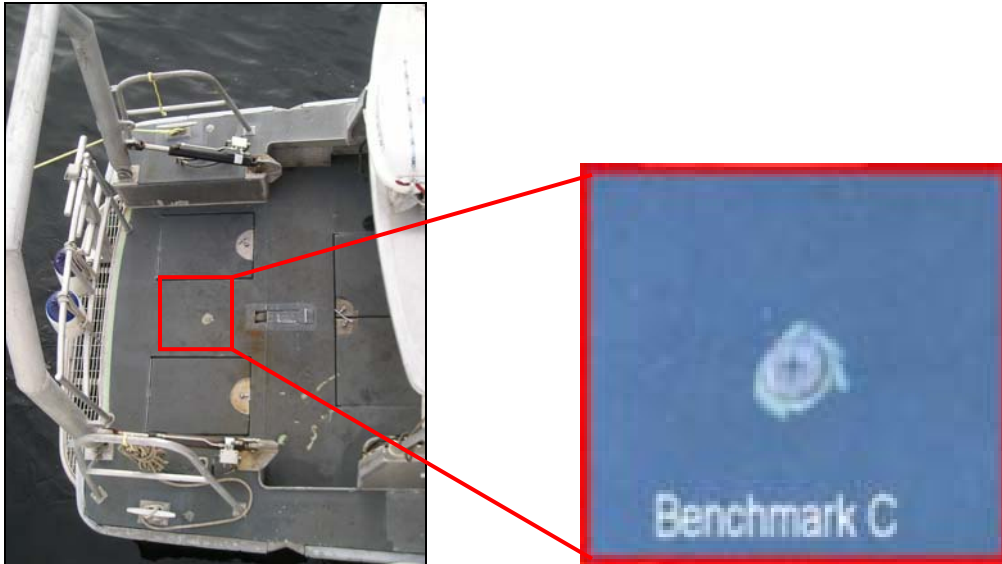


Figure 20: Permanent Control Point "Benchmark C" on launch 1018

### 3.0 Static and Dynamic Draft

The static drafts (*Waterline Height* in the HVF) for launch 1010 and 1018 were calculated based on steel tape measurements of the distance from benchmarks on the port and starboard quarter of the vessel to the waterline.

The bow and stern draft marks were used to perform a linear interpolation of the static draft at the *Fairweather's* IMU. The static draft was measured under different loading conditions: with different amounts of fuel. The *Ship Draft 2009* spreadsheet records the static draft values and is included with the ship offset documentation in Appendix III-S220-1.

The values and calculations for static draft are listed in each vessel's *Minimum Physical Measurements and Offsets & Measurements* spreadsheets located in Appendix III-vssl-1.

Dynamic Draft measurements were conducted for *Fairweather* in February 2009, and for survey launches 1010 and 1018 in April of 2009. The measurements were made using the change in ellipsoid height while traveling at different speeds in Lake Washington. The ellipsoid heights were determined using Post Processed Kinematics (PPK) by recording POSPac on each vessel and then processing the data with local reference stations in Applanix POSPac software. The resulting Single Best Estimate of Trajectory (SBET) was exported from POSPac and the speed versus ellipsoid height was fit to a polynomial curve using a least squares fit method in a Python Script written by ship's personnel. The polynomial curve was used to derive the table used in the CARIS HVF's for the Reson 8101 multibeam that are swing-arm mounted to both launches 1010 and 1018, and the standard deviation of the residuals was used to determine the associated uncertainty in the measurement. A written report about the initial measurements carried out in February is provided for in *Fairweather's* 2009 HSRR along with spreadsheets containing applicable graphs and tables with comparison to previous years for launches 1010 and 1018. Documentation for the dynamic draft testing is located in the respective vessel's folder in Appendix III. Launch 1018 also completed a traditional bottom referenced dynamic draft measurement, and the results from this test are plotted in the ellipsoidally referenced graph.

The dynamic draft measurement for Launch 1018 taken in February 2009 was conducted without the mounting sled and Reson 8125 multibeam sonar head mounted to the hull of the vessel, which was mounted for the first time in May 2009. A new dynamic draft measurement specifically for the Reson 8125 and sled mount configuration was taken on August 7, 2009, in Dutch Harbor, AK, using the "Echosounder method" described on page 31 of the FPM. The applicable acquisition, processing, and analysis spreadsheet is contained in Appendix III. The dynamic draft values entered in the CARIS HVF for Launch 1018 are the derived values from this

measurement. All data acquired during the 2009 field season to date with the Reson 8125 mounted to Launch 1018 has been corrected using these values.

#### 4.0 Patch Tests

Patch tests were conducted in April 2009 on *Fairweather* for the RESON 8111 and 8160 multibeam acquisition systems. Survey launches 1010 and 1018 with RESON 8101 transducers were also tested in April 2009. Survey launch 1018 can be outfitted with an 8125 transducer attached via sled mount. Since this system is detachable a patch test is conducted after each reattachment. The 8125 has had a patch test conducted in May 2009 during the Ernest Sound (O119) project and in June 2009 during the Shumagin (P183) project. Additional patch tests will be conducted after remounting of the 8125 sled and as necessary for the other systems. The results of all patch tests to date, along with the acquisition and processing logs, are included in the individual MBES Calibration files in Appendix III-*vssl-4*. Also included in Appendix III is the Sounding System Comparison. This comparison includes leadline to MBES comparisons and surface differencing between MBES reference surfaces. Average differences between systems are less than one meter.

#### 5.0 Attitude

All attitude corrections are generated by the POS/MV using data from the IMU-200 Inertial Measurement Unit (IMU). All attitude data are applied in post-processing in HIPS for systems acquiring data with the RESON 8101, 8111, and 8125. The RESON 8160 has real-time roll and pitch stabilization applied, thus these components of attitude were not applied in post-processing as to not double apply the correctors.

IMU values for uncertainty of heave, pitch and roll are included in the manufacturer specification in Appendix II and are included in the *Fairweather\_TPE Values\_2009* spreadsheet located in Appendix IV.

#### 5.1 True Heave

*Fairweather* and her launches are equipped with the POS/MV TrueHeave™ (TH) option. True Heave™ is a ‘delayed’ heave corrector as opposed to ‘real time’ heave corrector and is fully described in Section 6 of the *POS/MV Version 4 Installation and Operation Manual*. TrueHeave is logged along with other POSpac data in the daily POS files (2009-ddd\_vssl\_000) through the Ethernet Logging function in the POS/MV controller software. To ensure proper calculation of TH, files are logged for at least three minutes past the end of each day’s survey operations.

During daily processing the occurrence of “corrupted” TrueHeave files can occur. This is generally due to a formatting problem in the POS file. A fix has been provided by CARIS in a tool called “fixTrueHeave.exe.” In cases where this is necessary a new “fixed” file is created with the extension “.fixed” (2009-ddd\_vssl\_000.fixed). The new fixed True Heave file is then applied to the data in the CARIS HIPS program. The original corrupted file is retained along with the fixed file with the raw data. Occurrences of this for specific surveys are noted in the individual Descriptive Reports.

In cases where TrueHeave™ could not be applied, real time heave correctors are used. Real time heave data are recorded in Hypack/Hysweep software and stored in the .HSX format and can be applied as the heave corrector for multibeam data. Data that does not have TrueHeave™ applied will be listed in the individual Descriptive Report for the survey.

#### 6.0 Sound Velocity

SBE 19*plus* and SBE 19*plus*V2 sound velocity profilers are used regularly to collect sound speed data for the RESON 8101 and RESON 8125 multibeam sonars on survey launches 1010 and 1018 and used on an as needed basis for the *Fairweather*’s RESON 8111 and 8160 multibeam systems. The Brooke Ocean Technology Moving Vessel Profiler (MVP) is primarily used to collect sound velocity data for sound speed correction of data acquired with *Fairweather*’s RESON 8111 and 8160 multibeam systems.



Daily sound speed profiles from the SBE 19*plus* and SBE 19*plus*V2 profilers are processed with Velocwin and concatenated into single .svp files for each vessel per survey. Individual .svp files and the concatenated vessel files for the survey are submitted with each survey.

Sound speed profiles acquired using the Brooke Ocean Technology Moving Vessel Profiler 200 (MVP) are stored in files labeled .001, .001c, .001d, and .001e (collectively called BOT files) where the number increments by one with each subsequent cast. The .00#c file for each cast was opened with Velocwin and converted into CARIS .svp file format. The individual .svp profiles are concatenated into vessel specific .svp files for the entire survey. Individual sound velocity profile files taken by the MVP will not be submitted due to the large number of casts acquired; however, the daily concatenated files are submitted for backup purposes.

The concatenated sound velocity files are applied to multibeam data in CARIS HIPS during data processing. CARIS HIPS uses one of four different algorithms to automatically apply a sound velocity profile stored in a concatenated sound velocity file. They are: “previous in time,” “nearest in time,” “nearest in distance” and “nearest in distance within time.” In general, “previous in time” is the method used for applying sound velocity information in HIPS for launch data and “nearest in distance within time” is used for ship data, although the other methods may be used in certain situations. The method of applying sound velocity is included in the processing logs that are submitted with each survey.

## **7.0 Water Level**

The vertical datum for projects conducted is Mean Lower Low Water (MLLW). Predicted, preliminary, and/or verified water level correctors from the primary tide station(s) listed in the project letter instructions may be downloaded from the CO-OPS website and used for water level corrections during the course of the project. These tide station files are collated to include the appropriate days of acquisition and then converted to CARIS .tid file format using FetchTides or HydroMI in MapInfo.

Water level data in the .tid files are applied to data in CARIS HIPS using the zone definition file (.zdf) or a Tidal Constituent and Residual Interpolation (TCARI) model supplied by CO-OPS. Upon receiving final approved water level data, all data are reduced to MLLW using the final approved water levels (smooth tides) as noted in the Descriptive Report included with the survey data.

A complete description of vertical control utilized for a given project can be found in the project specific *Horizontal and Vertical Control Report (HVCR)*, submitted for each project under separate cover when necessary as outlined in section 5.2.3.2.3 of the *FPM*.



**Addendum to  
Fairweather 2009  
Data Acquisition & Processing Report**



**ADDENDUM CONTENTS**

**A EQUIPMENT**

**Addendum to section 1.2 - Echo Sounding Equipment**

1.2.1 RESON 7111 Multibeam Echosounder (MBES) ..... Adm-1

1.2.7 RESON 7125 Multibeam Echosounder (MBES) ..... Adm-1

**Addendum to section 1.4 - Positioning, Heading, and Attitude Equipment**

1.4.2 POS/MV GAMS Calibration ..... Adm-1

**Addendum to section 1.5 - Sound Velocity Equipment**

1.5.5 RESON Sound Velocity Probe (SVP 71) ..... Adm-2

**Addendum to section 3.1 - Vessel Inventory** ..... Adm-2

**B QUALITY CONTROL**

**Addendum to section 1.0 - Uncertainty Modeling** ..... Adm-2

**C CORRECTIONS TO ECHO SOUNDINGS**

**Addendum to section 2.0 - Vessel Offsets** ..... Adm-2

**Addendum to section 3.0 - Static and Dynamic Draft** ..... Adm-3

**Addendum to section 4.0 - Patch Tests** ..... Adm-3

**APPENDICES - CHANGES AND ADDITIONS LIST**

**Appendix I - CHANGES**

- Vessel Inventory – Information for *Rainier* launches 2801 and 2802 added
- Hardware Inventory - Additional equipment added, including equipment for *Rainier* launches 2801 and 2802

**Appendix II - ADDITIONS**

- 1.a.ii.1 - 7111 specs
- 1.a.iv - 8125 specs
- 1.a.v - 7125 specs

**Appendix III - CHANGES**

- 1010
  - Sections 1 through 5 - Reordered and removed duplicate documents for clarity
  - 1.b. - Updated 2009 Phase Center Minimum Physical Measurements sheet to display formula entries correctly
- 1018
  - Sections 1 through 5 - Reordered and removed duplicate documents for clarity
- S220
  - Sections 1 through 6 - Reordered and removed duplicate documents for clarity
  - 2. – Updated wire diagram for the single 8111 / 8160 setup (rev 4.0)

**ADDITIONS**

- 1010
  - 1.a. - IMU to Heave offset explanation
  - 1.a. - Offset adjustments due to Aug 2009 antenna replacements
  - 1.b. - 2008 Phase Center Minimum Physical Measurements sheet, used in 2009 offsets
  - 3. - POS GAMS Report Aug 2009
- 1018
  - 1.a. - Offsets for 8101 included, left out of initial submission
  - 1.a. - Offset adjustments due to 8125 incorrect phase center location, June 2009
  - 1.b. - 2008 Phase Center Minimum Physical Measurements (8101) sheet, used in 2009 offsets
  - 1.b. - Phase Center Minimum Physical Measurements (8125) sheet, new offset values listed
  - 4. - Dn 144 Patch test documentation for 8125 included, left out of initial DAPR submission
- 2801
  - Sections 1, 2, 4, 5 – Offset, Wire Diagram, Patch Test, and Dynamic Draft documents
- 2802
  - Sections 1, 2, 4, 5 – Offset, Wire Diagram, Patch Test, and Dynamic Draft documents
- S220
  - 2. - Wire diagram for the dual 7111 / 8160 setup (rev 1.0)
  - 4. – MBES Calibration Table for the 7111 (Patch Test, Oct 6, 2009)
- Sounding System Comparison Apr-July 2009 – mentioned in initial DAPR version but not included

**Appendix IV - CHANGES**

- FA TPE sheet
  - 1018 Reson 8125, offset and MRU values adjusted, previous values listed also
  - entries for 2801\_200kHz, 2801\_400kHz, 2802\_200kHz, and 2802\_400kHz included
- Tide and Sound Speed-Compute TPE Values - remainder of projects added

**Appendix V and VI - No Changes, No Additions**

Process Owner: <b>Survey</b> Updated: <b>12/16/2009</b>	Approval: <b>CO Fairweather</b> Approval Date: <b>2009</b>	
--	---	--



**Addendum to  
*Fairweather* 2009  
Data Acquisition & Processing Report**



## **ADDENDUM**

The following documentation is an addendum to the Data Acquisition and Processing Report previously submitted by NOAA Ship *Fairweather* for Hydrographic projects surveyed in 2009. Changes described below were in effect as stated below through the end of the 2009 field season.

### **A EQUIPMENT**

#### **Addendum to section 1.2 - Echo Sounding Equipment**

##### **1.2.1 RESON 7111 Multibeam Echosounder (MBES)**

The top side unit of *Fairweather's* RESON SeaBat 8111 MBES was replaced with a 71-P model (P/N 85101802, S/N2009003) on October 3, 2009. The 8111 transducer remains an 100 kHz multibeam system with swath coverage of 150°. The system is set at 301 discrete beams and run with the vertical beam width set at 1.5°. The typical operational depth range for the system is 20 to 350 meters. Specifications and system information were added to the Hardware Inventory and Equipment Specifications Listing as changes and additions to Appendix I and II respectively.

##### **1.2.7 RESON 7125 Multibeam Echosounder (MBES)**

Survey launches 2801 and 2802 were received from the NOAA Ship *Rainier* on September 27, 2009. They are each equipped with a RESON SeaBat 7125 MBES and snippet option. The RESON 7125 has both low frequency (200kHz) and a high frequency (400kHz) head. The 200 kHz multibeam system with a swath coverage of 150°. The swath is made up of 101 discrete beams with an along-track and across-track beamwidth of 1.5°. The typical operational depth ranges for the RESON 7125 operating with the 200kHz system is 3 to 100 meters and 3 to 400 meters operating at 400kHz. No calibration information was provided by the manufacturer for the system. Each system is hull mounted along the centerline. Specifications and system information were added to the Hardware Inventory and Equipment Specifications Listing as changes and additions to Appendix I and II respectively. Offset reports, calibration information, and other documentation were either provided by *Rainier* personnel or created by *Fairweather* personnel and are included as additions to Appendix III.

#### **Addendum to section 1.4 – Positioning, Heading, and Attitude Equipment**

##### **1.4.2 POS/MV GAMS Calibration**

Both the port and starboard antennas mounted on launch 1010 for the POS/MV were replaced on August 23, 2009. The antenna mounting hardware, which is 4cm in height, had to be removed. A new GAMS (GPS Azimuth Measurement Sub-system) calibration was performed on the same day on the launch 1010 POS/MV unit in accordance with instructions in chapter 4 of the *POSMV V4 Installation and Operation Guide*, 2005. Offset documentation, results and calibration details are included as additions to Appendix III.

GAMS calibrations were performed by *Rainier* personnel on launches 2801 and 2802 on March 10, 2009. Results and further calibration details were not provided to *Fairweather* and therefore are not included in the appendices.

## Addendum to section 1.5 - Sound Velocity Equipment

### 1.5.5 RESON Sound Velocity Probe (SVP 71)

*Rainier* launches 2801 and 2802 are each equipped with a RESON SVP 71. The SVP 71 measures the speed of sound near the transducer to provide real time surface sound speed values to the RESON 7125's processing unit. The units are hull-mounted adjacent to the RESON 7125's transducers as shown in Figure 21.



Figure 21: SVP 71 sound speed unit (top) and a RESON 7125

## Addendum to section 3.1 – Vessel Inventory

*Fairweather* (S220) obtained two additional *Rainier* MBES capable launches for use after September 27, 2009. A complete and updated vessel inventory is included as a change to Appendix I.

## B QUALITY CONTROL

### Addendum to section 1.0 – Uncertainty Modeling

The *Fairweather* TPU Values spreadsheet was updated to include the addition of launches 2801 and 2802 and the changes in offsets for launch 1010. The TPU values for launches 2801 and 2802 are a combination of the standard deviation values obtained from *Rainier* (Offset, Waterline) and values normally used on board *Fairweather* (POSMV, MRU). The Navigation to Transducer offsets for launches 2801 and 2802 were calculated from the appropriate vessel offset report and included in the TPU Offsets section of the hvf. All values in the modified version have been applied to the appropriate hvf and the full spreadsheet is included as a change to Appendix IV.

## C Corrections to Echo Soundings

### Addendum to section 2.0 – Vessel Offsets

Launch 1010 had both the port and starboard antennas replaced on August 23, 2009. The removal of the 4 cm, in height, mounting hardware necessitated a re-measurement of the port antenna to the inertial measurement unit (IMU) values. Updated offset values were entered in the POS/MV for calibration and acquisition. The TPE Value Offsets for Nav to Transducer in the 1010 CARIS HIPS Vessel File (HVF) were not updated with this change, due to the negligible impact on the TPE values for the affected data. Offset documentation is included as an addition to Appendix III.

The offsets for launch 1018 configured with the RESON 8125 were reassessed and re-measured due to the initial measurements using an incorrect position for the phase center. This discrepancy occurred because of the use of an

out-of-date manual. The bow-stern measurements were changed to the correct phase center by subtracting 12.1 cm (the distance from the receive array to the center) and 7.1 cm (half the width of the receive array) from the original measurement. The HVF offset values were adjusted for data collected on Dn 155 (June 4, 2009) and later as earlier data had already been submitted. These offset adjustments are documented as additions to Appendix III.

Vessel offsets for launches 2801 and 2802 were conducted and provided by *Rainier* personnel and are dated as April 9 and 10, 2008. The vessel offset reports are included as additions to Appendix III. Offset measurements are derived from the NGS conducted survey results and the sonar mounting bracket blueprints. The reference points (RP) for survey launches 2801 and 2802 are the motion reference units (MRU) also referred to as IMU. Specific offset values are input into the POS/MV and the CARIS HVFs. *Rainier* documentation did not include specific values for the Nav to Transducer offsets used in the TPE Offset section of the HVF. *Fairweather* personnel combined the RP (MRU) to transducer values with the MRU to GPS antenna values listed in the appropriate Vessel Offset Measurement Reports to obtain the Nav to Transducer offsets.

### **Addendum to section 3.0 – Static and Dynamic Draft**

*Rainier* personnel conducted dynamic draft determinations for launches 2801 and 2802 on March 12 and 30, 2009 respectively. The dynamic draft values obtained during those operations were used in the draft section of the CARIS HVFs. A shortened version of dynamic draft measurement testing was conducted on Launch 2801 on September 30, 2009 by Fairweather personnel for check purposes. The values observed were similar to the values provided by the *Rainier*. Testing documentation is included as additions to Appendix III.

### **Addendum to section 4.0 – Patch Tests**

The upgraded 7111 system on *Fairweather* was patch tested after installation of the 71-P top-side unit on Oct 6, 2009. There were no appreciable differences observed between the previous 8111 values, therefore the 7111 HVF uses the same values as the 8111 HVF. The patch test documentation is included as an addition in Appendix III.

Patch tests were conducted for the 2801 and 2802 launch configurations on the following dates: 2801 200kHz on Sept 28, 2009; 2801 400kHz on Sept 30, 2009; and 2802 200kHz and 400kHz on Oct 6, 2009. Values obtained were used in the associated HVFs and documents regarding the various patch tests are included as additions to Appendix III.

## Appendix I









---

### System Tracking

- Vessel Inventory
- Hardware Inventory
- Computer Inventory

## Hydrographic Vessel Inventory

Field Unit: FAIRWEATER  
 Effective Date: April 20, 2009  
 Updated Through: November 18, 2009

SURVEY VESSELS								
Vessel Name	FAIRWEATHER	Launch 1010	Launch 1018	Launch 2801	Launch 2802	Ambar 700	Skiff	FRB
Vessel Image								
Hull Number	S 220	1010	1018	2801	2802	2302	1706	2301
Call Letters	WTEB			WZ2574	WZ2575			
Manufacturer	Aerojet-General Shipyards	The Boat Yard, Inc.	The Boat Yard, Inc.	Jensen	Jensen	Marine Silverships, Inc	MonArk	Zodiak of North America
Year of Construction	1967	1973	1973	2007	2007	1998		2004
Type of Construction	Welded steel hull - ice strengthened	Aluminum hull	Aluminum Hull	Aluminum hull	Aluminum hull	RHIB	Aluminum Hull	RHIB
Length Overall	70.4 m (231 ft)	8.8 m (28ft 10in)	8.8 m (28ft 10in)	8.8 m (29 ft)	8.8 m (29 ft)	7.0 m (23 ft)	5.2 m (17 ft)	6.7 m (22 ft)
Beam	12.8 m (42 ft)	3.3 m (10ft 8in)	3.3 m (10ft 8in)	3.7 m (11ft 10in)	3.7 m (12 ft)	2.9 m (9ft 4in)	2.3 m (7ft 2in)	2.6 m (8ft 6in)
Draft	4.7 m (15ft 6in)	1.2 m (4 ft)	1.2 m (4 ft)	0.3 m	0.3 m	0.4 m (1ft 4in)	0.4 m (1ft 3in)	0.6 m (22 in)
Cruising Speed	12.5 knots	24 knots	24 knots			22 knots	20 knots	18 knots
Max Survey Speed	6 knots	6 knots	6 knots					
Date of Effective Full Vessel Static Offset Survey	Original Survey 9/23/2003 POS/MV Offsets Surveyed 2/2007 and 2/15/2009	2004	2004	31-Mar-08	31-Mar-08			
Organization which Conducted the Effective Full Offset Survey	Original Survey - Westlake Consultants POS/MV Spatial Surveys - NGS	NOAA Personnel (Wetzler, Sampadian, Froelich)	NOAA Personnel (Wetzler, Sampadian, Froelich)	NGS/GSD	NGS/GSD			
Date of Last Partial Survey or Offset Verification & Methods Used	n/a	3/20/2009 Steel Tape	8101: 3/20/2009 8125: 4/29/2009 Steel Tape	25-Apr-09	25-Apr-09			
Date of Last Static Draft Determination & Method Used	April-2009 Draft Marks	4/7/2009 Waterline to Benchmarks	4/7/2009 Waterline to Benchmarks	10-Apr-08	10-Apr-08			
Date of Last Settlement and Squat/Dynamic Draft Measurements & Method Used	2/23/2009 Post Processed Kinematic (Ellipsoidally referenced)	4/17/2009 Post Processed Kinematic (Ellipsoidally referenced)	4/16/2009 Post Processed Kinematic (Ellipsoidally referenced)	12-Mar-09, ERDDM	30-Mar-09, ERDDM			

## Hydrographic Hardware Inventory

Field Unit: FAIRWEATHER

Effective Date: 4/20/2009

Updated Through: 11/18/2009

### SONAR & SOUNDING EQUIPMENT

Equipment Type	Manufacturer	Model	Serial Number	Firmware and/or Software Version	Version Install Date	Location	Date of last Field Cal/Testing	Date of last Manufacturer Cal/Service	Bar Code	Comments
Processor	RESON	71-P (7111)	2009003	Dry: 8111-E209-6114 Wet: 8111-E101-AFAA	Oct 2009	S220	10/6/2009	installed on Oct - 2009		P/N 85101802
Processor	RESON	81-P (8111)	35652	Dry: 8111-E209-6114 Wet: 8111-E101-AFAA	Mar 2009	S220	N/A		CD0001065312	
Transducer	RESON	8111ER	unknown	N/A	Mar 2009	S220	4/28/2009	replaced transducer Mar-2009		
Processor	RESON	81-P (8160)	35385	Dry: 8160-2.09-7C6D Wet: 8160-1.00-E9E1	May-2004	S220	N/A		CD0001065313	
Transducer	RESON	8160	unknown	N/A	Apr-2004	S220	4/28/2009	installed in hull, 2004		
Processor	RESON	81-P	35737	Dry: 8101-2.09-E34D Wet: 8101-1.08-C215	Jul-2004	1010	N/A		CD0001065349	
Transducer	RESON	8101 ER	2701011	N/A	Jul-2004	1010	4/17/2009			
Processor	RESON	81-P	34497	Dry: 8101-2.09-E34D Wet: 8101-1.08-C215	Jul-2004	1018	N/A		CD0001065351	
Transducer	RESON	8101 ER	3102026	N/A	Jul-2004	1018	4/16/2009			
Processor	RESON	81-P	31562	Dry: 8125-2.10-A50F Wet: 8125-1.08-9E98	Unknown	1018	N/A		CD0000825308	
Transducer	RESON	8125	4400007	N/A	Unknown	1018	O119: 5/24/2009 P183: 6/27/2009	Unknown		on loan from RUDE
Towfish	Klein	5000	293	N/A		1018 / S220	preliminary testing 5/14/2009		CD0000825404	
Processor	Klein	Sonar Workstation	23-326-2WS	Sonar Pro 11.3		1018 / S220	preliminary testing 5/14/2010		CD0000825155	
Processor	Odom Hydrographic Systems	Echotrac CVM-A	26034	Version 4.01		2302 / 1706		new unit, May-2007	CD0001703210	ChartView Dongle (100.001.001.098)
Transducer (2)	Odom Hydrographic Systems	SMBB200-4A	TR5162/TR5159	N/A	N/A	2302 / 1706	N/A	N/A		Two 4 degree (large)
Transducer (2)	Odom Hydrographic Systems	SMBB200_9	TR5138/TR5139	N/A	N/A	2302 / 1706	N/A	N/A		Two 9 degree (small)
Divers Least Depth Gauge	PTC	MODIII	68337	N/A	N/A	S220	4/22/2009	4/2/2008	CD0001698256	
Lead Line	FA Personnel	Traditional	10_01_05	N/A	N/A	any	4/20/2009			
Lead Line	FA Personnel	Traditional	10_02_05	N/A	N/A	any	4/20/2009			
Lead Line	FA Personnel	Traditional	20_01_05	N/A	N/A	any	4/28/2009			
Lead Line	FA Personnel	Traditional	20_02_05	N/A	N/A	any	4/28/2009			
Lead Line	FA Personnel	Traditional	20_03_05	N/A	N/A	any	4/28/2009			
Lead Line	FA Personnel	Traditional	30_01_05	N/A	N/A	any	4/28/2009			
Lead Line	FA Personnel	V-100/Non-Traditional	10_05_09	N/A	N/A	any	4/28/2009			
Lead Line	FA Personnel	V-100/Non-Traditional	10_06_09	N/A	N/A	any				work in progress



POSITIONING & ATTITUDE EQUIPMENT										
Equipment Type	Manufacturer	Model	Serial Number	Firmware and/or Software Version	Version Install Date	Location	Date of last Field Cal/Testing	Date of last Manufacturer Cal/Service	Bar Code	Comments
POS/MV PCS	Applanix	320 V.4	2411	HW2.9-7, SW03.42 POS Cntrlr v. 4.0.2.0	Jun-2008	S220 IP:129.100.1.231	4/27/2009		CD0001697462	Auth. No. 811025-00534537
POS/MV IMU	Applanix	LN200	292	N/A	Apr-2004	S220			CD0001696450	
POS/MV Primary GPS Receiver	Applanix	BD950	4611A66708	v.00211	Feb-2007	S220				
POS/MV Secondary GPS Receiver	Applanix	BD950	4602A62806	v.00211	Feb-2007	S220				
POS/MV Port Antenna	Applanix	OEM2 3151R	60103854	HW1	Feb-2007	S220				P/N 39105-00 DC 4602
POS/MV Stbd Antenna	Applanix	OEM2 3151R	60125191	HW1	Feb-2007	S220				P/N 39105-00 DC 4602
DGPS Receiver	CSI Wireless	MBX-3S	0324-11969-0002	N/A	Jul-2004	S220			CD0001065375	
DGPS Antenna	CSI Wireless	MGL3	9824-1779-0002	N/A	Apr-2004	S220				
DGPS Antenna	Furno	GPA-019S	21299	N/A		S220				
POS/MV PCS	Applanix	320 V.4	2564	HW 2.6-7, SW 03.42 POS Cntrlr v. 3.4.0.0	Jun-2008	1010 IP:129.100.1.231	4/15/2009, 8/23/2009	1/15/2008	CD0001601275	
POS/MV IMU	Applanix	LN200	294	N/A	Jul-2003	1010			CD0001696449	
POS/MV Primary GPS Receiver	Applanix	BD950	4624A70264	v.00211	Mar-2007	1010				
POS/MV Secondary GPS Receiver	Applanix	BD950	4624A68956	v.00211	Mar-2007	1010				
POS/MV Port Antenna	Applanix	OEM2 3151R	60162863	HW1	Mar-2007	1010				Broken on 8/22/09 while removing
POS/MV Stbd Antenna	Applanix	OEM2 3151R	60145247	HW1	Mar-2007	spare				removed from 1010 on 8/22/09
POS/MV Port Antenna	Trimble	39105-00	60268090	N/A	Aug-2009	1010				From new batch of 20 spares to be purchased by Larry Lowen- sent by Olivia
POS/MV Stbd Antenna	Trimble	39105-00	60078644	N/A	Aug-2009	1010				From Rude- sent by Olivia
DGPS Receiver	CSI Wireless	MBX-3S	0331-12579-0008	N/A	Jul-2004	1010			CD0001065289	
DGPS Antenna	CSI Wireless	MGL3	0331-12579-0009	N/A	Jul-2004	1010				
POS/MV PCS	Applanix	320 V.4	2560	HW 2.6-7, SW 03.42 POS Cntrlr v. 3.4.0.0	Jun-2008	1018 IP:129.100.1.231	4/15/2009	1/15/2008	CD0001601274	
POS/MV IMU	Applanix	LN200	007	N/A	Feb-2007	1018				
POS/MV Primary GPS Receiver	Applanix	BD950	4624A70243	v.00211	Feb-2007	1018				
POS/MV Secondary GPS Receiver	Applanix	BD950	4624A70263	v.00211	Feb-2007	1018				
POS/MV Port Antenna	Trimble	OEM2 3151R	60145158	N/A	Feb-2007	1018			39105-00 DC 4618	
POS/MV Stbd Antenna	Trimble	OEM2 3151R	60130644	N/A	Feb-2007	1018			39105-00 DC 4604	
DGPS Receiver	CSI Wireless	MBX-3S	0328-12362-0001	N/A	Jul-2004	1018			10652291	
DGPS Antenna	CSI Wireless	MGL3	0328-12352-0002	N/A	Jul-2004	1018				
Trimble Backpack 1	Trimble	Pathfinder Pro XRS	0224078543	Firmware v1.96 RevA	Mar-2008	S220			CD0001269835	
Trimble Backpack 1: Antenna	Trimble	33580-50	0220341062	N/A	N/A	S220			no Bar Code	
Trimble Backpack 2	Trimble	Pathfinder Pro XRS	0224090101	Firmware v1.96 RevA	Mar-2008	S220			CD0001269836	
Trimble Backpack 2: Antenna	Trimble	33580-50	0220321059	N/A	N/A	S220			no Bar Code	
Handheld data collector	Trimble	TSCe	37318	N/A	N/A	S220			no Bar Code	PN 45268-50
Antenna cable	Trimble					S220				P/N22628
Camcorder Batteries	Trimble					S220				P/N17466
NMEA/RTCM cable	Trimble					S220				P/N30232-00
data/power cable	Trimble					S220				P/N30231-00
dual battery cable	Trimble					S220				P/N24333
GPS Pathfinder field device cable	Trimble					S220				P/N45052
Laser	Laser Tech Inc.	Impulse Laser Rangefinder	i09290	N/A	N/A	S220			CD0001269812	
Laser	Laser Tech Inc.	TruPulse 200 Laser Rangefinder	001481	N/A	N/A	S220				no Bar Code
Laser	Laser Tech Inc.	TruPulse 200 Laser Rangefinder	000676	N/A	N/A	S220				no Bar Code

**SOUND SPEED MEASUREMENT EQUIPMENT**

Equipment Type	Brooke Ocean Technology Inc.	Model	Serial Number	Firmware and/or Software Version	Version Install Date	Location	Date of last Field Cal/Testing	Date of last Manufacturer Cal/Service	Bar Code	Comments
Moving Vessel Profiler winch	Brooke Ocean Technology Inc.	MVP-200-5	10328			S220	N/A	Apr-2009		Visit by BOT tech Darrell Groom
Moving Vessel Profiler fish	Brooke Ocean Technology Inc.	MVP-FFF-SS-32-1	10478			S220	N/A	Apr-2009		Visit by BOT tech Darrell Groom, primary fish
Moving Vessel Profiler fish	Brooke Ocean Technology Inc.	MVP-FFF-SS-32-1	10329			S220	N/A	Apr-2009		Visit by BOT tech Darrell Groom, spare fish
Moving Vessel Profiler sensor	Applied Micro Systems Ltd.	AML Smart SV +P	4986			S220	DQAs weekly	10/2/2009		installed in primary fish
Moving Vessel Profiler sensor	Applied Micro Systems	AML Smart SV +P	5229			S220	DQAs weekly if in service			Returned to AML for service, April 2009
Moving Vessel Profiler sensor	Applied Micro Systems Ltd.	AML Smart SV +P	5466			S220	DQAs weekly if in service	10/30/2009		Purchased 2008, installed in spare fish
SEACAT Profiler	Sea-Bird	SBE 19plus	19P36026-4585	1.4D		S220	DQAs weekly	12/24/2008		CON file: 4585.con
SEACAT Profiler	Sea-Bird	SBE 19plus	19P36026-4616	1.4D		1010 or 1018	DQAs weekly	12/30/2008		CON file: 4616.con
SEACAT Profiler	Sea-Bird	SBE 19plus	19P36026-4617	1.4D		1010 or 1018	DQAs weekly	12/20/2008		CON file: 4617.con
SEACAT Profiler	Sea-Bird	SBE 19plus V2	19P50959-6121	2.1		1010 or 1018	DQAs weekly	8/28/2009		CON file: 6121.con
SEACAT Profiler	Sea-Bird	SBE 19plus V2	19P50959-6122	2.1		1010 or 1018	DQAs weekly	8/29/2009		CON file: 6122.con
Real Time Sound Speed Profiler	RESON	SVP 70	4008077			S220	DQAs weekly	1/4/2009		
Real Time Sound Speed Profiler	Odom Hydrographic Systems	Digibar Pro/ DB 1200	98207	SW 1.11		1018	DQAs weekly	4/16/2009		Previous S/N listed: 98013-041609

**TIDES & LEVELING EQUIPMENT**

Equipment Type	Manufacturer	Model	Serial Number	Firmware and/or Software Version	Version Install Date	Location	Date of last Field Cal/Testing	Date of last Manufacturer Cal/Service	Bar Code	Comments
Level	Carl Zeiss	N12 333	100056	N/A	N/A	S220	Mar-2009	Mar-2008		
Level	Carl Zeiss	N12 333	103267	N/A	N/A	S220	Mar-2009	Mar-2008		
Level	Leica	NA2 100	5332739	N/A	N/A	S220				Spare
Level	Lecia	NA2 100	5332747	N/A	N/A	S220				Spare

**HORIZONTAL AND VERTICAL CONTROL EQUIPMENT**

Equipment Type	Manufacturer	Model	Serial Number	Firmware and/or Software Version	Version Install Date	Location	Date of last Field Cal/Testing	Date of last Manufacturer Cal/Service	Bar Code	Comments
GPS Reciever	Trimble	NetR5	4910K61066	4.03	Apr-2009	S220	Apr-2009	obtained Apr-2009	CD0001526972	HorCon
GPS Antenna	Trimble	Zephyr Geodetic 2	30767996			S220	Apr-2009	obtained Apr-2009	no Bar Code	HorCon
GPS Reciever	Trimble	NetR5	4910K61054	4.03	Apr-2009	S220	Apr-2009	obtained Apr-2009	CD0001526973	HorCon
GPS Antenna	Trimble	Zephyr Geodetic 2	30767941			S220	Apr-2009	obtained Apr-2009	no Bar Code	HorCon
GPS Receiver	Ashtech	Z-Xtreme	ZE1200339016	ZE21	Mar-2008	S220	Apr-2009	obtained Apr-2004	CD0001062363	HorCon
GPS Antenna	Ashtech	Geodetic 4	8365			S220	Apr-2009	obtained Apr-2004	No Barcode	HorCon
UHF Radio	FreeWave	HTP-900RE	884-8978	2.17	Mar-2009	S220		obtained Mar-2009	CD0001526970	
UHF Radio	FreeWave	HTP-900RE	884-9190	2.17	Mar-2009	S220		obtained Mar-2009	CD0001526971	
UHF Radio	FreeWave	HTP-900RE	884-9511	2.17	May-2009	S220		obtained May-2009	no Bar Code	
UHF Radio	FreeWave	HTP-900RE	884-9301	2.17	May-2009	S220		obtained May-2009	no Bar Code	
UHF Antenna	PCTEL	MAX9053				S220		obtained May-2009	no Bar Code	
UHF Antenna	PCTEL	MAX9053				S220		obtained May-2009	no Bar Code	
UHF Antenna	PCTEL	MAX9053				S220		obtained May-2009	no Bar Code	
UHF Antenna	PCTEL	MAX9053				S220		obtained May-2009	no Bar Code	
Solar Charger	PWM	EPRC5				S220		obtained May-2009	no Bar Code	
Solar Charger	PWM	EPRC5				S220		obtained May-2009	no Bar Code	
Solar Charger	PWM	EPRC5				S220		obtained May-2009	no Bar Code	
Solar Panel	Uni-Solar	FLX-32	USF-32-14639	N/A	N/A	S220			no Bar Code	
Solar Panel	Uni-Solar	FLX-32	USF-32-14634	N/A	N/A	S220			no Bar Code	
Solar Panel	Uni-Solar	FLX-32	USF-32-14633	N/A	N/A	S220			no Bar Code	
Solar Panel	Uni-Solar	FLX-32	USF-32-14529	N/A	N/A	S220			no Bar Code	
Solar Panel	Uni-Solar	FLX-32	USF-32-14631	N/A	N/A	S220			no Bar Code	
Solar Panel	Uni-Solar	FLX-32	USF-32-14625	N/A	N/A	S220			no Bar Code	
Solar Panel	Uni-Solar	FLX-32	USF-32-14645	N/A	N/A	S220			no Bar Code	
Solar Panel	Uni-Solar	MBC-525	525-011590	N/A	N/A	S220			CD000684513	
Solar Panel	Uni-Solar	MBC-526	525-011093	N/A	N/A	S220			CD000684507	
Solar Panel	Uni-Solar	MBC-527	525-011589	N/A	N/A	S220			CD000684510	
Solar Panel	Uni-Solar	MBC-528	525-011607	N/A	N/A	S220			CD000684512	
Solar Panel	Uni-Solar	MBC-529	525-011587	N/A	N/A	S220			CD000684511	
Solar Panel	GE Energy	GEPV-030-MNA	C30G200506210062	N/A	N/A	S221			no Bar Code	
Solar Panel	GE Energy	GEPV-030-MNA	C30G200506210063	N/A	N/A	S222			no Bar Code	
Solar Panel	GE Energy	GEPV-030-MNA	C30G200506210075	N/A	N/A	S223			no Bar Code	
Solar Panel	GE Energy	GEPV-030-MNA	C30G200506210076	N/A	N/A	S222			no Bar Code	
Solutions Dongles	Ashtech	600586 (A)	KEB2083	N/A	N/A	S220			no Bar Code	
Solutions Dongles	Ashtech	600586 (A)	KEB2077	N/A	N/A	S220			no Bar Code	

**ADDITIONAL POSITIONING EQUIPMENT**

Equipment Type	Manufacturer	Model	Serial Number	Firmware and/or Software Version	Version Install Date	Location	Date of last Field Cal/Testing	Date of last Manufacturer Cal/Service	Bar Code	Comments
GPS RTK Receiver	Trimble	DSM-232	225111661	3.57	Mar-2008	S220			CD0001697439	RTK capable
GPS Receiver	Trimble	DSM-232RS	225111655	3.57	Mar-2008	S220			CDCD0001697422	not upgradable
DGPS Antenna	Trimble	33580-00	220395038	N/A	N/A	S220			no Bar Code	
GPS Antenna	Trimble	Zephyr Geodetic Antenna	30325441	N/A	N/A	S220			no Bar Code	
GPS Antenna	Trimble	SPS MSK	5876	N/A	N/A	S220			no Bar Code	
GPS RTK Receiver	Trimble	MS 750	220339262						CD 0001478898	RTK capable
GPS Antenna	Trimble	Trimble Micro Centered L1/L2	220298707	N/A	N/A	S220			no Bar Code	NOAA Launch Barcode A2008
Position Data Link High Powered Base Unit	Pacific Crest	PDL 4135	0424 0171	2.40	Apr-2004	S220	5/3/2007	obtained Apr-2004	CD0001269910	
Position Data Link Rover	Pacific Crest	PDL 4100	04240154	2.4	Apr-2004	S220	5/3/2007	obtained Apr-2004	CD0001269896	
Position Data Link Rover	Pacific Crest	PDL 4100	03473047	2.32	Apr-2004	S220	5/3/2007	obtained Apr-2004	CD0001269912	
Position Data Link Rover	Pacific Crest	PDL 4100	04240155	2.4	Apr-2004	S220	5/3/2007	obtained Apr-2004	CD0001269911	
Position Data Link Rover	Pacific Crest	PDL 4101	07095939			S220			no Bar Code	

**Additional Hardware from Rainier used after Sept 27, 2009**

<b>SONAR &amp; SOUNDING EQUIPMENT</b>										
<b>Equipment Type</b>	<b>Manufacturer</b>	<b>Model</b>	<b>Serial Number</b>	<b>Firmware and/or Software Version</b>	<b>Version Install Date</b>	<b>Location</b>	<b>Date of last Field Cal/Testing</b>	<b>Date of last Manufacturer Cal/Service</b>	<b>Bar Code</b>	<b>Comments</b>
Processor/ TPU	RESON		2708010			2801			CD0001527020	
Processor/ LCU	RESON		1515002			2801				
7125 Receiver	RESON	EM7200	5006315			2801				
400kHz Projector	RESON	TC2160	5006098			2801				
200kHz Projector	RESON	TC2163	4605049			2801				
Processor/ TPU	RESON		2708006			2802			CD0001615441	
Processor/ LCU	RESON		1515003			2802				
7125 Receiver	RESON	EM7200	2208058	N/A		2802				
400kHz Projector	RESON	TC2160	1908193			2802				NOAA CD: P004305
200kHz Projector	RESON	TC2163	5006388			2802				
<b>POSITIONING &amp; ATTITUDE EQUIPMENT</b>										
<b>Equipment Type</b>	<b>Manufacturer</b>	<b>Model</b>	<b>Serial Number</b>	<b>Firmware and/or Software Version</b>	<b>Version Install Date</b>	<b>Location</b>	<b>Date of last Field Cal/Testing</b>	<b>Date of last Manufacturer Cal/Service</b>	<b>Bar Code</b>	<b>Comments</b>
POS/MV PCS	Applanix	POS/MV 320 V4	2893		Oct-2007	2801				
POS/MV IMU	Applanix	POS/MV 320 V4	693	N/A	Sep-2007	2801				
POS/MV Primary GPS Receiver	Applanix	BD950	4733A85875	v. 00227		2801				
POS/MV Secondary GPS Receiver	Applanix	BD950	4733A85880	v. 00227		2801				
POS/MV Port Antenna	Trimble	Zephyr	60216913	N/A		2801				
POS/MV Stbd Antenna	Trimble	Zephyr	60216723	N/A		2801				
DGPS Receiver	Furuno	GR-80	3506-8414	N/A		2801				
DGPS Antenna	Furuno	GR-8	1-1380	N/A		2801				
POS/MV PCS	Applanix	POS/MV 320 V4	2896		4/10/2007	2802	5/5/2007			
POS/MV IMU	Applanix	POS/MV 320 V4	694	N/A	N/A	2802	Model LN 200			
POS/MV Primary GPS Receiver	Applanix	BD 950	4733A8561	v. 00227		2802				
POS/MV Secondary GPS Receiver	Applanix	BD 950	4732A85572	v. 00227		2802				
POS/MV Port Antenna	Trimble	Zephyr	60205688	N/A		2802				
POS/MV Stbd Antenna	Trimbe	Zephyr	60201133	N/A		2802				
DGPS Receiver	Furuno	GR-80	3506-8385	N/A		2802				
DGPS Antenna	Furuno	GR-8	1-1486	N/A		2802				
<b>SOUND SPEED MEASUREMENT EQUIPMENT</b>										
<b>Equipment Type</b>	<b>Brooke Ocean Technology Inc.</b>	<b>Model</b>	<b>Serial Number</b>	<b>Firmware and/or Software Version</b>	<b>Version Install Date</b>	<b>Location</b>	<b>Date of last Field Cal/Testing</b>	<b>Date of last Manufacturer Cal/Service</b>	<b>Bar Code</b>	<b>Comments</b>
Real Time Sound Speed Profiler	RESON	SVP 71 / EM7213	2107032			2801				
Real Time Sound Speed Profiler	RESON	SVP 71 / EM7214	1306040			2802				NOAA CD: P004304

**FAIRWEATHER Computers**

Machine Name	Location	Make/Model	Operating System	Date Purchased	Date of Last Rebuild	Processor Speed	RAM (original)	RAM (checked March 2006)	Number of Video Outputs	Video RAM	Service Tag	Barcode	Comments
FA_Proc_1	Plot Room	DELL Precision 490	XP Pro 2002 SP3	Nov-07		2.66 GHz	3GB		2	256 MB	9MP1PD1	CD0001615385	New DELL desktop installed week of 12/4/07
FA_Proc_2	Plot Room	DELL Precision 490	XP Pro 2002 SP3	Nov-07		2.66 GHz	3GB		2	256 MB	4NP1PD1	CD0001615382	New DELL desktop installed week of 12/4/07
FA_Proc_3	Plot Room	DELL Precision 490	XP Pro 2002 SP3	Nov-07		2.66 GHz	3GB		2	256 MB	6MP1PD1	CD0001615383	New DELL desktop installed week of 12/4/07
FA_Proc_4	Plot Room	DELL Precision 490	XP Pro 2002 SP3	Nov-07		2.66 GHz	3GB		2	256 MB	2NP1PD1	CD0001615380	New DELL desktop installed week of 12/4/07
FA_Proc_5	Plot Room	DELL Precision 490	XP Pro 2002 SP3	Nov-07		2.66 GHz	3GB		2	256 MB	3MP1PD1	CD0001615381	New DELL desktop installed week of 12/4/07
FA_Proc_6	Plot Room	Dell Precision T3400	XP Pro 2002 SP3	Apr-08		3.0GHz	3GB		2	512MB	1JKCZF1	CD0001615471	New DELL desktop installed week of 04/06/08
FA_Proc_7*	Plot Room	DELL Precision 490	XP Pro 2002 SP3	Nov-07		2.66 GHz	3GB		2	256 MB	8MP1PD1	CD0001615384	New DELL desktop installed week of 12/4/07
FA_Proc_8	Plot Room	Dell Precision T3400	XP Pro 2002 SP3	Apr-08		3.0GHz	3GB		2	512MB	5JKCZF1	CD0001615467	New DELL desktop installed week of 04/14/08
FA_Proc_9	Plot Room	Dell Precision T3400	XP Pro 2002 SP3	Apr-08		3.0GHz	3GB		2	512MB	3JKCZF1	CD0001615472	New DELL desktop installed week of 04/06/08
FA_Proc_10	DP-2	Dell Precision T3400	XP Pro 2002 SP3	Apr-08		3.0GHz	3GB		2	512MB	JHKCZF1	CD0001615468	New DELL desktop installed week of 04/06/08
FA_CST	Field Office	Dell Precision T3400	XP Pro 2002 SP3	Apr-08		3.0GHz	3GB		2	512MB	4JKCZF1	CD0001615469	New DELL desktop installed week of 04/06/08
FA_FOO	Field Office	Dell Precision T3400	XP Pro 2002 SP3	Apr-08		3.0GHz	3GB		2	512MB	DHKCZF1	CD0001615470	New DELL desktop installed week of 04/06/08
FA_O-LAB*	O-LAB	Dell Precision 360	XP Pro 2002 SP3			3.0GHz	3.5GB		2	128MB	GBBG451	CD0001741480	
Toughbook 1	Laptop	Panasonic CF-18	XP Pro 2002 SP2	~ March 2004	~ July 2006	1.1 GHz	2.5 GB	N/A	1	64 MB	4HKSA59499	CD0001269860	*rebuilt after crash July 2006
Toughbook 2	Laptop	Panasonic CF-18	XP Pro 2002 SP2	~ March 2004	~ September 2005	1.1 GHz	2.5 GB	N/A	1	64 MB	4HKSA59560	CD0001269858	
Toughtab 1	Laptop	Panasonic CF-18	XP Pro 2002 SP2	~ March 2004	~ September 2005	1.1 GHz	2.5 GB	N/A	1	64 MB	4GKSA55049	CD0001269859	
Toughbook 3	Laptop	Panasonic CF-29	XP Pro 2002 SP2	March 2006	N/A	1.6 GHz	2.5 GB	N/A	1	128 MB	6AKSB06863	CD0001698251	
Toughbook 4	Laptop	Panasonic CF-30	XP Pro 2002 SP3	March 2009		1.7GHz	1 Gb		0	384 MB	8HKSB80630	CD0001447100	out for service
Toughbook 6	Laptop	Panasonic CF-30	XP Pro 2002 SP3	March 2009		1.7GHz	1 Gb		0	384 MB			out for service
Toughbook 5	Laptop	Panasonic CF-19	XP Pro 2002 SP3	March 2009		1.1GHz	1 Gb		1	384 MB	9AKSB43281	CD0001696424	
1010_ACQ	Launch 1010	ICI	XP Pro 2002 SP2	Mar-08		2.66GHz	3GB		3	128MB		CD0001615466	
1018_ACQ	Launch 1018	ICI	XP Pro 2002 SP2	Mar-08		2.66GHz	3GB		3	128MB		CD0001615463	
S220_ACQ	Plot Room	Dell Precision T3400	XP Pro 2002 SP2	Mar-08		3.0GHz	3GB		3	512MB	CSH8NF1	CD0001615444	
FA_MVP200	Plot Room	MVP-C1-2001	2000 SP4	~ March 2004	~ September 2005	2.4 GHz	230 MB	230 MB	1	64 MB	SN: 10330	CD0001269854	

## Appendix II

---

### Equipment Specifications

#### 1. Sonar Systems

- a. RESON
  - i. 8101 Product Specs
  - ii. 8111 Product Specs
    - 1. 7111 Product Specs
  - iii. 8160 Product Specs
  - iv. 8125 Product Specs
  - v. 7125 Product Specs
- b. VBES
  - i. Odom Echotrac CVM
  - ii. SMBB200-9 Transducer Information
  - iii. SMSW200-4a Transducer Information
- c. SSS
  - i. Klein 5000

#### 2. Positioning

- a. POS MV
  - i. v320
- b. DGPS
  - i. MBX-3S
  - ii. SF-2050

#### 3. Shoreline

- a. Trimble
  - i. Accuracy
  - ii. Specs
  - iii. TSCe
- b. Lasers
  - i. TruPulse 200
  - ii. Impulse 200 LR

#### 4. SV

- a. MVP
  - i. MVP 200
- b. SBE
  - i. SBE 45
  - ii. SVP 70
  - iii. Specs-19p-4585
  - iv. Specs-19p-4616
  - v. Specs-19p-4617
  - vi. Specs-19pV2-6121
  - vii. Specs-19pV2-6122

#### 5. Control

- a. Leveling
  - i. Leica NA2 level
  - ii. Zeiss NI2 level

- b. HorCon
  - i. PDL
  - ii. Z-Xtreme Ashtech GPS

**6. Total Stations**

- a. Nikon DTM310
- b. Sokkia SET5F

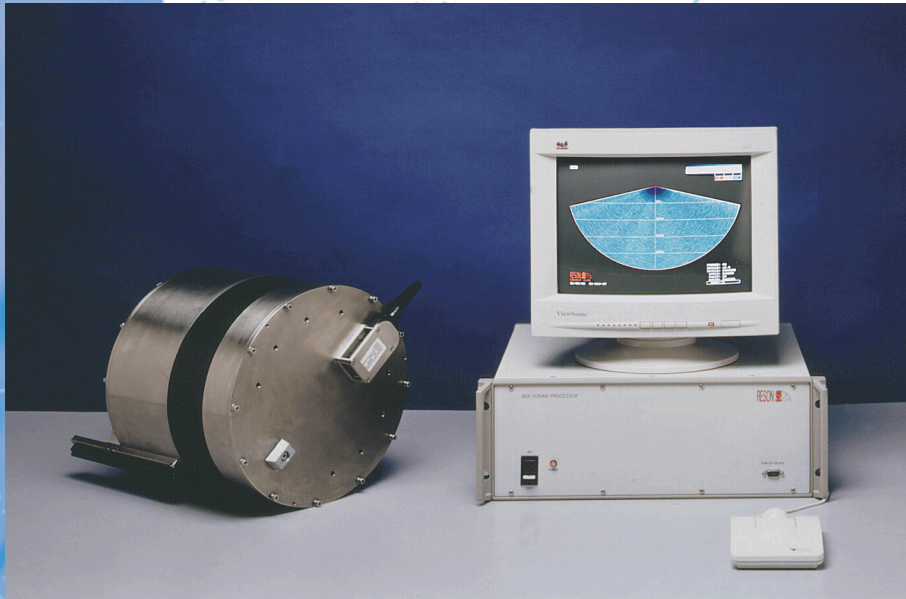




# SeaBat 8101

## PRODUCT SPECIFICATION

### 240kHz MULTIBEAM ECHO SOUNDER



- ! Phase and Amplitude Bottom Detection
- ! 150° Wide Swath Coverage
- ! 240 kHz Frequency
- ! Up to 500m Range Capability
- ! Portable Configuration
- ! Meets USACE Class 1 Standards
- ! Meets IHO Standards

The SeaBat 8101 Multibeam Echo Sounder measures discrete depths, enabling complex underwater features to be mapped with precision. Dense coverage is achieved utilizing up to 3,000 soundings per second for a swath that can be over 500 meters wide, even as the survey vessel travels at speeds of over 18 knots.

With high accuracy and a measurement rate up to 30 profiles per second, the SeaBat 8101 enables surveys to be completed faster and in greater detail than previously realized. The SeaBat is an integral part of the new, integrated bathymetry surveying systems.

The SeaBat transducer is available pressurized for depths from 100 to over 3,000 meters. Small and lightweight, it can be mounted on small un-vehicles (ROV, AUV or towed) and taken to where accurate measure required.



RESON A/S  
Denmark  
Tel: +45 47 38 00 22  
Fax: +45 47 38 00 66  
E-mail: [reson@reson.dk](mailto:reson@reson.dk)

RESON INC.  
USA  
Tel: +1 805 964-6260  
Fax: +1 805 964-7537  
sales@reson.com

RESON OFFSHORE LTD.  
United Kingdom  
Tel: +44 1224 727 427  
Fax: +44 1224 727 428  
sales@reson.infotrade.co.uk

<http://www.reson.com>



SeaBat 8101 Built-In Test Environment ("BITE") Screen

## SYSTEM SPECIFICATIONS

- Operating Frequency:** 240kHz  
**Range Scales:** 5, 10, 15, 20, 25, 35, 50, 75, 100, 125, 150, 175, 200, 250, 300, 350, 400, 450, 500m.  
**Range Resolution:** 1.25 cm  
**Number of Beams:** 101  
**Horizontal Beamwidth:** 1.5°  
**Horizontal Coverage:** 150°  
**Vertical Beamwidth:** 1.5°  
**Update Rate:** Range-variable up to 30 times per second

## SONAR HEAD SPECIFICATIONS

- Power Requirement:** 24VDC, 2 Amps max. (Power available from surface processor.)  
**Uplink:** Digital, 76.8 Mbaud  
**Down Link Control:** RS-232 or RS-422, 19,200 baud  
**Operating Depth:** 100 meters (300m, 1500m, 3000m & 6000m avbl.)  
**Dimensions:** 266x320mm W/Diam (does not include projector)  
**Temperature:** Operating: -5° to +40°C Storage: -30° to +55°C  
**Weight (aluminum):** Dry: 26.8 kg (59 lbs) Wet: 4.8 kg (10.6 lbs)  
**Weight (titanium):** Dry: 40 kg (88 lbs) Wet: 18 kg (39.6 lbs)

## DISPLAY SPECIFICATIONS

- Screen Size:** 14 inch Diagonal  
**Input:** SVGA (800x600, 72 Hz)  
**Display:** High Resolution Color  
**Power Consumption:** 62 W

## PROCESSOR SPECIFICATIONS

- Power Requirements:** 115/230VAC, 50/60Hz, 100W max.  
**Data Output:** Selectable, 300-155.2 Kbaud or Ethernet 10 base T or 10 base 2  
**Video Output:** SVGA (800x600, 72 Hz) or NTSC or PAL video.  
**Graphics Colors:** 256 colors (8-bit)  
**Display Mode:** Sector Format  
**Display Arc:** 150°  
**Input Device:** 3-Button Trackball  
**Dimensions:** 19" rack, 4U high (266x483x434mm HWD)  
**Temperature:** Operating: 0° to +40°C Storage: -30° to +55°C  
**Weight:** 20 kg (44 lbs)



SeaBat 8101 Head with Optional Fairings

## OPTIONS

- Option 033:** Side Scan Upgrade  
**Option 034:** Mounting Plate Assembly  
**Option 035:** Fairings (pictured above)  
**Option 036:** Spares Kit  
**Option 037:** Titanium Housing  
**Option 038:** 210° Swath  
**Option 040:** Extended-Range Projector  
**Option 049:** Increase Transducer Depth Rating



# SeaBat 8111

## PRODUCT SPECIFICATION

### MULTIBEAM ECHOSOUNDER



- Phase and amplitude bottom detection
- 100 kHz frequency
- 150° swath coverage
- Real-time quality control
- Sidescan upgradeable
- Modular and portable
- Pitch stabilization

The SeaBat 8111 is a modular multibeam echosounder system operating at 100 kHz. When installed on a vessel, it produces high-density, high-accuracy soundings on the seafloor over a 150° swath. Major system components include a transducer array, a transceiver unit, and a processor unit.

The SeaBat 8111 transducer array is comprised of a cylindrical receive array and a linear transmitter array, mounted together on a support cradle that provides mounting points to the vessel. Lightweight and portable, the array can be installed temporarily over the side of a vessel of opportunity—a first for a system in this frequency range.

The SeaBat 8111 transceiver features plug-in cards for easy maintenance and is controlled from the sonar processor.

The Seabat 8111 processor is compatible with other SeaBat sonar heads, can be updated in minutes to accommodate future requirements, and features a user-friendly point-and-click interface.



RESON A/S  
Denmark  
Ph: + 45 47 38 00 22  
Fax: + 45 47 38 00 66  
email: reson@reson.dk

RESON Inc.  
USA  
Ph: + 1 805 964 6260  
Fax: + 1 805 964 7537  
email: sales@reson.com

RESON Offshore Ltd.  
UK  
Ph: + 44 1224 709 900  
Fax: + 44 1224 709 910  
email: sales@reson.co.uk

RESON GmbH  
Germany  
Ph: + 49 431 720 7180  
Fax: +49 431 720 7181  
email: reson@reson-gmbh.de

RESON SA (PTY) LTD  
South Africa  
Ph: + 27 21 786 3420  
Fax: +27 21 786 3462  
email: reson@reson.co.za

RESON-Telenav  
Singapore  
Ph: + 65 6 872 0863  
Fax: +65 6 872 1334  
email: telenav@mbox2.singnet.com.sg

# SeaBat 811 SYSTEM SPECIFICATIONS

## SYSTEM PERFORMANCE

<b>Frequency:</b>	100 kHz
<b>Range Resolution:</b>	3.7 cm
<b>Swath Coverage:</b>	150°
<b>Range:</b>	3m to 1200m (with Option 040)
<b>Number of Beams:</b>	101
<b>Along-Track Beamwidth:</b>	1.5° 3.0° 4.5° 6.0°*
<b>Across-Track Beamwidth:</b>	1.5°
<b>Stabilization:</b>	Pitch stabilization within +/-15°
<b>Projector Beam Control:</b>	External motion sensor required
<b>Accuracy:</b>	IHO Compliant
<b>Operational Speed:</b>	Up to 20 knots
<b>Max. Update Rate:</b>	35 Hz
<b>Transducer Pressure Rating:</b>	100m

\*operator selectable

## INTERFACE

<b>System Supply:</b>	90 to 260VAC, 50/60 Hz, 200W max.
<b>Video Display:</b>	SVGA, 800 x 600, 72 Hz
<b>System Control:</b>	Trackball or from Ethernet
<b>Data Output:</b>	10 MB Ethernet or serial RS232C
<b>Data Uplink:</b>	High-speed digital coax with fiber-optic option
<b>Temperature:</b>	Operating: 0° to +40° C Storage: -30° to +55° C

## RELATED PRODUCTS

- Option 040 Extended range capabilities
- Option 033 Sidescan upgrade
- Option 051 24DC power supply for SeaBat 81-P Processor

## MECHANICAL INTERFACE

### Dimensions (in mm):

#### Transducer Array:

**Hydrophone:** 636 x 118 (Dia./Length)

**Projector:** 113 x 650 (Dia./Length)

**Processor:** 177 x 483 x 417

**Transceiver:** 267 x 483 x 489

### Weight:

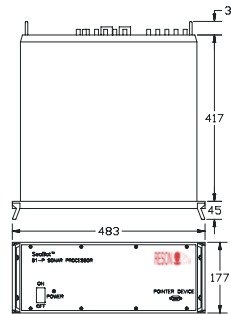
**Transducer Array:** 72 kg (dry) / 59 kg (wet)  
with cables

**Processor:** 20 kg

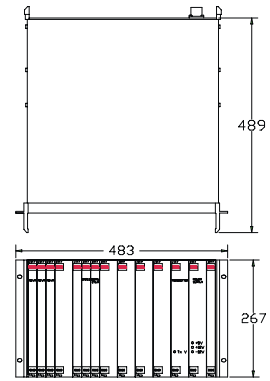
**Transceiver:** 13.6 kg

### Cable Length:

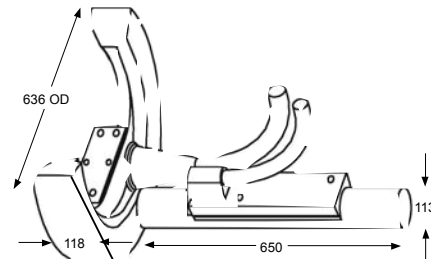
15m



Processor



Transceiver



Hydrophone

Projector

Transducer Array

## SEAFLOOR COVERAGE

(with Extended Range option)

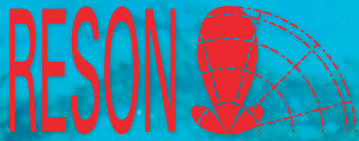
Bottom Depth (meters)	Swath Width (meters)
5 to 150	Up to 1110 (7.4 x water depth)
300	960 (3.2 x water depth)
450	810 (1.8 x water depth)
600	600 (1.0 x water depth)
750	450 (0.6 x water depth)
900	360 (0.4 x water depth)



Version: B006 030205

©1999 RESON Inc.

Due to our policy of continuous product improvement, RESON reserves the right change specifications without notice.



# SeaBat 7111

Multibeam Echosounder System



- **Portable System**
- **Suitable for Vessel Over-the-Side, Bow or Hull Mounting**
- **100kHz Frequency**
- **101, 201 Equi-Angle / 301 Equi-Distant Focused Beams**
- **150° Swath Coverage**
- **Bathymetry & Imagery from 3m to 1000m**

## SeaBat 7111

The SeaBat 7111 produces bathymetry data suitable for the generation of high resolution hydrographic charts exceeding international standards in water depths from 3 to 1000m. Operating at 100kHz, the system forms 101, 201 high-density, equi-angle or 301 equi-distant beams to cover a total receive sector of 150°.

The SeaBat 7111 transducer array is comprised of a cylindrical receive array and a linear transmitter array, mounted together on a support cradle that provides mounting points to the vessel. Lightweight and portable, the array can be installed temporarily over the side of a vessel of opportunity - a first for a system in this frequency range.

The SeaBat 7111 is controlled by the 7-P, a high performance Sonar Processor that manages data flow and signal processing using a state-of-the-art FPGA architecture. The 7-P provides a Windows®-based GUI user interface, allowing system configuration, control, data output, storage and built-in test environment (BITE) displays to assist the operator.

Equi-distant or equi-angular beam spacing across the entire swath is selectable by the operator to provide uniform sounding density and maximize usable outer swath. Data outputs include bathymetry, sidescan, snippets & beamformed water column data.







# SeaBat 8160

## PRODUCT SPECIFICATION

### MULTIBEAM ECHOSOUNDER SYSTEM



- **Swath coverage greater than 4x water depth**
- **Operational depth: 10m to 3000m**
- **50 kHz frequency**
- **126 beams**
- **Hull-mount or portable**
- **Meets IHO accuracy**
- **Sidescan upgradable**

The SeaBat 8160 is a new addition to the 8100 series of multibeam echosounders. Operating at 50 kHz, the system ensonifies the whole swath in a single ping, generating 126 simultaneous high-resolution receive beams.

The SeaBat 8160 transducer array is comprised of a linear receive and transmit array mounted together on a support base. The T-shaped array geometry provides the basis for a compact, high-resolution sonar which is easily installed for portable or hull mounts—a first for a high-resolution system in this frequency range.

The system features a pitch-stabilized transmitter and an active roll-compensated receiver.

The SeaBat 8160 processor is compatible with other SeaBat sonar heads. It can be updated in minutes to accommodate future requirements, and features a user-friendly point-and-click interface.



**RESON A/S • DENMARK**  
Tel +45 47 38 00 22  
Fax +45 47 38 00 66  
Email: [reson@reson.dk](mailto:reson@reson.dk)

**RESON OFFSHORE • UK**  
Tel +44 1224 709 900  
Fax +44 1224 709 910  
Email: [sales@reson.co.uk](mailto:sales@reson.co.uk)

**RESON, INC. • USA**  
Tel +1 805 964 6260  
Fax +1 805 964 7537  
Email: [sales@reson.com](mailto:sales@reson.com)

**RESON, GmbH • GERMANY**  
Tel +49 431 720 7180  
Fax +49 431 720 7181  
Email: [reson@reson-gmbh.de](mailto:reson@reson-gmbh.de)

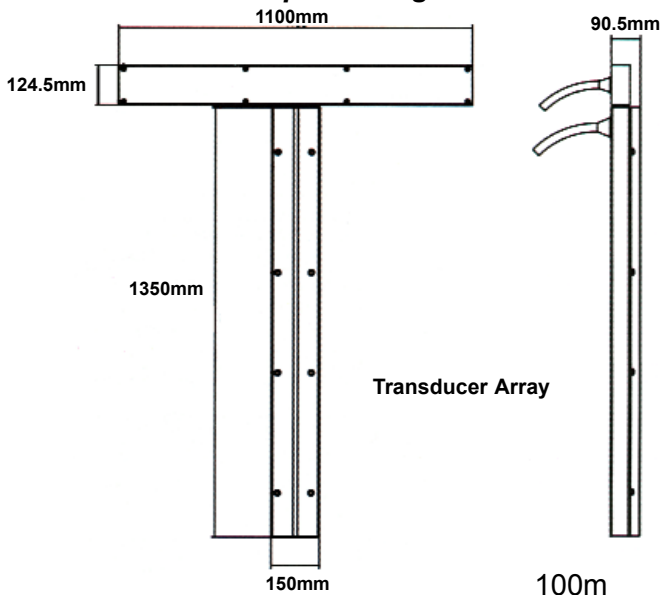
[www.reson.com](http://www.reson.com)

# SeaBat 8160 SYSTEM SPECIFICATIONS

## SYSTEM PERFORMANCE

<b>Frequency:</b>	50 kHz
<b>Depth Resolution:</b>	2.4 cm / 9.6 cm
<b>Swath Coverage:</b>	Greater than 4x water depth
<b>Max Operational Depth:</b>	3000 m
<b>Number of Beams:</b>	126
<b>Along-Track Beamwidth:</b>	1.5°
<b>Across-Track Beamwidth:</b>	1.5°
<b>Pitch Stabilization:</b>	±10°
<b>Accuracy:</b>	IHO Special Order
<b>Operational Speed:</b>	Up to 20 knots
<b>Max. Update Rate:</b>	15

### Transducer Depth Rating:



## INTERFACE

<b>System Supply:</b>	115V/230V 50/60 Hz, 350W
<b>Video Display:</b>	SVGA, 800 x 600, 72 Hz
<b>System Control:</b>	Trackball or from Ethernet
<b>Data Output:</b>	10 MB Ethernet or serial RS232C
<b>Data Uplink:</b>	High-speed digital coax with fiber-optic option
<b>Temperature:</b>	Operating: 0° to +40° C Storage: -30° to +55° C

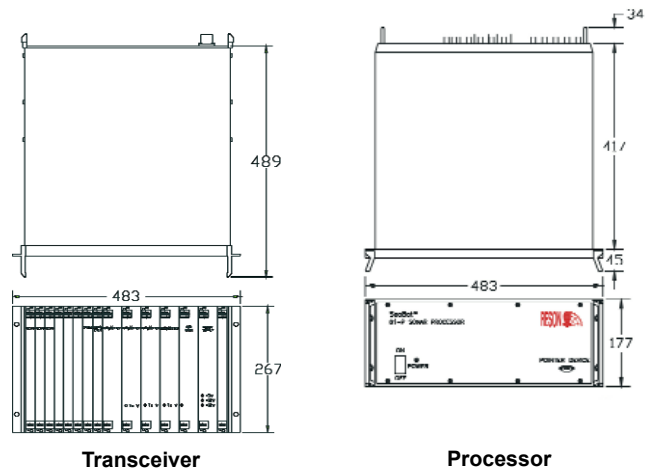
## MECHANICAL INTERFACE

### Dimensions (HWD in mm):

<b>Transducer Array:</b>	1474.5 x 1100 x 90.5
<b>Processor:</b>	177 x 483 x 417
<b>Transceiver:</b>	265 x 483 x 492

### Weight:

<b>Transducer Array:</b>	50 kg (dry) / 30 kg (wet)
<b>Processor:</b>	20 kg
<b>Transceiver:</b>	13.6 kg



Version: B34-PDF-011009

Due to our policy of continuous product improvement, RESON reserves the right change specifications without notice.





# SeaBat 8125

ULTRA HIGH RESOLUTION FOCUSED  
MULTIBEAM ECHOSOUNDER SYSTEM



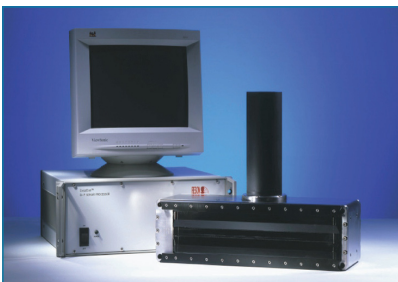
## SeaBat 8125

- Focused 0.5° beams
- 240 beams
- 2.5cm near field resolution
- 6mm depth resolution
- 120° swath

The SeaBat 8125 is the first wide-sector, wide-band, focused multibeam sonar ever to be deployed. Utilizing 240 dynamically focused receive beams, the system measures a 120° swath across the seafloor, detects the bottom, and delivers the measured ranges at a depth resolution of 6mm. The backscatter intensity image is displayed in real time on the sonar display.

The 8125 can be controlled through its native graphical user interface, or through an external control data collection and navigation software package.

The system can be mounted on a survey vessel or deployed on an ROV at depths down to 1500m. The high-speed data uplink is carried on a standard SeaBat copper cable for surface installation. A fiber-optical interface is available for ROV deployment.





# SeaBat 8125

## ULTRA HIGH RESOLUTION FOCUSED MULTIBEAM ECHOSOUNDER SYSTEM

### SYSTEM PERFORMANCE

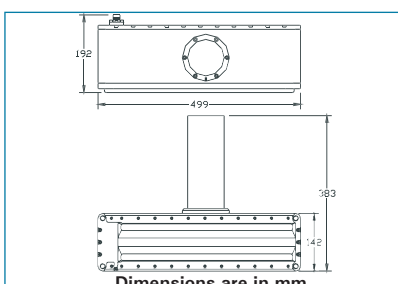
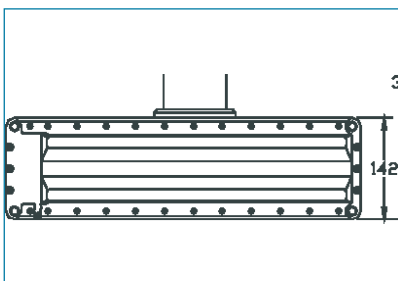
Frequency:	455kHz
Depth Resolution:	6mm
Swath Coverage:	120°
Max Range:	120m
Number of Beams:	240
Along-Track Beamwidth:	1°
Across-Track Beamwidth:	0.5° (at nadir)
Operational Speed:	Up to 12 knots
Max. Update Rate:	40
Transducer Depth Rating:	400m (Standard) 1500m (Optional)

### INTERFACE

System Supply:	115V/230V 50/60Hz, 350W max	
Video Display:	SVGA, 800 x 600, 72Hz	
System Control:	Trackball	
Data Output:	10MB Ethernet or serial RS232C	
Data Uplink:	High-speed digital coax with fiber-optic option	
Sonar Head Supply:	24VDC, 5.6A Peak, 2A Average (May be supplied from sonar processor)	
Temperature:	Operating:	0° to +40°C
	Storage:	-30° to +55°C

### MECHANICAL INTERFACE

Power Requirements:	24VDC, 5.6A Peak, 2A Average (May be supplied from sonar processor)	
Operating Depth:	400m/1500m	
Dimensions:	266 x 320mm (W / D) excluding projector	
Temperature:	Operating:	-5° to +40°C
	Storage:	-30° to +55°C
Weight (aluminum):	Dry:	26.8kg (59lbs.)
	Wet:	4.8kg (10.6lbs.)
Weight (titanium):	Dry:	40kg (88lbs.)
	Wet:	18kg (39.6lbs.)



RESON reserves the right to change specifications without notice. © 2006 RESON A/S  
For Acoustical Measurement Accuracy please refer to [www.reson.com](http://www.reson.com) or contact sales.

RESON A/S  
Denmark  
Tel: +45 4738 0022  
E-mail: [reson@reson.dk](mailto:reson@reson.dk)

RESON Inc.  
USA  
Tel: +1 805 964-6260  
E-mail: [sales@reson.com](mailto:sales@reson.com)

RESON Offshore Ltd.  
United Kingdom  
Tel: +44 1224 709 900  
E-mail: [sales@reson.co.uk](mailto:sales@reson.co.uk)

RESON GmbH  
Germany  
Tel: +49 431 720 7180  
E-mail: [reson@reson-gmbh.de](mailto:reson@reson-gmbh.de)

RESON B.V.  
The Netherlands  
Tel: +31 (0)10 245 1500  
E-mail: [info@reson.nl](mailto:info@reson.nl)

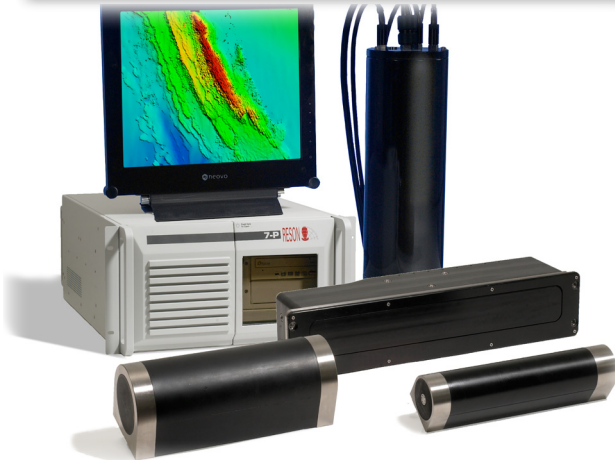
RESON (Pte.) Ltd  
Singapore  
Tel: +65 6725 9851  
E-mail: [sales@reson.com](mailto:sales@reson.com)

[www.reson.com](http://www.reson.com)

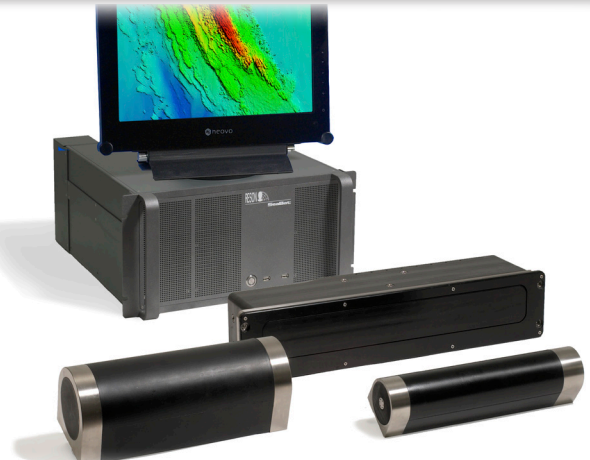


# SeaBat 7125

HIGH-RESOLUTION MULTIBEAM ECHOSOUNDER SYSTEM



ROV and AUV



SV

- 512 beams and equi-distant footprints providing extremely high density and maximizing swath width
- Real-time roll stabilisation maximizing usable swath
- Dual frequency provides seamless coverage from 0.5 to 500m depth
- Compliance with IHO SP44Ed5 over entire depth range
- Advanced diagnostics
- High ping rate allows high-speed operations without compromising data density

## SeaBat 7125

The new generation SeaBat 7125 builds on the field experience and feedback from many users around the world and brings unparalleled resolution and installation flexibility. The system is available in three separate configurations; one designed specifically for installation on small survey vessels and a 6000m depth rated system for either ROV or AUV use.

Each of these configurations utilise the same transducer set and provide identical high performance, superlative data quality, features and ease of use over depths from 0.5m to 500m.

Special emphasis has been put on maximizing operational efficiency and features such as variable swath width and roll stabilisation combined with a high ping rate and excellent data quality.

### Surface Vessel installation

The new SeaBat 7125-SV is a highly integrated single or dual frequency system designed with ease of installation and operation as a high priority.

The system consists of a surface transceiver with integrated multiport card and a standard 25m cable run to the transducers. The transceiver hardware is suitable for running data acquisition software and is available with RESON PDS2000 software pre-installed and configured.

### ROV

For deep-water use the ROV version of the SeaBat 7125 has a 6000m depth rating and includes a 6000m rated titanium interface bottle. The system performance and feature set is identical to the other members of the 7125 family thus providing commonality and ease of use.

### AUV

The AUV version of the 7125 provides on-board data processing and logging as well as interface to third party sensors. The electronics are supplied mounted on an aluminium frame for ease of integration and an optional 6000m depth-rated titanium electronics housing is available. The 7125-AUV provides high quality data and performance commensurate with the other versions of the 7125.

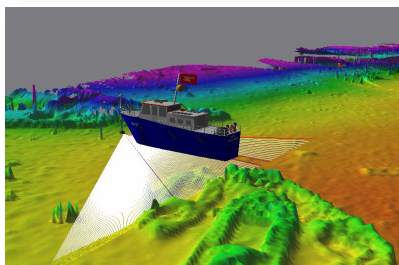
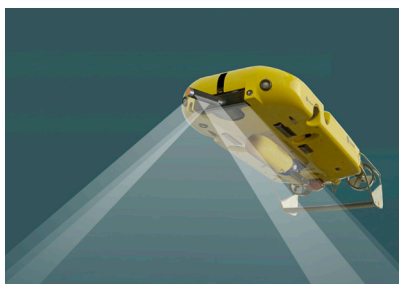
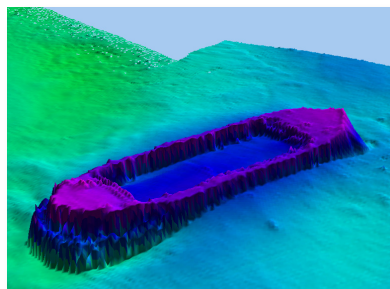


# SeaBat 7125

## HIGH-RESOLUTION MULTIBEAM ECHOSOUNDER SYSTEM

### OPTIONS

- Mounting Bracket with Faring
- SVP-70 sound velocity Profiler with 25m Cable
- Extended Warranty / Support & Maintenance Contracts
- Fiber-Optic Conversion for ROV Installations
- Full Calibration (calibrated backscatter) (includes 1 TB external RAID)
- System Integration & Training



### SYSTEM CHARACTERISTICS

	7125 SV	7125 ROV	7125 AUV
* EA= Equi-angle / ED= Equi-distant			
Frequency	200 or 400 kHz (dual freq. available)		
Along-track transmit beamwidth	2.2° (± 0.5°) at 200 kHz / 1° (± 0.2°) at 400 kHz		
Across-track receive beamwidth	1.1° (± 0.05°) at 200 kHz / 0.54° (± 0.03°) at 400 kHz		
Max ping rate	50 Hz (± 1 Hz)		
Puls length	50 µsec to 300 µsec		
Number of beams	256EA*/256ED* at 200kHz 256EA*, 512EA*, 512ED* at 400kHz		
Max Swath angle	128°		
Depth resolution	6mm		
Data output	Bathymetry, sidescan & snippets 7K data format Gbit Ethernet		
Power requirement	110/220 VAC 50/60 Hz 500W average	48V DC(±10%)  110W max	48V DC (±10%)  200W max
Transducer cable length	25m standard 50m optional 10m optional	3m standard 10m optional	3m standard 10m optional
LCU to processor cable length	N/A	25m standard 6m optional 5m pigtail	N/A
System depth rating	50m	6000m	6000m optional
Temperature operating	0° to +40° C		
Temperature storage	-30° to +55° C		

### COMPONENT

	7125 SV	7125 ROV	7125 AUV
EM 7200 Receiver	✓	✓	✓
TC2160 400kHz Projector	✓	✓	✓
TC2163 200 kHz projector (optional)	✓	✓	✓
7-L Link Control Unit	✗	✓	✗
7-P sonar Processor Unit with monitor, Keyboard and Pointer Device	✗	✓	✗
SV Transceiver with monitor, Keyboard and Pointer Device	✓	✗	✗
7-I Integrated Control & Processor Unit	✗	✗	✓
Standard Cable Set	✓	✓	✓
Shipping cases, manuals & accessories	✓	✓	✓

### WEIGHT & DIMENSIONS

Component	TC2160 400 kHz projector	TC2163 200 kHz projector	EM7200 200/400 kHz- receiver	Surface transceiver	LCU bottle	ICPU frame	7-P processor
Height (mm)	77	115	102	5U	530	172	5U
Width (mm)	62	100	495	19"	Ø174	166	19"
Depth (mm)	285	280	131	557	N/A	497	630
Weight-kg/air	2.75	7.5	10.6	20	15.7	10	30
Weight-kg/water	1.75	5	5.5	N/A	5.2	N/A	N/A

RESON reserves the right to change specifications without notice. © 2006 RESON A/S  
For Acoustical Measurement Accuracy please refer to [www.reson.com](http://www.reson.com) or contact sales.

**RESON A/S**  
Denmark  
Tel: +45 4738 0022  
E-mail: [reson@reson.com](mailto:reson@reson.com)

**RESON GmbH**  
Germany  
Tel: +49 431 720 7180  
E-mail: [reson@reson-gmbh.de](mailto:reson@reson-gmbh.de)

**RESON Inc.**  
USA  
Tel: +1 805 964-6260  
E-mail: [sales@reson.com](mailto:sales@reson.com)

**RESON B.V.**  
The Netherlands  
Tel: +31 (0) 10 245 1500  
E-mail: [info@reson.nl](mailto:info@reson.nl)

**RESON Offshore Ltd.**  
United Kingdom  
Tel: +44 1224 709 900  
E-mail: [sales@reson.co.uk](mailto:sales@reson.co.uk)

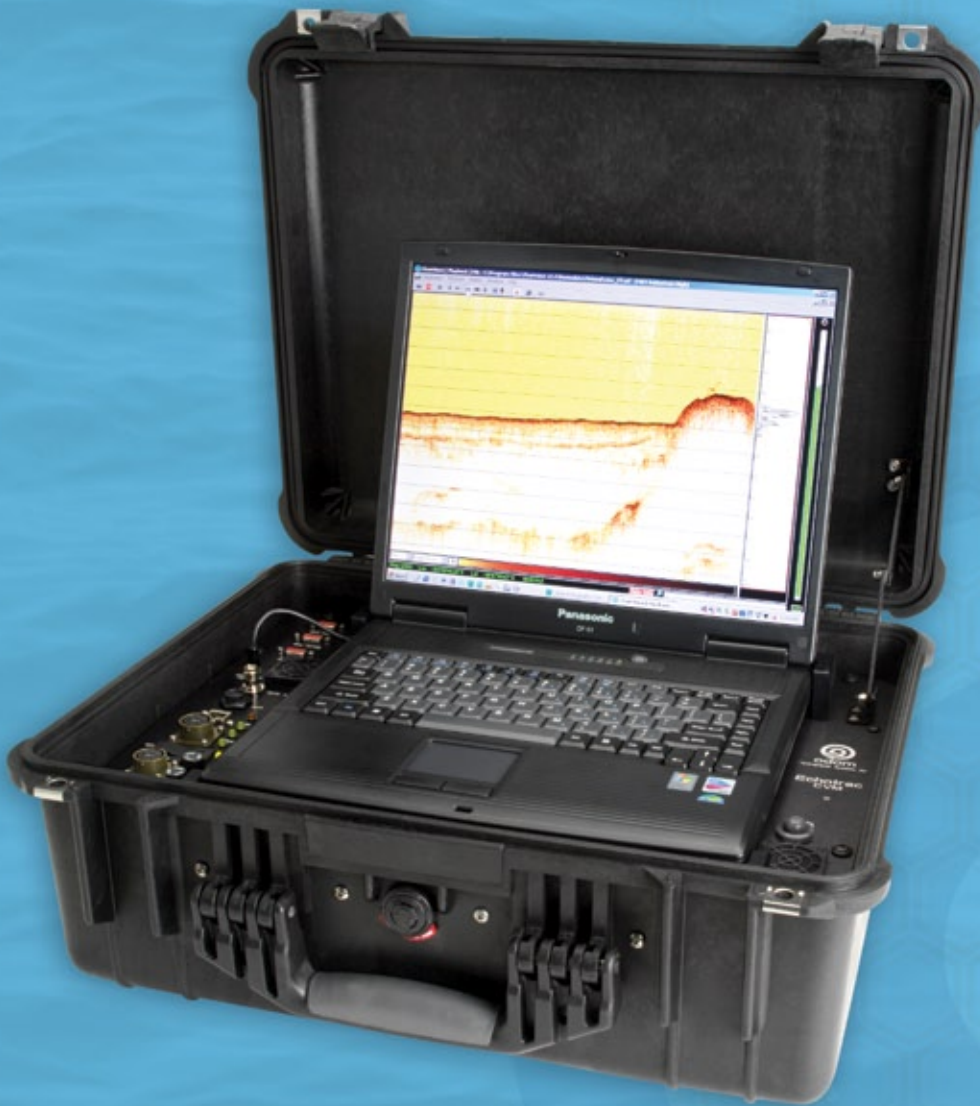
**RESON (Pte.) Ltd.**  
Singapore  
Tel: +65 6725 9851  
E-mail: [sales@reson.com](mailto:sales@reson.com)

[www.reson.com](http://www.reson.com)

# ODOM ECHOTRAC CVM™



**odom**  
HYDROGRAPHIC SYSTEMS



## MOBILE HYDROGRAPHIC SYSTEM

- Portable carry-on case style includes a single or dual frequency echo sounder with optional DGPS receiver, notebook PC and bundled data acquisition software.
- Features include Ethernet LAN interface, frequency agile configurable transceivers, standard serial interfaces for data acquisition systems, motion sensors and DGPS receivers.

# ODOM ECHOTRAC CVM™

The rugged and weatherproof **Echotrac CVM™** outperforms other echo sounders in its class, offering the utmost in portability without sacrificing Odom performance standards.

With dual or single frequency configurations, optional built-in DGPS and bundled notebook PC and your choice of data acquisition software, the **CVM™** has everything you need in an echo sounder – even when portability isn't an issue.

*Buy Odom – invest in your peace of mind.*

## S P E C I F I C A T I O N S

### Frequency

- High band: 100 kHz – 340 kHz
- Low band: 24 kHz – 50 kHz

### Output Power

- High: 200 kHz – 400 W RMS max
- Low: 33 kHz – 200 W RMS max

### Input Power

- 12 to 24 V DC (nominal) 15 watts
- 110 or 220 V AC

### Resolution

- 0.01 m/0.1 ft

### Accuracy

- 0.01 m / 0.10 ft +/- 0.1% of depth @ 200 kHz
- 0.10 m / 0.30 ft +/- 0.1% of depth @ 33 kHz

### Depth Range

- 0.2 – 200 m / 0.5 – 600 ft. @ 200 kHz
- 0.5 – 600 m / 1.5 – 1968 ft. @ 200 kHz

### Phasing

- Automatic scale change, 10%, 20%, 30% overlap or manual

### Sound Velocity

- 1370 – 1700 m/s
- Resolution 1 m/s

### Transducer Draft Setting

- 0 – 15 m (0 – 50 ft)

### Depth Display

- On control PC

### Clock

- Internal battery backed time, elapsed time and date clock

### Annotation

- Internal – date, time, GPS position
- External – from RS232 or Ethernet

### Interfaces

- 2 x RS232
- Inputs from external computer, motion sensor, sound velocity
- Outputs to external computer
- Ethernet interface
- Heave – TSS and sounder sentence

### Blanking

- 0 to full scale

### Software

- Echotrac Control software
- ChartView display and logging software

### Help

- The function of each parameter and its minimum and maximum values can be displayed.

### Environmental Operating Conditions

- 0° – 50° C, 5 – 90% relative humidity, non-condensing

### Dimensions

- 53 cm (20.75 in) W x 44 cm (17.25 in) D x 21.5 cm (8.5 in) H

### Weight

- 13.8 kg (31 lbs)

### Options

- One or two acoustic channels
- Side scan transducer – single or dual channel side looking 200 kHz or 340 kHz for search and reconnaissance
- Built-in DGPS
- Ruggedized notebook PC bundled with data acquisition software



**odom**  
HYDROGRAPHIC SYSTEMS

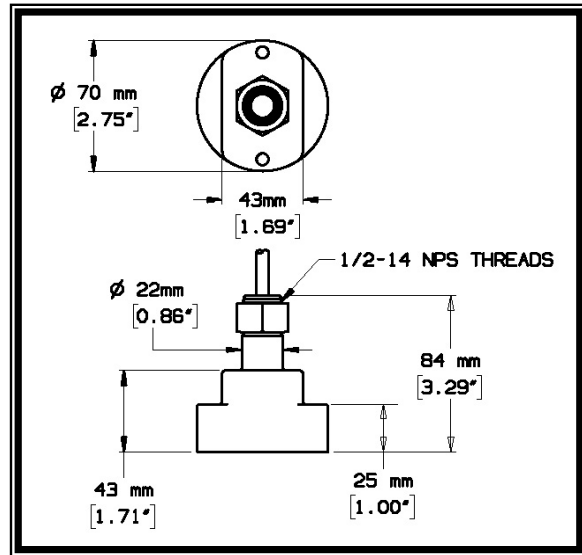
1450 Seaboard Avenue  
Baton Rouge, Louisiana 70810-6261 USA  
E-mail: [email@odomhydrographic.com](mailto:email@odomhydrographic.com)  
[www.odomhydrographic.com](http://www.odomhydrographic.com)



odomhydrographic.com

Odom Hydrographic Systems, Inc.  
 1450 Seaboard Avenue  
 Baton Rouge, LA. 70810 -6261  
 225.769.3051, Facsimile 225.766.5122

## SMBB200-9



### Performance Data

Frequency	200kHz - BClq
Beam Width	9°
Q (transmit)	2.5
Rated RMS Power	500 W
Balanced Impedance	60 ohms
Peak Figure of Merit	-16
Bandwidth	
Acoustic Window Material	Urethane
Threads	1/2" -14NPS
Cable Type	C33 (2-20 AWG)
Cable Size	6mm
Weight	1.3Kg.

Broadband with superlow Q of 2.5. Small housing with short stem used primarily for navigation and survey applications. This model is usually mounted on an extension tube but is adaptable to portable survey and navigation systems. It contains a transformer which can be used to match the impedance of the echosounder or allow the use of longer cables. The transducer is available in either a bronze or stainless steel housing. Model SS510 provides good definition in hard bottoms with side lobes.

SMBB200-9 information sheet

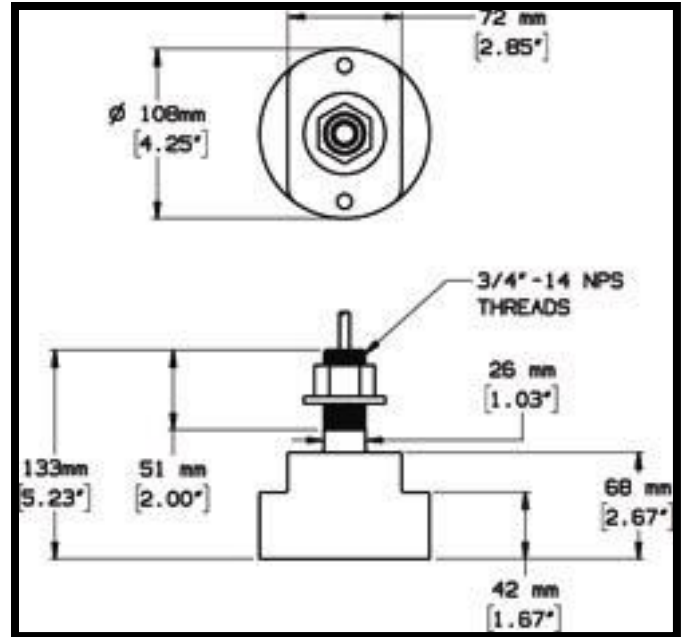
Stem Mount, 200khz-9d, BROADBAND, SS510-2, C33, 10m,5P



odomhydrographic.com

Odom Hydrographic Systems, Inc.  
1450 Seaboard Avenue  
Baton Rouge, LA. 70810 -6261  
225.769.3051, Facsimile 225.766.5122

## SMSW200-4a



### Performance Data

Frequency	200kHz
Beam Width	4°
Q (transmit)	
Rated RMS Power	
Balanced Impedance	60 ohms
Peak Figure of Merit	
Bandwidth	
Acoustic Window Material	Urethane
Threads	3/4" -14NPS
Cable Type	C37 (2-20 AWG)
Cable Size	6mm
Weight	1.3Kg.

The compact stainless steel housing is easily adapted to portable or hull mounted applications. This unit is primarily used for shallow and mid-depth survey applications where delineation of steep slopes and sounding in very shallow water are important features. It contains a transformer that matches the impedance of the transducer to that of the echo sounder and allows for the use of longer cables without affecting performance.

### SMSW200-4a\_information\_sheet

Stem Mount, Shallow Water BB 200kHz-4d,SS538,C37,10m,SS,5p



## KLEIN SYSTEM 5000

### HIGH-RESOLUTION, DYNAMICALLY FOCUSED, MULTI-BEAM SIDE SCAN SONAR

The System 5000 is a 5-beam side scan sonar designed for hydrographic, military and commercial applications requiring high-resolution images of the sea floor and bottom obstructions, while operating at tow speeds up to 10 knots and with an overall swath width of 300 meters.

Conventional side scan sonar systems use a single sonar beam per side to generate an image of the seafloor. The physics of this type of sonar results in degradation of image resolution with range poor along track resolution, and requires speeds of 5 knots or less to insure 100 percent bottom coverage.

From a design perspective, these shortcomings can be eliminated by designing a sonar that, through beam steering and focusing techniques, simultaneously generates several adjacent, parallel beams per side. Such a multi-beam design approach permits higher towing speeds with 100 percent bottom coverage, while providing high-resolution imaging to the maximum range of the sonar.

This design approach is principally employed by military side scan sonar systems designed for high speed mine hunting applications. L-3 Klein is the first commercial company to offer a multi-beam side scan sonar using similar design techniques to military sonars, but at a fraction of the cost.

The two main benefits of the high-speed, high-resolution System 5000 series are: higher towing speeds with no loss of bottom coverage, and range independent high-resolution image capability.

Since operation costs are dependent on the amount of at-sea time required to complete a survey, the Klein System 5000 Multi-Beam Side Scan Sonar with survey speeds more than twice that of conventional side scan sonars, minimize at-sea time, thus greatly reducing survey costs.



#### KEY FEATURES

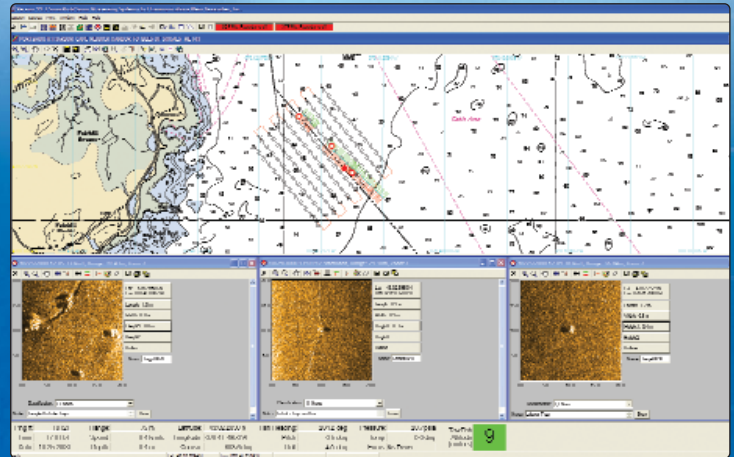
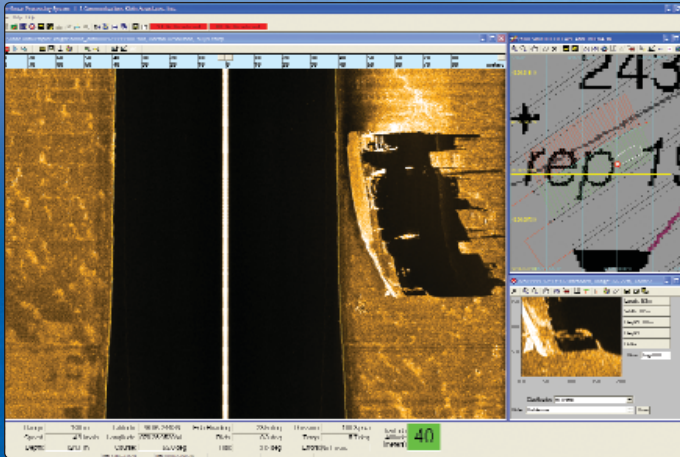
- Multiple simultaneous beams per side each ping
- High tow speed capability
- Dynamic digital auto-focusing
- Very high resolution and 100% coverage
- Sonar connected to PC display on Ethernet LAN

**THE DIFFERENCE  
IS IN THE IMAGE**



## KLEIN SYSTEM 5000

### HIGH-RESOLUTION, DYNAMICALLY FOCUSED, MULTI-BEAM SIDE SCAN SONAR



#### Towfish Specifications

Number of beams	5 port & 5 starboard
Frequency	455 kHz $\pm$ 1%
Range scales	50, 75, 100, 150 m
Pulse length	50 to 200 $\mu$ sec.
High-resolution mode (along track)	10 cm to 38 m
Standard resolution mode (along track)	20 cm to 75 m, thereafter increasing to maximum of 36 cm @ 150 m maximum range
Resolution (across track)	7.5 to 30 cm
Operating speed envelope	2-10 knots @ 150 m sonar range
Sonar digitization	16 bit / channel
Maximum operating range	150 m (300 m Swath)
Array length	120 cm (47.2 in)
Body length	194 cm (76.4 in)
Body diameter	15.2 cm (6 in)
Weight (in air)	70 kg (155 lbs)
Sensors:	
Heading	Standard
Pitch & roll	Standard
Pressure / altimeter	Standard
Depth rating*	200 m standard

#### Options

Yaw rate and high-resolution roll sensors
Responder / transponder
Splash-proof TPU housing
Fiber optic interface

\* For deeper depth rated systems, please contact Klein

#### Transceiver Processor Unit (TPU) Specifications

Width	Standard 19-in rack-mount
Height	13.2 cm (5.2 in)
Depth	54.6 cm (21.5 in)
Weight	12.7 kg (28 lbs)
Input voltage	115/240 VAC, 50/60 Hz
Power	120 W (includes towfish)
Navigation input	NMEA 0183
Data output	100 BaseT Ethernet LAN

#### Tow Cable

Type: steel	Coaxial or fiber-optic double armored
-------------	---------------------------------------

#### Workstation PC

Workstation PC	
SonarPro® installed	Optional, with SonarPro software installed
Windows OS installed	installed

#### Klein Associates, Inc.

11 Klein Drive  
Salem, NH 03079-1249 USA  
Phone: 603.893.6131  
Fax: 603.893.8807  
Klein.Mail@L-3com.com  
www.L-3Klein.com



**communications**  
Klein Associates, Inc.

**L-3.** Headquartered in New York City, L-3 Communications employs over 64,000 people worldwide and is a prime contractor in aircraft modernization and maintenance, C<sup>3</sup>ISR (Command, Control, Communications, Intelligence, Surveillance and Reconnaissance) systems and government services. L-3 is also a leading provider of high technology products, subsystems and systems.

## DATASHEET

### **The New POS MV - Providing the Marine Industry with robust, reliable, and repeatable position and orientation solutions**

The new POS MV V4 - a tightly-coupled system utilizing advanced Inertially-Aided Real-Time Kinematic (IARTK) technology designed to increase your operational capability and reduce downtime.

**Tightly integrated inertial navigation** – Continuous positioning data can be generated while surveying in areas where GPS reception is compromised by multipath effect and signal loss, such as close to offshore structures, or in ports, harbors, near-shore coastal waters and rivers. Raw GPS data from as few as one satellite can now be processed directly within the POS MV reducing position drift and RTK re-acquisition time.

#### **The V4 Advantage**

##### **The Major Benefits**

- Faster, more robust heading aiding from GPS Azimuth Measurement Subsystem (GAMS) when compared to V3
- Proprietary Inertially Aided RTK providing almost instantaneous reacquisition of RTK following a GPS outage
- Superior low elevation tracking performance using lighter, smaller Trimble Zephyr™ geodetic antenna technology
- Faster initial system calibration
- Maintains heading accuracy longer when in a high multipath environment
- Increased component reliability
- Automatic identification and error estimation for lever arm distances and angles

##### **The Latest Technology**

**V4 uses the latest Trimble BD950 receivers with the following attributes:**

- Extremely fast response time
- Latency of less than 20 milliseconds (at 20 times per second)
- Very low noise L1 and L2 carrier phase measurements
- Uses the Maxwell 4 Custom Survey GPS chip for enhanced tracking capability

##### **Straightforward Installation and Operation**

- All components mounted and installed using a straightforward, one-time-only, systematic procedure.

##### **Faster, More Reliable Networking Potential**

- An improved Ethernet raw data logging capability for streamlined data acquisition of all motion variables with microsecond-accurate time stamping

##### **Upgradeability\***

- Convenient upgrade program for PCS and antennas, to allow for maximum interoperability when moving from L1 only to a full L1/L2 RTK unit

##### **The Most Accurate Position and Orientation Solution**

POS MV V4 maintains positioning accuracy under the most demanding conditions regardless of vessel dynamics. With its high data update rate, the system delivers a full six degree-of-freedom position and orientation solution to provide the following:

- Position (latitude, longitude and elevation)
- Velocity (north, east and vertical)
- Attitude (roll, pitch and true heading)
- Heave (real-time, delayed)
- Acceleration Vectors
- Angular Rate Vectors

\* For detailed upgrade information please call your Applanix Marine office



#### **SYSTEM COMPONENTS**

**POS Computer System (PCS)** – A rugged, compact computer system contains the core POS processor and IMU interface electronics, plus two GPS receivers and an optional removable PC-card disk drive. The PCS provides system timing, position and velocity aiding, together with GPS raw observables for use with GAMS.

**POS Inertial Measurement Unit** – The system's primary sensor allows for the continuous output of position and orientation data.

**Primary GPS Receiver Antenna** – A dual frequency antenna for use with GAMS.

**Secondary GPS Receiver Antenna** – A dual frequency antenna for use with GAMS.

# SPECIFICATIONS

## Accuracy

### POS MV 320 Main Specifications (with Differential Corrections)

Roll, Pitch accuracy:	0.02° (1 sigma with GPS or DGPS) 0.01° (1 sigma with RTK)
Heave Accuracy:	5 cm or 5% (whichever is greater) for periods of 20 seconds or less
Heading Accuracy:	0.02° (1 sigma) with 2 m antenna baseline, 0.01 (1 sigma) with 4 m baseline
Position Accuracy:	0.5 - 2 m (1 sigma) depending on quality of differential corrections 0.02 - 0.10 m (RTK) with input from auxiliary RTK or optional internal RTK receiver
Velocity Accuracy:	0.03 m/s horizontal

### POS MV 320 during GPS Outages

Roll, Pitch accuracy:	0.02° (1 sigma)
Heave accuracy:	5 cm or 5% (whichever is greater) for wave periods of 18s or less
Heading accuracy:	Drift less than 1° per hour (negligible for outages < 60s)
Position accuracy degradation:	2.5 m (1 sigma) for 30 s outages <6 m (1 sigma) for 60 s outages

### POS MV 220 Main Specifications (with Differential Corrections)

Roll, Pitch accuracy:	0.05° (1 sigma with GPS or DGPS) <0.05° (1 sigma with RTK)
Heave Accuracy:	5 cm or 5% (whichever is greater) for periods of 20 seconds or less
Heading Accuracy:	0.1° (1 sigma) with 2 m antenna baseline, 0.05° (1 sigma) with 4 m baseline
Position Accuracy:	0.5 - 4 m (1 sigma) depending on quality of differential corrections 0.02 - 0.10 m (RTK) with input from auxiliary RTK or optional internal RTK receiver
Velocity Accuracy:	0.05 m/s horizontal DPGS, .03 m/s horizontal RTK

### POS MV 220 during GPS Outages

Roll, Pitch accuracy:	0.05° (1 sigma)
Heave accuracy:	5 cm or 5% (whichever is greater) for wave periods of 18s or less
Heading accuracy:	Drift less than 3° per hour (negligible for outages < 60s)
Position accuracy degradation:	2.5 m (1 sigma) for 30 s outages <6 m (1 sigma) for 60 s outages

## Physical Characteristics

### Size

IMU:	204 mm X 204 mm X 168 mm	7.95 in X 7.95 in X 6.55 in
PCS:	432 mm X 89 mm X 356 mm	17.00 in X3.50 in X 14.05 in
	2.0U 19 in rack mount	
GPS Antenna (x2):	187 mm X 53 mm	7.4 in X 2.1 in

### Weight

IMU:	3.5 kg	7.7 lb (international)
Processor:	5 kg	11.0 lb (international)
GPS Antenna:	<0.5 kg	<1.1 lb (international)

### Power

Processor:	110/230 Vac, 50/60 Hz, auto-switching 80 Watt
IMU:	Power provided by PCS
GPS Antennas:	Power provided by PCS

## Environmental

### Temperature Range (Operating)

IMU:	-40 °C to +60 °C	-40 °F to +140 °F
Processor:	0 °C to +55 °C	+32 °F to +131 °F
GPS Antenna:	-40 °C to +70 °C	-40 °F to +158 °F

### Temperature Range (storage)

IMU:	-40 °C to +60 °C	-40 °F to +140 °F
Processor:	-25 °C to +85 °C	-13 °F to +185 °F
GPS Antenna:	-50 °C to +70 °C	-58 °F to +158 °F

### Humidity

IMU:	10 - 80% RH, Ingress Protection of 65
Processor:	10 - 80% RH, non-condensing
GPS Antenna:	0 - 100% RH

### Shock & Vibration (IMU)

Operating:	90 g, 6 ms terminal saw tooth
Non-Operating:	220 g, 5 ms half-sine

## Applanix Marine Offices

Applanix Corporation  
85 Leek Crescent  
Richmond Hill, Ontario  
Canada L4B-3B3

Tel: +1 905-709-4600  
Fax: +1 905-709-6027

Applanix LLC  
17461 Village Green Drive  
Houston, TX  
USA 77040

Tel: +1 713-896-9900  
Fax: +1 713-896-9919

Applanix United Kingdom  
Forester's House,  
Old Racecourse, Oswestry  
SY10 7PW UK

Tel: +44 1691 659359  
Fax: +44 1691 659299

# APPLANIX

A TRIMBLE COMPANY  
17461 Village Green Drive, Houston TX 77040  
Tel: 713-896-9900 Fax: 713-896-9919

## REPAIR REPORT

**TO:** NOAA- Ship Fairweather  
1801 Fairview Ave E.  
Seattle, WA 98102

**RMA #:** L07-024

**Date:** 15 January, 2008

**Repaired By:** Bruce A. Francis

**TEL:** 713-896-9900

**ATTN:** Larry Loewen  
**TEL:**  
**FAX:**

PART NO.	DESCRIPTION	SERIAL NUMBER
PCS-29	POSMV 320 V4	2560
PCS-29	POSMV 320 V4	2564

### ORIGINAL COMPLAINT / FAULT DESCRIPTION / VERIFICATION

IMU errors, GPS data gaps.

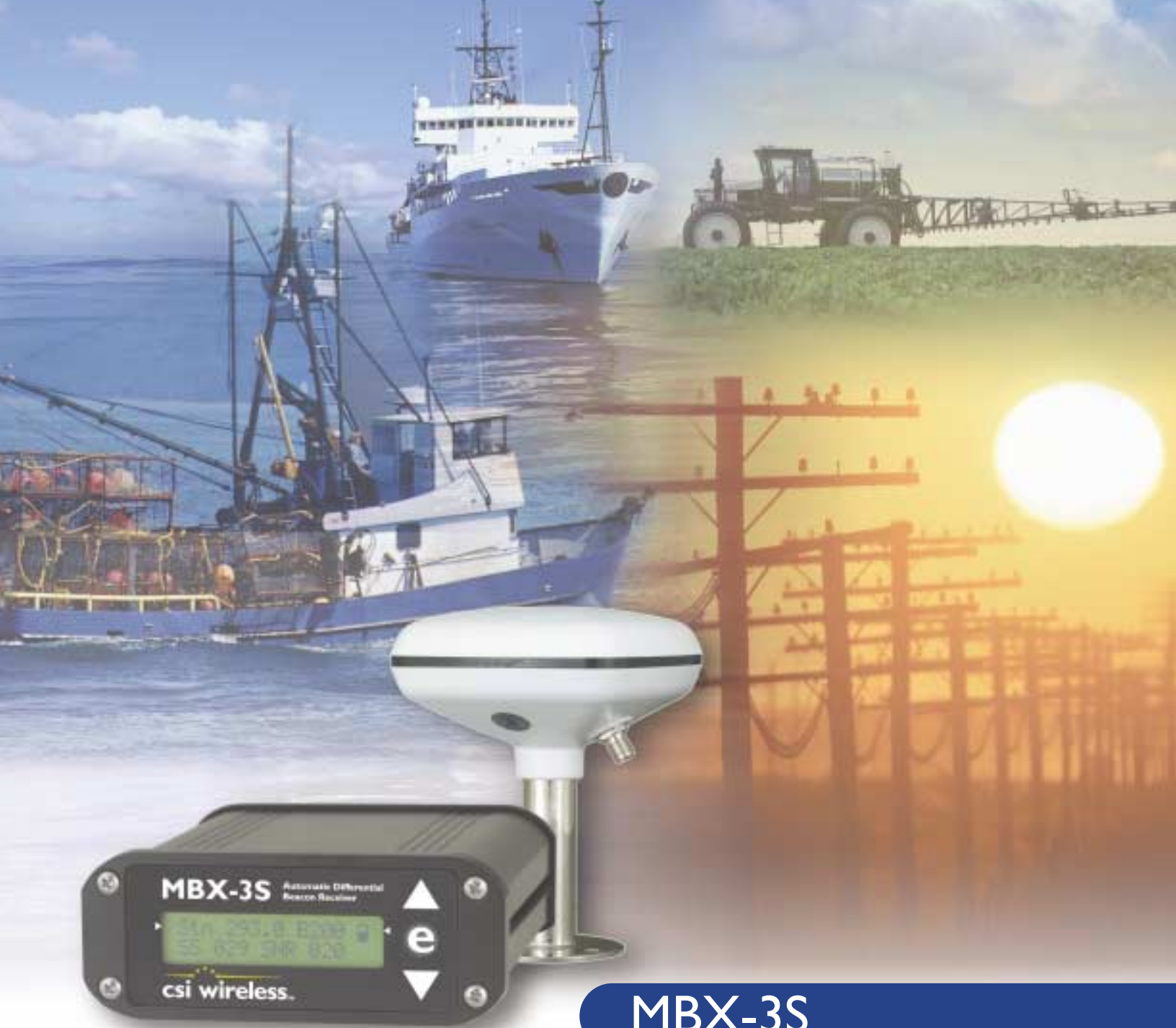
### REPAIR DETAILS

ITEM	REPAIR DETAILS
1	We were able to reproduce problems with both PCS units in the shop- intermittent IMU failures.
2	Found resistor R9 on the power supply board not soldered correctly. This has been identified as a fault in POS systems and have confirmed that these serial numbered units did received the faulty batch of power supplies with this problem.
3	Resoldered R9 and retested both systems on the bench for a number of days. No faults observed.
4	Installed latest firmware version 3.42 on both units whereas the previous version was 3.41. Version 3.42 adds ASCII IP address output to COM5 at bootup only to identify setting should it get changed by previous user.
5	
6	
7	
8	
9	Please verify all settings before use

ITEM	QTY	MATERIAL	
1	16hrs	Labor	N/C

### ADDITIONAL INFORMATION & COMMENTS

As this issue with R9 was of our own making, there is no charge for this repair.



## MBX-3S

The most popular commercial-grade  
Coast Guard Beacon Receiver

- Dual-channel Coast Guard beacon receiver
- Supplements GPS systems with free differential corrections, enhancing accuracy
- Fast signal acquisition
- Wide input voltage range for a variety of power sources
- Low power consumption extends battery life
- Automatic tuning mode for hands-free operation
- Integrated signal splitter outputs GPS signal from combined GPS /differential antennas
- Front-panel interface for easy configuration and status monitoring



**ESRI**  
Technology  
AUTHORIZED  
BUSINESS PARTNER

  
**csi wireless**<sup>™</sup>  
[www.csi-wireless.com](http://www.csi-wireless.com)

### Receiver Specifications

<b>Channels:</b>	2 independent channels
<b>Channel Spacing:</b>	500 Hz
<b>Frequency Range:</b>	283.5 to 325.0 Hz
<b>MSK Bit Rates:</b>	50, 100, 200 bps
<b>Cold Start Time:</b>	<1 min
<b>Warm Start Time:</b>	<2 seconds
<b>Demodulation:</b>	Minimum shift keying
<b>Sensitivity:</b>	2.5 $\mu$ V/m for 6 dB SNR
<b>Dynamic Range:</b>	100 dB
<b>Frequency Offset:</b>	$\pm 8$ Hz (27 ppm)
<b>Adjacent Channel Rejection:</b>	61 dB $f_c \pm 400$ Hz
<b>Correction Output Protocol:</b>	RTCM SC-104
<b>Input Status Protocol:</b>	NMEA 0183

### Communications

<b>Interface:</b>	RS-232C or RS-422
<b>Baud Rates:</b>	2400, 4800, 9600

### Environmental Specifications

<b>Operating Temperature:</b>	-30°C to +70°C
<b>Storage Temperature:</b>	-40°C to +80°C
<b>Humidity:</b>	95% non-condensing
<b>EMC:</b>	EN 60945 EN 50081-1 EN 50082-1 FCC: Part 15, sub-part J, class A digital device

### Power Specifications

<b>Input Voltage Range:</b>	9 to 40 VDC
<b>Nominal Power:</b>	2.5 W
<b>Nominal Current:</b>	210 mA
<b>Antenna Voltage Output:</b>	10 VDC (5 VDC optional)
<b>Antenna Input Impedance:</b>	50 $\Omega$

### Mechanical Specifications

<b>Dimensions:</b>	150 mm L x 125 mm W x 51 mm H (5.9" L x 4.9" W x 2.0" H)
<b>Weight:</b>	0.64 kg (1.4 lb)
<b>Display:</b>	2-line x 16-character LCD
<b>Keypad:</b>	3-key switch membrane
<b>Power Connector:</b>	2-pin circular locking
<b>Data Connector:</b>	DB9-S
<b>Antenna Connector:</b>	BNC-S
<b>Optional GPS Output Port:</b>	TNC-S

### Operating Modes

<b>MBX-3 Mode (Default):</b>	RTCM SC-104 correction and NMEA status message output (Default Mode)
<b>MBX-E Mode:</b>	RTCM SC-104 correction and NMEA status message output and GPS NMEA message input for position and satellite status display

### NMEA 0183 I/O

- Receiver Automatic and Manual tune command
- Frequency and data rate query
- Receiver performance and operating status queries
- Automatic search almanac queries (proprietary)
- Baud rate selection command
- Receiver tune command
- Force cold start command (proprietary)
- Software upgrade command (proprietary)
- Configuration up-load command (proprietary)

### Accessories

<b>Antenna:</b>	Various
<b>Power Cables:</b>	Various
<b>Antenna Cables:</b>	Various
<b>Data Cables:</b>	Various
<b>CSI Beacon Command Center:</b>	MS Windows 95 <sup>®</sup> beacon control software

### Pin-out

#### RS, 232C (DB9 PIN#)

Pin 2	TXD, RTCM SC-104/Status Output
Pin 3	RXD, configuration input
Pin 5	Signal return

#### RS-422 (DB9 PIN#)

Pin 1	TXD +, RTCM SC-104 / Status Output
Pin 2	TXD -, RTCM SC-104 / Status Output
Pin 4	RXD -, configuration input
Pin 5	Signal return
Pin 7	RXD +, configuration input

© Copyright September 2002, CSI Wireless Inc. All rights reserved. Specifications subject to change without notice. CSI Wireless and the CSI Wireless logo are trademarks of CSI Wireless Inc. Made in Canada.

Warranty: Each CSI Wireless product is covered by a limited one-year warranty on parts and labor.

CSI Wireless Dealer



Avery label #05260 (laser print)

Printed in Canada.

csi wireless™

4110 - 9th Street SE • Calgary • AB • Canada • T2G 3C4  
Phone (403) 259-3311 • Fax (403) 259-8866



# SF-2050G SF-2050M

## gps products

NavCom's SF-2050G and SF-2050M modular StarFire™ receivers provide instant position information for decimeter-level position accuracy, anywhere in the world, anytime. Onboard memory, and a geodetic quality antenna enable millimeter level accuracy from post-processing.

### APPLICATIONS

The rugged and reliable SF-2050 series is designed for productivity with minimal setup time. The SF-2050G is designed for backpack GIS and mapping applications while the SF-2050M is ideal for vehicle mounting to suit a wide variety of machine guidance and control applications. The primary operating mode uses the StarFire™ service, and offers decimeter level accuracy for immediate results in the field; great for navigation and relocation of existing assets. The two onboard WAAS/EGNOS channels provide free GPS corrections, which coupled with dual frequency measurements and NavCom's enhanced SBAS algorithm typically provides half-meter real-time accuracy. Simply connect your controller solution to the serial port and receive NMEA format position information, or use a NavCom Partner controller solution for additional configuration and monitoring capabilities.

### BENEFITS

The SF-2050 receivers use our NCT-2100D GPS Engine, the fourth generation of the Touchstone™ ASIC family, of which more than 25,000 are in use worldwide. This incorporates our patented interference suppression and multi-path mitigation, up to 50Hz raw data rate, geodetic quality measurements, and up to 25Hz positioning.

The SF-2050 utilizes a compact tri-band antenna capable of receiving GPS and StarFire signals. This antenna provides excellent phase center stability in a small, robust, lightweight format.

Coupled with NavCom Technology's StarFire subscription service, the SF-2050 delivers 10 cm position fixes without the use of a second receiver serving as a base station. Add the RTK option to your SF-2050, and an external radio capable of receiving RTK corrections from a Base station, and now your SF-2050 is able to do RTK level surveys for unsurpassed accuracy.

### FLEXIBLE INTERFACE

The SF-2050 receivers are easily configured by the provided Windows®-based utility program. For system integrators needing maximum flexibility, the receivers offer a binary user interface that allows for complete command and control of the GPS and L-Band Module, thus enabling customization of the interface and receiver operation. The sensor can receive GPS corrections in NCT (NavCom's ultra compact binary format), RTCM and CMR thus permitting optimum correction source usage with seamless position output.

### FEATURES

- Fully integrated receiver in robust housing
- "All-in-view" tracking on 26 channels (12 L1/L2 GPS + 2 SBAS)
- Global decimeter level accuracy using StarFire™ corrections
- Fully automatic acquisition of StarFire broadcast corrections
- Two dedicated WAAS/EGNOS channels
- L1 & L2 full wavelength carrier phase tracking
- C/A, P1 & P2 code tracking
- 64MB internal memory for data recording
- User programmable measurement and navigation data rates
- Minimal data latency
- Superior interference suppression
- Patented multipath rejection
- Output format NMEA 0183 or NavCom binary format
- CAN bus interface (SF-2050M Only)
- 1PPS Output (SF-2050M Only)
- Event Marker (SF-2050M Only)
- TruBlu™ Wireless Connectivity, Bluetooth® compatible

### UPGRADES

- Raw measurement data rates up to 50Hz
- Positioning rates up to 25Hz
- RTK positioning rates up to 25Hz (external comm-link required)
- RTK Extend™ - RTK positioning during comm. outages



**Modular GPS  
and StarFire™  
receiver provides  
worldwide decimeter  
level accuracy  
anywhere, anytime**



A John Deere Company

www.navcomtech.com



## SF-2050 Series

### TECHNICAL SPECS

#### PHYSICAL/ENVIRONMENTAL

- Size (L x W x H): .....8.18in x 5.67in x 3.06in  
(208mm x 144mm x 78mm)
- Weight: .....4lbs (1.81 kg)
- External Power:  
Input Voltage: .....10 VDC to 30 VDC  
Consumption: .....< 8 W
- Connectors:  
I/O: .....2 x 7 pin Lemo  
DC Power: .....4 pin Lemo  
GPS Antenna: .....TNC-F  
CAN bus + Event: .....5 pin Lemo (SF-2050M Only)  
1PPS Output: .....BNC (SF-2050M Only)
- Temperature (ambient):  
Operating: .....-40° to +55°C (-40° to +131°F)  
Storage: .....-40° to +85°C (-40° to +185°F)
- Humidity: .....95% non-condensing
- Tested in accordance with MIL-STD-810F for:  
low pressure, solar radiation, rain, humidity, salt fog,  
sand & dust, and vibration

#### PERFORMANCE <sup>1</sup>

- Measurement Precision (RMS):  
Raw C/A code: .....20 cm @ 42 dB-Hz  
Raw carrier phase noise: .....L1: 0.95 mm @ 42 dB-Hz  
.....L2: 0.85 mm @ 42 dB-Hz
- Velocity: .....0.01 m/s
- Real-time StarFire Accuracy (RMS):  
Position (H): .....<10 cm  
Position (V): .....<15cm
- Enhanced SBAS (WAAS/EGNOS) Positioning Accuracy:  
Horizontal: .....0.5m  
Vertical: .....0.7m
- Code Differential GPS Positioning <200kms (RMS):  
Horizontal: .....12 cm + 2ppm  
Vertical: .....25 cm + 2ppm

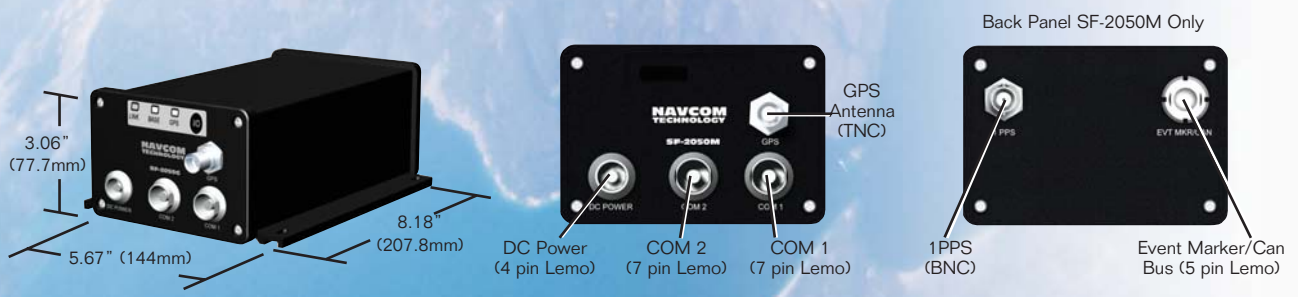
- RTK Positioning <10kms (Software option) (RMS):  
Horizontal: .....1 cm + 1ppm  
Vertical: .....2 cm + 1ppm
- RTK Extend (Software option) (RMS):  
Horizontal: .....2 cm + 1ppm  
Vertical: .....4 cm + 1ppm
- User programmable output rates:  
Position Velocity Time: .....5 Hz (10Hz, 25Hz Optional)  
Raw measurement data: ..5 Hz (10Hz, 25Hz, 50Hz Optional)
- Data Latency:  
Position Velocity Time: .....< 20 ms at all rates  
Raw measurement data: .....< 20 ms at all rates
- Time-to-first-fix:  
Cold Start, Satellite Acquisition: .....< 60 seconds (typical)  
Satellite Reacquisition: .....< 1 second
- Dynamics: (Speed & Altitude restricted by export laws)  
Acceleration: .....up to 6g  
Speed: .....< 1,000 knots (515 m/s)  
Altitude: .....< 60,000 ft (18.3km)
- 1PPS Resolution: .....12.5ns relative accuracy  
(SF-2050M Only)

<sup>1</sup> Performance dependent on location, satellite geometry, atmospheric conditions and GPS corrections.

#### COMMUNICATIONS

- Messages:  
Data/Control: .....NCT Binary Messages  
NMEA: .....ALM, GGA, GLL, GSA, GST, GSV,  
RMC, VTG, ZDA
- Corrections: .....RTCM Code (Msg. 1, 3 & 9)  
SBAS (WAAS/EGNOS)  
StarFire™
- RTK Corrections: .....NCT Proprietary  
(Optional) RTCM (Msg. 18/19 or 20/21)  
CMR (Msg. 0, 1, 2)  
CMR+

www.navcomtech.com



# GPS Pathfinder Pro XRS

## High-performance GPS with a world of real-time options

The versatile GPS Pathfinder® Pro XRS receiver is the thoroughbred of GPS receivers. Offering a full range of accurate real-time correction sources, great performance in all GPS conditions, and rugged design for the toughest environments, the Pro XRS is an essential tool for collecting and maintaining GPS data.

### Built to meet your demands

With the Pro XRS, you don't have to worry whether your GPS receiver can stand up to harsh conditions. All its components are sealed in a robust casing. Waterproof, dustproof, and shock-resistant, the Pro XRS can work anywhere you can.

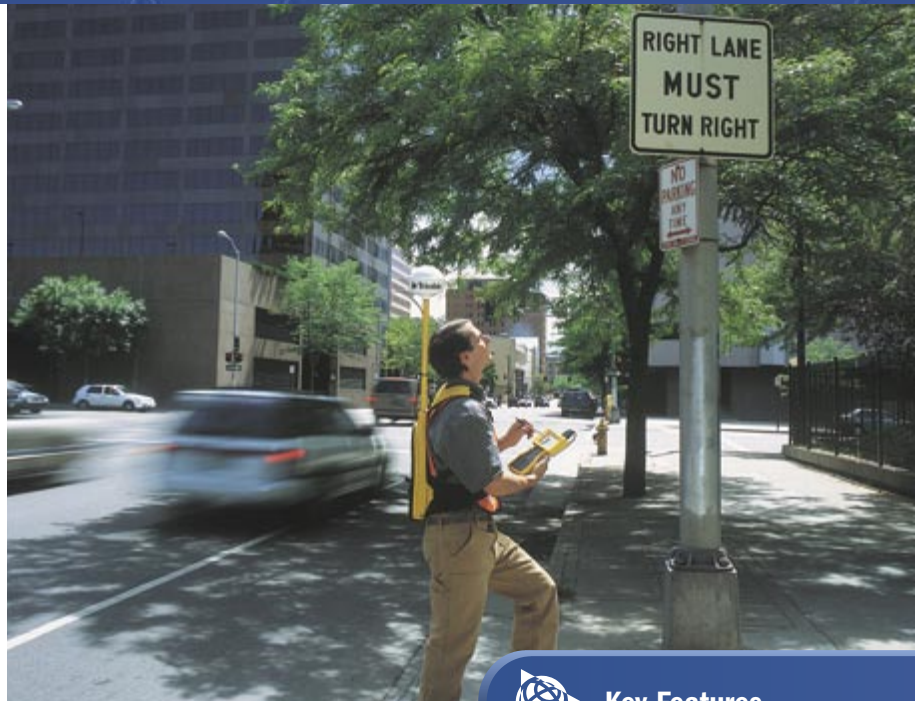
Just as tough is the custom-designed ergonomic backpack. But it's light and comfortable, so you can wear it all day.

### You're spoiled for real-time choice

If you're navigating in the field, or finding your way back to a previously recorded feature, you've got all the real-time options covered. Corrections from a radiobeacon, a satellite differential service such as OmniSTAR, or a satellite-based augmentation system (SBAS) like WAAS<sup>1</sup> or EGNOS<sup>2</sup> are not just built in, they're seamlessly integrated into the receiver. Want the freedom to connect to an external correction source like a virtual reference station (VRS)? You've got it. This array of real-time sources makes the Pro XRS the most adaptable real-time GPS receiver around.

### High quality, accurate data for your GIS

With the Pro XRS, you can be sure that the data you collect meets your high standards. Offering submeter accuracy in real time, and centimeter-level postprocessed accuracy, it's the obvious choice for collecting the high quality GPS data



you need in your GIS. And it has advanced design features, like EVEREST™ multipath rejection technology, to ensure you get only the best positions.

### Get the results you want

The GPS Pathfinder Pro XRS's advanced design gives you complete control over GPS quality. You can focus on productivity, to keep working even in adverse GPS conditions. Or you can configure the receiver to deliver only the most precise positions. It's up to you.

### Flexible data collection options

Pick the field device and software that fits your workflow. The Pro XRS is ready to use with a variety of field computers, including Trimble's own range of handheld computers: the GIS TSCe™ field device, the Trimble® Recon™ handheld, and the GeoExplorer® series.

Choosing software? Try the TerraSync™ software, for a complete solution from the field to the office and back. Choose off-the-shelf GPS field software. Or use the GPS Pathfinder Tools SDK to build your own application that's totally customized to your needs.



## Key Features

- Real-time submeter accuracy
- Integrated satellite, beacon, and WAAS/EGNOS differential receiver
- EVEREST multipath rejection
- Rugged design
- Ergonomic, comfortable backpack system
- Choice of field device and field software

### All you need

You need equipment that's as adaptable and hard-working as you are. So when you're choosing GPS equipment, don't compromise. Get a GPS Pathfinder Pro XRS receiver and have it all.



## Introduction

The GPS Pathfinder Systems receivers calculate very accurate GPS positions on a second-by-second basis. After postprocessed differential correction, the horizontal accuracy of each position for the GPS Pathfinder Pro XR and Pro XRS receivers is better than 50 cm (RMS) + 1 part per million (ppm) times the distance between the base and the rover. For the GPS Pathfinder Power receiver, the horizontal accuracy is submeter (RMS) + 1 ppm. Using real-time corrections, each position can be as accurate as submeter with the GPS Pathfinder Systems, but is subject to a number of operational conditions.

*Note – RMS means that approximately 63% of the positions are within the specified value.*

## Differential GPS Positioning Techniques

Differential GPS (DGPS) requires two or more receivers. One receiver, called the reference station, is located at a known point to determine the GPS measurement errors and compute corrections to these errors. An unlimited number of mobile GPS Pathfinder Systems receivers, commonly called *rovers*, collect GPS data at unknown locations within the vicinity of the reference station. Errors common at both the reference and rover receivers are corrected with DGPS either in real time or during postprocessing.

*Note – For more information about GPS and DGPS, review the All About GPS tutorial on the Trimble website at [www.trimble.com](http://www.trimble.com).*

The GPS Pathfinder Systems receivers, in combination with Trimble controlling software and the GPS Pathfinder Office software, provide three ways of obtaining submeter positions:

- Real-time DGPS
- Postprocessed DGPS
- Postprocessed real-time DGPS

The accuracy figures given in the sections below are obtained under the following conditions:

- Number of satellites used:  $\geq 4$
- PDOP:  $\leq 6$
- Signal-to-noise ratio:  $\geq 4$
- Satellite elevation mask:  $\geq 15^\circ$
- Reference station receiver is a Trimble GPS Pathfinder Pro XL, Pro XR, Pro XRS, 4700, 4800, 5700, 5800, 4600 LS<sup>TM</sup>, Series 4000 GPS receiver, DSM<sup>TM</sup>, Reference Station, or equivalent.
- Synchronized measurements are logged at the reference station.
- The logging interval for the roving receiver is the same as, or a multiple of, the logging interval at the reference station.
- The reference station uses the correct antenna.

## Real-Time DGPS

When using real-time DGPS, the reference station broadcasts the correction values to the rovers within coverage range, through a transmitter such as a radiobeacon (beacon DGPS) or a satellite (satellite DGPS). The rover applies the corrections to its position in real time.

The positions calculated by the GPS Pathfinder Systems receivers using real-time DGPS are of submeter accuracy + 1 ppm. If you use a provider of real-time DGPS that uses VRS/VBS techniques, there is no degradation associated with distance from the reference station, and the accuracy always stays at the submeter level (RMS).

GPS Pathfinder Systems also supports corrections from satellite-based augmentation systems (SBAS) such as WAAS and EGNOS.

For information on postprocessing GPS data collected with real-time DGPS, see Postprocessed real-time DGPS, page 20.

## **Postprocessed DGPS**

When real-time DGPS is not available, or is available only part of the time, you have to postprocess the autonomous GPS data in your rover file to obtain the stated accuracy. When using postprocessed DGPS, the reference station stores the correction values in base data files on a computer.

Many reference station owners provide their base data to the community through the Internet or other means of communication. Often this means that you do not have to set up your own reference station for postprocessed DGPS, but can use an existing one. For a list of available reference stations, visit the Trimble website [www.trimble.com/trs/findtrs.asp](http://www.trimble.com/trs/findtrs.asp).

## **Postprocessed real-time DGPS**

Postprocessed DGPS positions are generally more accurate than DGPS positions obtained in real time. If you collect SuperCorrect records as well as GPS positions using Trimble TerraSync or GPSCorrect™ software, or applications developed using the GPS Pathfinder Tools SDK, you can use the SuperCorrect option in the GPS Pathfinder Office software to process the data if the accuracy of the real-time DGPS positions is not sufficient, provided that you have access to suitable reference station base files.

The accuracy using postprocessed real-time DGPS is the same as for postprocessed DGPS (see the previous section).

## **Factors Affecting Postprocessed DGPS Accuracy**

The accuracy that you obtain after data collection depends on several factors, including:

- Number of visible satellites
- Multipath
- Distance between reference station and rover receivers

- Position Dilution of Precision (PDOP)
- Signal-to-noise ratio (SNR)
- Satellite elevations
- Occupation time at a point
- Receiver type at reference station
- Accuracy of the reference station position
- Synchronized measurements are logged at the reference station.
- The logging interval for the roving receiver is the same as, or a multiple of, the logging interval at the reference station.
- The reference station uses the correct antenna.

## Number of visible satellites

Generally, you need a minimum of four satellites to get a good position. If you have five or more satellites, accuracy increases by a small amount. You can obtain positions from only three satellites by supplying a height value manually. However, Trimble recommends that you do not use this method, as an inaccurate height can significantly reduce horizontal accuracy.

*Note – The TerraSync software always uses a minimum of four satellites. You cannot configure this setting.*

When the number of visible satellites drops below the required number, the controlling software stops logging positions and displays the message *Too few satellites*.

## Multipath

GPS signals are sometimes reflected off nearby objects, particularly metallic objects, creating false or erroneous results. This phenomenon is known as *multipath*. Severe multipath may cause position errors of many meters, while mild multipath may cause small, undetectable errors. For optimal accuracy, collect data in an environment that is free

of large reflective surfaces, such as buildings and trees. EVEREST multipath reduction technology in the receiver helps reduce the effects of multipath.

## **Distance between reference station and rover**

When you postprocess GPS Pathfinder Pro XR and Pro XRS data using the GPS Pathfinder Office software Differential Correction utility, the horizontal accuracy of the positions received is 50 cm (RMS) at a 1 km base line (distance from reference station). For the GPS Power receiver, the horizontal accuracy of the positions received is submeter (RMS) at a 1 km base line.

Accuracy degrades by 1 ppm as the distance between the reference station and the rover increases. This means that 1 mm of degradation occurs for every kilometer between the reference station and the rover. For example, you must collect data within 500 km (310 miles) of your reference station to obtain submeter accuracy for the GPS Pathfinder Pro XR and Pro XRS receiver.

## **PDOP**

PDOP (Position Dilution of Precision) is a unitless measure of the current satellite geometry. It indicates when the most accurate results are provided. When satellites are spread around the sky, the PDOP value is low, and the computed position is more accurate. When the satellites are grouped closely together, the PDOP value is high, and the computed position is less accurate. The lower the PDOP value, the more accurate the GPS positions.

You can configure the PDOP mask so that if the PDOP exceeds the mask value, the controlling software stops logging positions. A PDOP mask of 6 is required for submeter accuracy.

## SNR

SNR (signal-to-noise ratio) is a measure of the satellite signal strength relative to the background noise. A strong signal with low noise provides better accuracy. You can raise the SNR mask so that weak signals with an SNR below the mask are excluded from the position computation. In areas of dense canopy, the SNR mask can be lowered so that you can collect GPS positions, although you may not achieve submeter accuracy. For best results, the recommended setting for the SNR mask is 4.

## Elevation mask

When a satellite is low on the horizon, the GPS signals must travel further through the atmosphere, delaying reception by the receiver. To minimize noisy data, adjust the elevation mask. Satellites below the mask are excluded from the position computation. For best results, the recommended setting is  $15^{\circ}$ .

## Occupation period

The GPS Pathfinder Systems receivers achieve the specified horizontal accuracy with a one-second occupation time.

*Note – To achieve higher levels of accuracy using a GPS Pathfinder Systems receiver, collect carrier-phase data and postprocess using the GPS Pathfinder Office software.*

## Receiver type

The following Trimble receiver models use Maxwell™ technology and, when used as the reference station, yield submeter accuracy with GPS Pathfinder Systems receivers:

- GPS Pathfinder Pro XRS
- GPS Pathfinder Pro XR
- GPS Pathfinder Pro XL



- 5800 GPS receiver
- 5700 GPS receiver
- 4800 GPS receiver
- 4700 GPS receiver
- 4600 LS Surveyor
- 4000 series receiver
- DSM Reference Station



---

**Warning** – If the GPS receiver at the reference station has fewer than 12 channels, you may be unable to differentially correct some of your data. If the reference station is not capable of logging data from all of the satellites the rover is using, the data collected by the rover cannot be differentially corrected using postprocessing.

---

## Accuracy of the reference station position

Any inaccuracy in the reference station position is reflected in your rover position accuracy. For information on the accuracy of your local DGPS reference station coordinates, contact the provider of that service, and check the Integrity Index in the GPS Pathfinder Office version 3.00 Differential Correction utility when selecting a new base station provider.

The Integrity Index provides you with an indication as to the quality of available base data in comparison to other available sources. Poor base data can result from a number of factors, such as an incorrect reference position, bad environmental location, or a large distance between the base and rover receivers. Base data downloaded from each station is analyzed to formulate the quality indicator values and three key measures are taken into account:

- Bias (the measure of distance between an averaged GPS position and a specified reference position)
- Precision (the measure of the spread of actual GPS positions)
- The distance between the base and rover receivers

Use the Integrity Index to avoid selecting base data that may provide an inferior differential correction result. The quality indicator has a range of 0 to 100, where 0 represents low quality base data and 100 represents high quality base data. For more information, refer to the GPS Pathfinder Office 3.00 Differential Correction Help.

## Synchronized measurements

To obtain optimal accuracy from differential correction, the reference station must record reference data (or output differential corrections) from synchronized measurements. Synchronized measurements occur when the reference station receiver and rover receivers simultaneously make measurements to all the satellites they are tracking.

When you use one of the receivers listed in Receiver type, page 23, as a reference station receiver, the data is always synchronized. When measurements are not synchronized, there is no equivalent reference station position measured at exactly the same time as the rover position. A simultaneous reference station position must be interpolated, which reduces accuracy.

## Logging intervals

Ideally, the logging interval at the reference station should be the same as the logging interval at the rover. For example, if the reference station is using a 5-second logging interval, the rover logging interval should be 5 seconds. The rover logging interval can also be a direct integer multiple of the interval at the reference station. For example, if the reference station is logging every 5 seconds, the rover can log every 10 seconds.

If the rover logging interval is not synchronized with the reference station, the accuracy of the GPS positions logged by the rover may not be submeter. This is because the reference station measurements must be interpolated to correct the roving receiver's measurements. For more information, see Synchronized measurements, page 25.

If the synchronized measurement logging interval at the reference is 1 second, you can use any logging interval at the rover. However, this generates a large file at the reference station. If the computer or data collector at the reference station runs out of space, you cannot differentially correct any rover data collected after the base file ends.

When disk space is at a premium, the best option is a 5-second logging interval for synchronized measurement data at the reference station and a 5-second logging interval for positions at the rover. This is frequent enough to be practical at the rover and uses the default reference station logging interval, which results in base files that are not too large.

Table 3.1 gives examples of various reference station and rover intervals and their effect on accuracy. They are valid for both postprocessed and real-time corrections.

**Table 3.1 Logging Interval Accuracy**

Reference station interval (seconds)	Rover interval (seconds)	Base data interpolated?	Notes
1	1	No	Recommended for best accuracy.
5	5	No	Recommended if reference station disk space is at a premium.
1	3, or 5, or 6, etc.	No	The rover interval is a direct integer multiple of the reference station interval.
5	10	No	The rover interval is a direct integer multiple of the reference station interval.
5	1	Yes	Base data is interpolated at seconds 1, 2, 3, and 4. A slight degradation of accuracy occurs with interpolation. One in five of the rover positions is not interpolated.

## Factors Affecting Real-Time DGPS Accuracy

Real-time DGPS offers similar accuracies to postprocessed GPS. However, in addition to the factors discussed in Factors Affecting Postprocessed DGPS Accuracy, page 20, there are other factors that affect the accuracy of real-time DGPS positions. These factors include:

- Update rate of the corrections
- Corrections based on a different datum

### Update rate of the corrections

The frequency, or rate, at which the RTCM differential correction messages are output from the reference station affects the accuracy of the GPS positions recorded by the roving receiver. The latency of the corrections (that is, the time it takes for up-to-date information to get from the reference station to the rover) also affects the rover position accuracy.

### Datum of corrections

Errors can occur if the reference stations use a datum other than WGS-84 as the basis for the DGPS corrections. The error introduced by using a reference station that transmits coordinates using a different datum is generally quite small. However, in some places the margin of error can be 5–10 meters. To avoid this type of error, set Trimble controlling software to collect SuperCorrect data. You can then postprocess the real-time DGPS positions if required.

# GPS Pathfinder Pro XRS

## High-performance GPS with a world of real-time options

The versatile GPS Pathfinder® Pro XRS receiver is the thoroughbred of GPS receivers. Offering a full range of accurate real-time correction sources, great performance in all GPS conditions, and rugged design for the toughest environments, the Pro XRS is an essential tool for collecting and maintaining GPS data.

### Built to meet your demands

With the Pro XRS, you don't have to worry whether your GPS receiver can stand up to harsh conditions. All its components are sealed in a robust casing. Waterproof, dustproof, and shock-resistant, the Pro XRS can work anywhere you can.

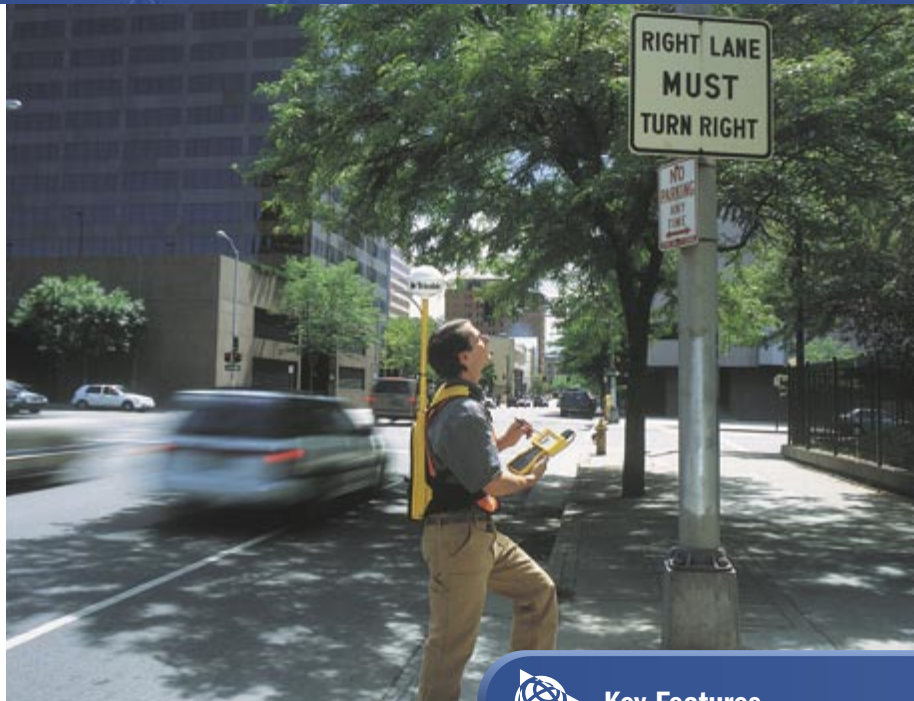
Just as tough is the custom-designed ergonomic backpack. But it's light and comfortable, so you can wear it all day.

### You're spoiled for real-time choice

If you're navigating in the field, or finding your way back to a previously recorded feature, you've got all the real-time options covered. Corrections from a radiobeacon, a satellite differential service such as OmniSTAR, or a satellite-based augmentation system (SBAS) like WAAS<sup>1</sup> or EGNOS<sup>2</sup> are not just built in, they're seamlessly integrated into the receiver. Want the freedom to connect to an external correction source like a virtual reference station (VRS)? You've got it. This array of real-time sources makes the Pro XRS the most adaptable real-time GPS receiver around.

### High quality, accurate data for your GIS

With the Pro XRS, you can be sure that the data you collect meets your high standards. Offering submeter accuracy in real time, and centimeter-level postprocessed accuracy, it's the obvious choice for collecting the high quality GPS data



you need in your GIS. And it has advanced design features, like EVEREST™ multipath rejection technology, to ensure you get only the best positions.

### Get the results you want

The GPS Pathfinder Pro XRS's advanced design gives you complete control over GPS quality. You can focus on productivity, to keep working even in adverse GPS conditions. Or you can configure the receiver to deliver only the most precise positions. It's up to you.

### Flexible data collection options

Pick the field device and software that fits your workflow. The Pro XRS is ready to use with a variety of field computers, including Trimble's own range of handheld computers: the GIS TSCe™ field device, the Trimble® Recon™ handheld, and the GeoExplorer® series.

Choosing software? Try the TerraSync™ software, for a complete solution from the field to the office and back. Choose off-the-shelf GPS field software. Or use the GPS Pathfinder Tools SDK to build your own application that's totally customized to your needs.



## Key Features

- Real-time submeter accuracy
- Integrated satellite, beacon, and WAAS/EGNOS differential receiver
- EVEREST multipath rejection
- Rugged design
- Ergonomic, comfortable backpack system
- Choice of field device and field software

### All you need

You need equipment that's as adaptable and hard-working as you are. So when you're choosing GPS equipment, don't compromise. Get a GPS Pathfinder Pro XRS receiver and have it all.



## What Can the GPS Pathfinder Systems Receivers Do?

The GPS Pathfinder Systems receivers, with Trimble controlling software, make an ideal system for all GIS data collection and maintenance projects. The system allows you to collect precise data for utility, urban, and natural resource databases. As the demand for accurate and up-to-date position and attribute information increases, the system allows you to update existing GIS data, ensuring that decisions made with the GIS are based upon the most accurate, current, and reliable data available.

The foundation of the GPS Pathfinder Systems receivers is precise GPS positioning technology. The GPS receivers feature 12 parallel channels for continuous satellite tracking. Using differential GPS, the GPS Pathfinder Systems receivers deliver differentially corrected C/A code positions to submeter accuracy on a second-by-second basis under the most challenging operating conditions.

### **Integrated Satellite Based Augmentation System (SBAS) receiver**

Satellite Based Augmentation System (SBAS) support is integrated into the GPS Pathfinder Pro XR, Pro XRS, and Power receiver. It allows you free access to real-time solutions transmitted from geostationary SBAS satellites, such as the Wide Area Augmentation System (WAAS) in the United States and the European Geostationary Navigation Overlay Service (EGNOS) in Europe.

### **Integrated beacon receiver**

The MSK beacon receiver is included in the GPS Pathfinder Pro XR and Pro XRS receivers. It allows you free access to real-time solutions transmitted from DGPS radiobeacons operating in the MF (medium frequency) band from 283.5 kHz to 325 kHz. The integrated MSK beacon receiver is an advanced dual-channel radiobeacon receiver. It

tracks broadcasts from DGPS radiobeacons conforming to the IALA Standard. The beacon receiver uses its *all-digital signal processing* techniques to track and demodulate signals from DGPS radiobeacons.

For an up-to-date list of beacon stations, visit the following Web page:

- [www.trimble.com/findbeacon.asp](http://www.trimble.com/findbeacon.asp)

## **Integrated satellite differential receiver**

The integrated satellite differential capability of the GPS Pathfinder Pro XRS and Power receivers decodes and uses satellite differential corrections to provide submeter position accuracy. To receive and decode these satellite signals, you must subscribe to a satellite differential correction service. The GPS Pathfinder Pro XRS and Power receivers support the OmniSTAR satellite differential correction services. For information on obtaining a subscription, subscription rates, and satellite coverage maps, visit [www.omnistar.com](http://www.omnistar.com)

Once you have a subscription, you activate the service through an on-the-air signal or an encrypted activation message entered into the controlling software.

Satellite differential signals provide valid corrections over a large area. Integrated virtual reference/base station (VRS/VBS) technology permits the satellite corrections to be uniformly accurate over the entire satellite coverage area, without the degradation in accuracy associated with increasing distance from fixed reference stations.

Satellite differential signals are line-of-sight and can be blocked by mountains, buildings, or tree canopy. Wet canopy, from a heavy rain, reduces the signals even more. The same environmental factors that affect the GPS signal, such as radar and microwave transmitters, can interfere with the satellite signal. Power lines usually have no effect.

## External differential correction receiver

The GPS Pathfinder Systems receivers can also receive differential corrections from any external differential correction receiver that communicates in the standard RTCM SC-104 data format.

## Standard GPS Pathfinder Pro XR and Pro XRS Features

The GPS Pathfinder Pro XR and Pro XRS receivers offer the following:

- 12-channel DGPS receiver with EVEREST™ multipath rejection technology, L1 C/A code tracking with carrier-phase smoothing, and instantaneous full-wavelength carrier-phase measurements.
- Submeter accuracy – Typically horizontal accuracy less than 50 cm RMS with GPS Pathfinder Office software postprocessing. This requires data to be collected with a minimum of 4 satellites, maximum PDOP of 6, minimum SNR of 4, minimum elevation of 15 degrees, and reasonable multipath conditions.
- Integrated WAAS/EGNOS differential corrections
- 1 Hz position and velocity update rate.
- Velocity computations incorporate carrier-phase data.
- Time to First Fix typically less than 30 seconds.
- Two RS-232 serial ports.
- NMEA-0183 output to external NMEA devices (supported messages are ALM, GGA, GLL, GSA, GSV, VTG, and ZDA).
- RTCM-SC 104 input from an external differential correction receiver.
- TSIP protocol to/from the field device.
- Fully automatic and manual beacon operating modes, fast acquisition of differential beacon signals.



- Immunity to MSK jamming signals, advanced techniques for combating atmospheric noise in the beacon receiver.
- Integrated GPS/MSK beacon antenna.
- User-upgradeable receiver firmware.
- Receiver manual.
- CE Mark compliance.

### **Additional GPS Pathfinder Pro XRS receiver features**

The GPS Pathfinder Pro XRS GPS/MSK/beacon/satellite differential receiver offers the items previously listed, and also:

- Integrated L-band satellite differential correction receiver
- Combined L1 GPS/beacon/satellite differential antenna

## Combined L1 GPS/beacon/satellite differential antenna

The GPS Pathfinder Pro XRS receiver integrated L1 GPS/beacon/satellite differential antenna (P/N 33580-50) features two antenna components:

- **L1 GPS/satellite differential antenna**  
This active antenna is designed to filter out unwanted signals and amplify the L1 GPS and satellite differential signals for transmission over the antenna cable to the receiver.
- **MSK H-field loop beacon antenna**  
This antenna features a pre-amplifier for filtering out signal interference such as AM radio broadcasts and noise from switching power supplies. After filtering, the pre-amplifier amplifies the MF signal for transmission over the same antenna cable to the beacon receiver.

The coaxial antenna cable also carries DC power to the pre-amplifier of both the L1 GPS/satellite differential and beacon antennas over the center conductor of the cable.

The antenna assembly integrates the L1 GPS/satellite differential antenna and a beacon antenna into a single antenna assembly, as shown in Figure 2.2. The antenna assembly is completely weatherproof and is designed to withstand harsh environmental conditions.



Figure 2.2 Combined L1 GPS/beacon/satellite differential antenna (for the GPS Pathfinder Pro XRS receiver)

## Introduction

This appendix lists specifications for GPS Pathfinder Systems receivers and antennas, and pinouts for cables that are supplied with the receivers.

## Specifications

Table B.1 lists specifications for the GPS Pathfinder Pro XR and Pro XRS receiver.

**Table B.1 GPS Pathfinder Pro XR and Pro XRS receiver specifications**

Parameter	Specification
General	12 channel, L1/CA code tracking with carrier phase filtered measurements and multibit digitizer
Update Rate	1 Hz
Time to First Fix	< 30 seconds, typical
Size	11.1 cm × 5.1 cm × 19.5 cm (4.4" × 2.0" × 7.7")
Weight	0.76 kg (1.68 lb)
Power	XR 6 W (maximum) XRS 7 W (maximum) both 10 to 32 VDC
Temperature	-20 °C to 65 °C (-4 °F to 149 °F) operating -30 °C to 85 °C (-22 °F to 185 °F) storage
Humidity	100% non-condensing
Casing	Dustproof, splashproof, shock-resistant, sealed to 5psi

Table B.3 lists specifications for the GPS Pathfinder Pro XRS antenna.

**Table B.3 Combined L1 GPS/beacon/satellite differential antenna specifications**

<b>Parameter</b>	<b>Specification</b>
General	Right-hand, circular polarized; omnidirectional; hemispherical coverage
Size	15.5 cm diameter × 14 cm high (6.1" × 5.5")
Weight	0.55 kg (1.2 lb)
Temperature	-20 °C to 65 °C (-4 °F to 149 °F) operating -40 °C to 85 °C (-40 °F to 185 °F) storage
Humidity	100% fully sealed
Casing	Dustproof, waterproof, shock resistant

## Pinouts

Table B.5 lists the pinouts for the GPS Pathfinder Pro XR and Pro XRS receiver's data/power cable.

**Table B.5 Data/power cable pinout (P/N 30231-00)**

To GPS Pathfinder Pro XR and Pro XRS receiver			Field Device	Input Power		
Conn P1	7 Cond Cbl #1		Conn P2 DE9-F	2 Conn Cbl #2	Conn P3 TA3-M	
Event In	1	in —	—	—	—	—
TXD out	2	Orange	2 RXD	—	—	—
RXD	3	in Red	3 TXD	—	—	—
Chg Ctrl	4	in Black	4 DTR	—	—	—
Sig Gnd in/out	5	Shield	5 Sig Gnd	—	—	—
DSR out	6	Yellow	6 DSR	—	—	—
Pwr On	7	in Brown	7 RTS	—	—	—
CTS out	8	Green	8 CTS	—	—	—
Charge out	9	Blue	9 RI	—	—	—
V+ In	10	in —	—	White	1	V+ In
V- In	11	in —	—	Black	2	V- Out
PPS —	12	—	—	—	—	—

Table B.7 lists the pinouts for the GPS Pathfinder Pro XR and Pro XRS receiver's NMEA/RTCM cable.

**Table B.7 NMEA/RTCM cable pinout (P/N30232-00)**

To GPS Pathfinder Pro XR and Pro XRS receiver			NMEA/RTCM output connectors		
Conn P1		9 Cond Cbl #1	Conn P2 DE9-M	7 Conn Cbl #1	Conn P3 DE9-F
Event In	1 in	—	—	—	—
TX- (232)	2 out	—	—	Orange	2 TXD
RX- (232)	3 in	Red	2 RXD	—	—
Chg Ctrl	4 in	—	—	Shield	—
Sig Gnd	5 in/out	Shield	5 Sig Gnd	—	5 Sig Gnd
TX+ (422)	6 out	—	—	—	—
Pwr On	7 in	—	—	—	—
RX+ (422)	8 out	—	—	—	—
Charge	9 out	Yellow	9 Pwr	—	—
V+ In	10 in	—	—	—	—
V- In	11 in	—	—	—	—
PPS	12 —	—	—	Brown	4 DTR

# GPS Pathfinder Pro XRS

## High-performance GPS with a world of real-time options

The versatile GPS Pathfinder® Pro XRS receiver is the thoroughbred of GPS receivers. Offering a full range of accurate real-time correction sources, great performance in all GPS conditions, and rugged design for the toughest environments, the Pro XRS is an essential tool for collecting and maintaining GPS data.

### Built to meet your demands

With the Pro XRS, you don't have to worry whether your GPS receiver can stand up to harsh conditions. All its components are sealed in a robust casing. Waterproof, dustproof, and shock-resistant, the Pro XRS can work anywhere you can.

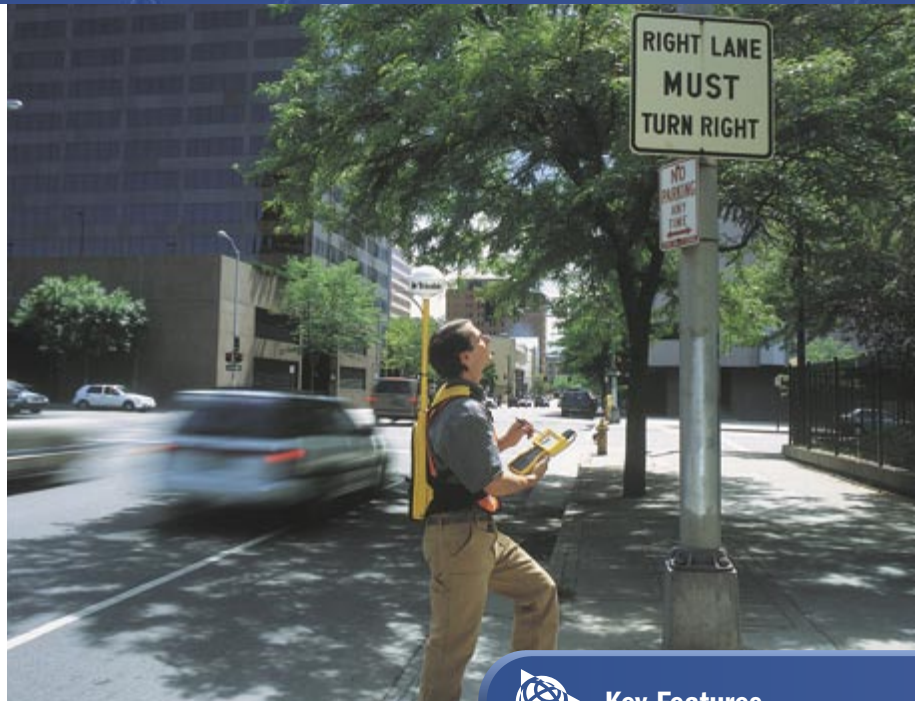
Just as tough is the custom-designed ergonomic backpack. But it's light and comfortable, so you can wear it all day.

### You're spoiled for real-time choice

If you're navigating in the field, or finding your way back to a previously recorded feature, you've got all the real-time options covered. Corrections from a radiobeacon, a satellite differential service such as OmniSTAR, or a satellite-based augmentation system (SBAS) like WAAS<sup>1</sup> or EGNOS<sup>2</sup> are not just built in, they're seamlessly integrated into the receiver. Want the freedom to connect to an external correction source like a virtual reference station (VRS)? You've got it. This array of real-time sources makes the Pro XRS the most adaptable real-time GPS receiver around.

### High quality, accurate data for your GIS

With the Pro XRS, you can be sure that the data you collect meets your high standards. Offering submeter accuracy in real time, and centimeter-level postprocessed accuracy, it's the obvious choice for collecting the high quality GPS data



you need in your GIS. And it has advanced design features, like EVEREST™ multipath rejection technology, to ensure you get only the best positions.

### Get the results you want

The GPS Pathfinder Pro XRS's advanced design gives you complete control over GPS quality. You can focus on productivity, to keep working even in adverse GPS conditions. Or you can configure the receiver to deliver only the most precise positions. It's up to you.

### Flexible data collection options

Pick the field device and software that fits your workflow. The Pro XRS is ready to use with a variety of field computers, including Trimble's own range of handheld computers: the GIS TSCe™ field device, the Trimble® Recon™ handheld, and the GeoExplorer® series.

Choosing software? Try the TerraSync™ software, for a complete solution from the field to the office and back. Choose off-the-shelf GPS field software. Or use the GPS Pathfinder Tools SDK to build your own application that's totally customized to your needs.



## Key Features

- Real-time submeter accuracy
- Integrated satellite, beacon, and WAAS/EGNOS differential receiver
- EVEREST multipath rejection
- Rugged design
- Ergonomic, comfortable backpack system
- Choice of field device and field software

### All you need

You need equipment that's as adaptable and hard-working as you are. So when you're choosing GPS equipment, don't compromise. Get a GPS Pathfinder Pro XRS receiver and have it all.



## Reference Materials

If you have a problem and cannot find the information you need in the product documentation, *contact your local Distributor*. Alternatively, go to the Trimble Support page at [www.trimble.com/support.html](http://www.trimble.com/support.html), and then do one of the following:

- Browse the available online support resources.
- Request technical assistance from Trimble Support, click the submit an inquiry link, fill in the form, and then click **Send**.

Trimble: [www.trimble.com/support.html](http://www.trimble.com/support.html)

Survey Controller: [www.trimble.com/tsce.html](http://www.trimble.com/tsce.html)

Survey Pro: [www.tdsurvey.com](http://www.tdsurvey.com)

GIS TSCe: [www.trimble.com/gistsce.html](http://www.trimble.com/gistsce.html)

ActiveSync™: [www.microsoft.com/windowsmobile/  
resources/downloads/pocketpc/default.aspx](http://www.microsoft.com/windowsmobile/resources/downloads/pocketpc/default.aspx)

Windows CE: [www.microsoft.com/windows/embedded/ce.net](http://www.microsoft.com/windows/embedded/ce.net)

## Hardware Specifications

Feature	TSCe
<i>Processor</i>	Intel StrongARM SA-1110, 206 MHz
<i>Memory</i>	64 MB low-power SDRAM
<i>Storage</i>	512 MB non-volatile flash disk
<i>Screen</i>	1/4 VGA transfective color LCD
<i>Touch Screen</i>	Passive - 87% transmissivity
<i>Keyboard</i>	57 key tactile action
<i>9-Pin serial port</i>	RS232 COM1
<i>26-Pin MultiPort</i>	RS232 COM2, Ethernet 10BaseT, USB client, power in/out and audio in/out
<i>Infrared</i>	IrDA Type1 COM3
<i>Audio</i>	Integrated speaker and microphone
<i>Batteries</i>	NiMH rechargeable pack, 3800 mAh, 18.5 W-h, 4.8 V
<i>AC Adaptor</i>	Line voltage: 100 - 240 V AC 47-63 Hz



SPECIFICATIONS FOR LASER TECH TRUPULSE 200 LASER RANGEFINDER

<b>Dimensions</b>	5" x 2" x 3.5" (12cm x 5cm x 9cm)
<b>Weight</b>	8 ounces (220 g)
<b>Data Communication</b>	Serial, via wired RS232 (standard)
<b>Power</b>	3.0 volts DC nominal
Battery Type	(2) AA or (1) CRV3
Battery Duration	AA: Approximately 7,500 measurements CRV3: Approximately 15,000 measurements
<b>Eye Safety</b>	FDA Class 1 (CFR 21)
<b>Environmental</b>	Impact, Water & Dust Resistant. NEMA 3, IP 64
<b>Temperature</b>	-4°F to +140°F (-20°C to +60°C)
<b>Optics</b>	7X Magnification (Field-of-view; 330 ft @ 1000 yards)
<b>Display</b>	In-scope LCD
<b>Units</b>	Feet, Yards, Meters, and Degrees
<b>Monopod/tripod mount</b>	¼ " - 20 female thread
<b>Measurement Range</b>	
Distance	0 to 3280 ft (1000 m) typical, 6560 ft (2000m) max to reflective target
Inclination	± 90 degrees
<b>Accuracy</b>	
Distance	±1 ft (± 30 cm) to high quality targets, ±1 yd (±1 m) to low quality targets
Inclination	±0.25 degrees
<b>Measurement Modes</b>	Horizontal Distance, Vertical Distance, Slope Distance and Inclination, and 3-point flexible height routine with auto sequencing
<b>Target Modes</b>	Standard, Closest, Farthest, Continuous, and Filter (requires reflector and foliage filter)



# IMPULSE 200 LR LASER

Our Impulse lasers are specifically designed for optimal performance under whatever conditions you might encounter in the field. They are lightweight, extremely rugged, completely waterproof and versatile. Use them as a handheld unit or mount them on a tripod for added stability.

## Hardware Specifications:

Typical Target Accuracy & Range	IMPULSE 200 LR	
	(Imperial)	(Metric)
Accuracy (Typical)	0.1 - 0.2 ft	3 - 5 cm
Accuracy (Max)	0.5 ft	15 cm
Overhead cable / Stake	330 ft	100 m
Phone pole / Stockpile	655 ft	200 m
Tree / Tower	985 ft	300 m
Rock Face / Building	1640 ft	500 m
Max Distance	1885 ft	575 m
Range Resolution	.01 ft	0.01 m
Inclination Limits	+/- 90 deg	+/- 90 deg
Inclination Accuracy	+/- 0.1 deg	+/- 0.1 deg
Weight	2.2 lbs.	1 kg
Size	6 x 2.5 x 5 in.	15.2 x 6.4 x 12.7 cm
Power Supply	(2) AA batteries (20 hours of use)	
Environment	Waterproof to IP 67 and NEMA 6	
Temperature	- 22 to + 140 F	-30 to + 60 C

(Max distances are approximate)

## Key Features:

- Custom backlit LCD display
- Audible and visual indicators
- RS232 serial output for electronic data storage
- Selective range gating for positive target acquisition
- Built-in tilt sensor
- Filter system to discriminate reflective targets
- Cumulative distance capability
- Determines the distance between two in-line objects
- Integrates with GPS

## Package Includes:

- Impulse laser
- Red-dot scope
- Hand strap
- Tripod / monopod mounting bracket
- (2) AA batteries
- Operator's manual
- Padded carrying case

## Optional Accessories:

- 1.5 to 4 X zoom scope
- Yoke and staff
- Remote trigger data cable

Impulse Laser w/  
1.5 to 4 X Zoom Scope  
and Mounting Bracket



For 3-D data collection,  
integrate the Impulse with  
a MapStar System.



MapStar  
Angle  
Encoder



MapStar  
Compass  
Module

Impulse Laser w/  
Red-dot Scope  
and Hand Strap



**MVP200  
OPERATION AND MAINTENANCE  
MANUAL**



**BROOKE OCEAN TECHNOLOGY LIMITED**

50 Thornhill Drive  
Dartmouth, Nova Scotia  
Canada B3B 1S1

Phone: (902) 468-2928

Fax: (902) 468-1388

e-mail: [sales@brooke-ocean.com](mailto:sales@brooke-ocean.com)

[www.brooke-ocean.com](http://www.brooke-ocean.com)

## 1 SYSTEM DESCRIPTION

The MVP200 system is a self-contained profiling system capable of sampling water column profiles to 200m depth from a vessel moving at up to 12 knots, and deeper depths at slower speeds. The system provides vertical profiles of oceanographic data such as Sound Velocity, CTD, particle counts, etc. for various operations including the calibration of multi-beam sounder systems for hydrographic operations. The MVP200 is completely autonomous and can be controlled by computer without the requirement for personnel on deck. The system consists of a single or multi-sensor free-fall fish (fish), an integrated winch and hydraulic power unit, towing boom and a remotely located user interface controller. The MVP200 system is shown in Figure 1. The system block diagram is shown in Figure 2.

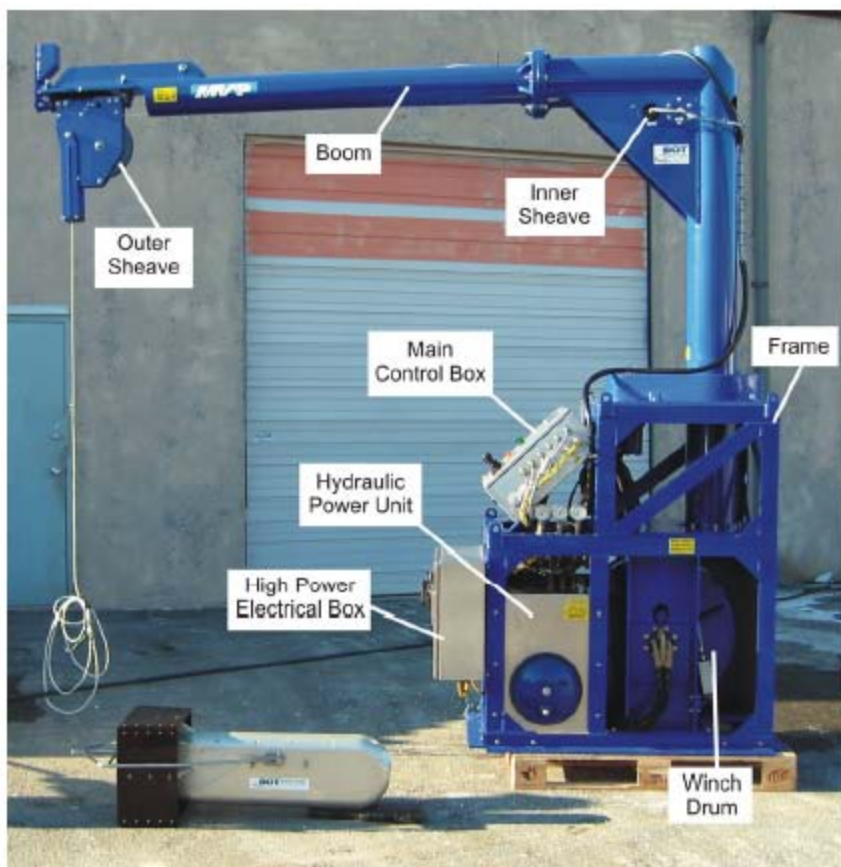


Figure 1: MVP200

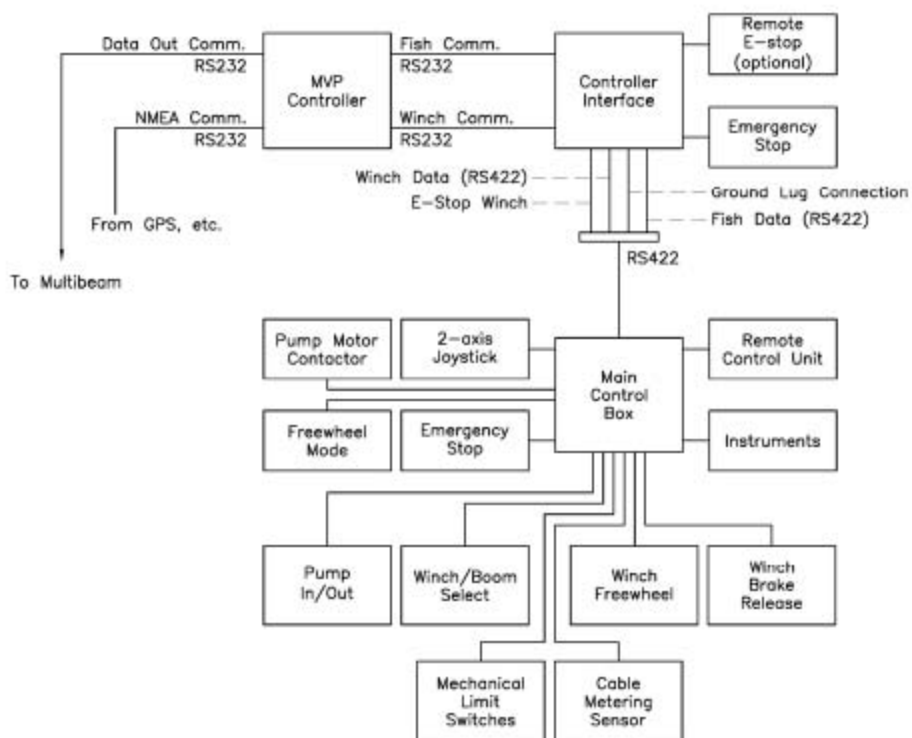


Figure 2: System Block Diagram

Upon actuation, the system deploys the fish from a towed position by setting the winch in 'freewheel' mode and releasing the brake. This allows the fish to free-fall almost straight down through the water at its terminal velocity of approximately 3 m/s. Once the (pre-set) depth limit is reached, the brake is applied to stop the cable pay-out. When the winch drum has stopped, the motor is engaged to haul in the cable until the fish is towed at the surface. Subsequent deployments occur from this position, either actuated by the operator or timed automatically with the automatic deployment setting.

The system operates in the automatic mode described above or in manual mode operated from controls at the winch. Manual mode is used as a convenient method to launch and recover the fish, but is not intended for moving vessel profiling.

## 1.1 FREE-FALL FISH

The free-fall fish can be either a single sensor or a multi sensor fish. The fish houses the main instrument, either a CTD or SV&P sensor. The instrument is normally configured for RS-485 serial communications.

The multi-sensor fish can support auxiliary sensors in addition to the main CTD/SV&P instrument. If auxiliary sensors are used, a DTM/Mux is required in the fish. The DTM/Mux is a data telemetry module with additional digitization and multiplexing circuitry. This allows data from various analog and digital sensors to be added to the main instrument's serial output stream, which is transmitted to the surface.

### 1.1.1 Single-Sensor Free-Fall Fish

The Single Sensor Free-Fall Fish (SSFFF) (see Figure 3) is machined from brass with a stainless steel towing bridle. The sensor guard at the tail of the fish is made from stainless steel. The shape of the fish allows minimal resistance while providing stability during free-fall and retrieval. The fish can be fitted with an Applied Microsystems Ltd. (AML) Sound Velocity and Pressure (SV&P) Smart Sensor or an AML CTD Micro Sensor. (A small plastic support is built into the sensor guard for use with the sound velocity sensor). An impulse underwater connector allows the fish to be removed easily from the electromechanical cable.

The AML CTD Micro Sensor measures conductivity, temperature and pressure. The AML SV&P Smart Sensor measures sound velocity and pressure. The information is sent through the Electro-Mechanical cable to the main control box, through the deck cable to the Instrument Interface box where it then connects to the MVP Controller. If the sensor is a CTD, software in MVP Controller then computes sound velocity and salinity from the measured parameters using the UNESCO equations of state.



Figure 3: Single Sensor Free-Fall Fish

### 3 SPECIFICATIONS

#### 3.1 OPERATING DEPTH

- 600 m @ 0 knots\*
- 350 m @ 5 knots
- 200 m @ 12 knots

\* Ensure sensor(s) are rated for this depth before operations

#### 3.2 WINCH AND HYDRAULIC POWER UNIT

- Drum dimensions: 324 mm (12.7") barrel diameter  
99 mm (3.9") wide  
711 mm (28.0") flange OD
- Line Pull: Bare Drum - 410 kg (900 lbs.)
- Capacity: 660 m (2132 ft) of 6.0 mm (0.24") cable
- Cable: Jacketed Electro-Mechanical , 4 conductor,  
1089 kg (2400 lbs.) maximum break strength
- Hydraulic Winch Motor: Valmet Black Bruin # 403 040 2120
- Rotator Motor: White # 700540C8540ALAAA
- Slip Ring: Focal Technologies Model 180 ESR
- Hydraulic Pump: Rexroth #AA10VG18EP21/10R-NSC66-F004S
- Reservoir: 40 litre Stainless Steel Reservoir
- Maximum operating pressure: 3000 psi (207 Bar)
- Electric motor: 15 hp TEFC 230/460VAC 60 Hz, 208/416VAC 50 Hz, 3-phase
- Suction line filter: LHA Element #SPE-15-BTA-10
- Footprint: 1.22m x 0.71m (48" x 28") excluding boom
- Height: 3.18m (125")
- Approximate Weight: 680 kg (1500 lbs.)

#### 3.3 FREE-FALL FISH

##### 3.3.1 Single Sensor Free-Fall Fish

- Weight: 32 kg (72 lbs.) with sensor, in air
- Body Length: 673 mm (26.5") excluding bridle
- Body Diameter: 114 mm (4.5")
- Sensors: - AML Sound Velocity and Pressure (SV&P) "Smart Sensor", or  
- AML SVP&T Micro Sensor  
- AML CTD Micro Sensor

##### 3.3.2 Multi-Sensor Free-Fall Fish

- Weight: 88.5 kg (195 lbs.) with sensor, in air
- Body Length: 1041 mm (41") excluding bridle
- Body Section: 147 mm x 279 mm (5.8" x 11.0")

- Sensors:
- AML Sound Velocity and pressure (SV&P) "Smart Sensor"
  - AML CTD Micro Sensor
  - AML Dissolved Oxygen (DO) Sensor
  - Wet Labs fluorometers (Wet star, FLF300, and ECO)
  - Satlantic OCR-500 series digital optical sensors
  - Brooke Ocean Technology Ltd. - Laser Optical Plankton Counter (LOPC)

### 3.4 MVP CONTROLLER

*Minimum requirements (refer to system factory configuration for details)*

- Operating system: Windows 2000 Professional
- Processor: Pentium 600 or higher
- Ram: 128 Mb
- Hard Disk: 5 GB Hard drive
- Video: 1024x768 SVGA with 64 thousand colors
- Pointing Device: Microsoft Wheel Mouse
- Serial ports: 4 serial (RS232) ports
- Drive: CD-ROM drive and a 1.44 Mb Floppy drive
- Monitor: 15" Video Monitor
- Keyboard: PS/2 Keyboard
- Hardware: Network Card

### 3.5 POWER REQUIREMENTS

*Winch Power Ratings:*

- Vessel circuit breaker value 90A at 230v and 45A at 460v, maximum setting
- Voltage: 3-phase, 4-wire
  - 230/460V  $\pm 10\%$ , 34/17A at 60 Hz or
  - 208/416V  $\pm 10\%$ , 42/21A at 50 Hz

(Note that system supply voltage must be selected at time of order. It is not a field configurable item)

- 50A main disconnect, circuit breaker
- 15 HP Motor, dual frequency rating with 110V anti-condensation heater
- Motor contactor with thermal overload.
- Includes internal 110V auxiliary distribution: 7A/120V/840W

*MVP Controller (Lab Computer) Power Ratings:*

- Voltage: 1-phase, 100-230 VAC
- Current: 5-8A
- Frequency: 50 or 60 Hz





The SBE 45 MicroTSG Thermosalinograph is an externally powered, high-accuracy instrument, designed for shipboard determination of sea surface (pumped-water) conductivity and temperature. Salinity and sound velocity can also be computed. The MicroTSG is constructed of plastic and titanium to ensure long life with minimum maintenance.

### OPERATION OVERVIEW

Communication with the MicroTSG is over an internal, 3-wire, RS-232C link, providing real-time data transmission. Commands can be sent to the MicroTSG to provide status display, data acquisition setup, data display and capture, and diagnostic tests. User-selectable operating modes include:

- **Polled sampling** – On command, the MicroTSG takes one sample and sends the data to the computer.
- **Autonomous sampling** – At pre-programmed intervals, the MicroTSG samples and sends the data to the computer. The MicroTSG does not enter quiescent (sleep) state between samples.
- **Serial Line Sync** – A pulse on the serial line causes the MicroTSG to wake up, sample, and enter quiescent state automatically.



Calibration coefficients stored in EEPROM allow the MicroTSG to transmit data in engineering units.

### SENSORS

The MicroTSG retains the temperature and conductivity sensors used in the SBE 21 Thermosalinograph, but has improved acquisition electronics that increase accuracy and resolution, and lower power consumption. The MicroTSG's aged and pressure-protected thermistor has a long history of exceptional accuracy and stability (typical drift is less than 0.002 °C per year). Electrical isolation of the conductivity electronics eliminates any possibility of ground-loop noise.

The MicroTSG's internal-field conductivity cell is unaffected by external fouling, and uses expendable anti-foulant devices.

### OPTIONAL PN90402 - SBE 45 POWER, NAVIGATION, and REMOTE TEMPERATURE INTERFACE BOX

An optional AC- or DC-powered Interface Box:

- Provides isolated DC power and an optically isolated RS-232 data interface.
- Contains a NMEA 0183 port for appending navigation information from a NMEA navigation device to the data stream.
- Contains an RS-232 port for appending the output of an optional remote temperature sensor (SBE 38), allowing for measurement of sea surface temperature with minimal thermal contamination from the ship's hull.
- Outputs the data stream (MicroTSG, NMEA navigation device, and SBE 38 data) to the computer over an RS-232 interface.

### SOFTWARE

The MicroTSG is supplied with a powerful Win 95/98/NT/2000/XP software package, SEASOFT<sup>®</sup>-Win32. SEASOFT's modular programs include:

- SEATERM — terminal program for instrument setup and data display.
- SEASAVE — real-time data acquisition and display
- SBE Data Processing — filtering, aligning, averaging, and plotting of data and derived variables.

# MicroTSG (Thermosalinograph)

**SBE 45**

## SPECIFICATIONS

### Measurement Range

Conductivity: 0-7 S/m (0-70 mS/cm)  
 Temperature \*: -5 to 35 °C

### Initial Accuracy

Conductivity: 0.0003 S/m (0.003 mS/cm)  
 Temperature \*: 0.002 °C  
 Salinity: 0.005 PSU, typical

### Typical Stability (per month)

Conductivity: 0.0003 S/m (0.003 mS/cm)  
 Temperature \*: 0.0002 °C  
 Salinity: 0.003 PSU, typical

### Resolution

Conductivity: 0.00001 S/m (0.0001 mS/cm)  
 Temperature \*: 0.0001 °C  
 Salinity: 0.0002 PSU, typical

### Calibration Range

Conductivity: 0-6 S/m (60 mS/cm); physical calibration 2.6-6 S/m (26-60 mS/cm), plus zero conductivity (air)  
 Temperature \*: +1 to +32 °C

### Time Resolution

1 second

### Clock Stability

13 seconds/month

### Input Power

8-30 VDC

### Acquisition Current

34 mA at 8 VDC; 30 mA at 12-30 VDC

### Quiescent Current

10 microamps

### Acquisition Rate

1 Hz maximum

### Operating Pressure

34.5 decibars (50 psi) maximum

### Flow Rate

10 to 30 ml/sec (0.16 to 0.48 gal/min)

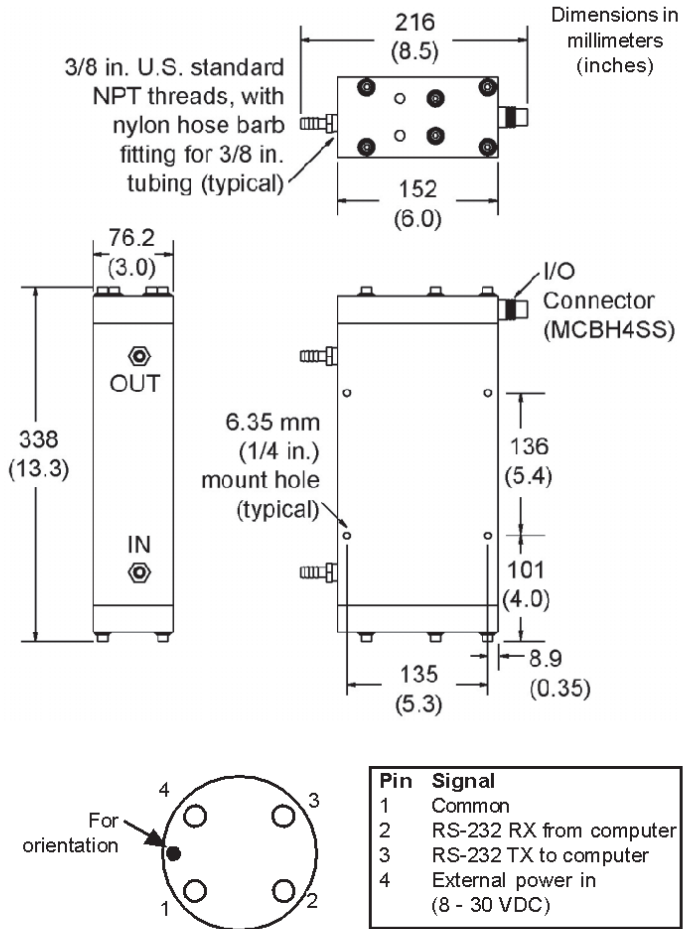
### Materials

PVC housing

### Weight

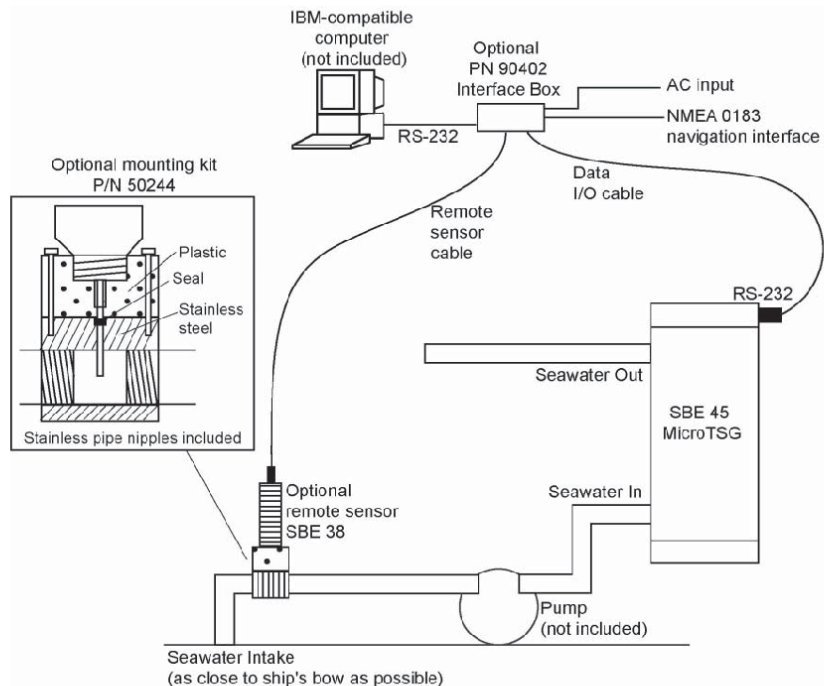
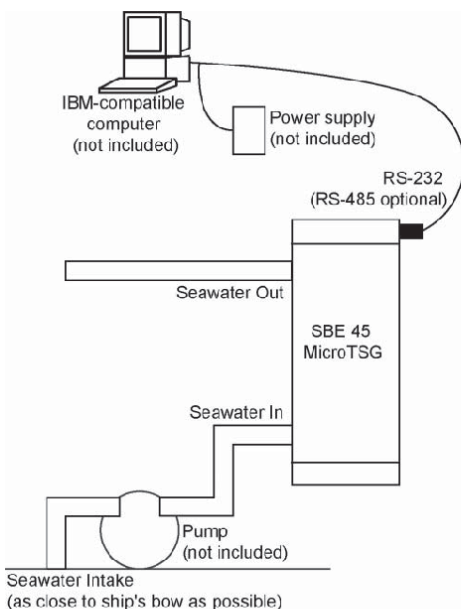
4.6 kg (10.2 lbs)

\* For specifications for optional SBE 38 remote temperature sensor, see SBE 38 datasheet.



## System Schematic: SBE 45 with Optional PN 90402 Interface Box and Remote Temperature Sensor

### System Schematic: SBE 45



03/04



**Sea-Bird Electronics, Inc.**

1808 136th Place NE, Bellevue, Washington 98005 USA

Website: <http://www.seabird.com>

E-mail: [seabird@seabird.com](mailto:seabird@seabird.com)

Telephone: (425) 643-9866

Fax: (425) 643-9954



# SVP 70

A new generation of fixed-mount sound velocity probes



## SVP 70

- Accurate & reliable sound velocity measurement in seawater
- Compact housing in titanium for corrosion immunity and high strength
- Mechanical design for easy cleaning, optimal flow and flexible integration
- Galvanically isolated multiple communication interfaces as standard
- Direct path ultrasonic echosounding with 2MHz transducer element
- Instant electronic temperature and pressure compensation via internal sensors
- Integrated electronics and up to 6000m depth rating



The RESON SVP 70 sound velocity probe is developed for fixed-mount installation on surface ships, outboard rigs, submarines, AUVs, ROVs and other self-propelled platforms. The SVP 70 uses the latest electronic technology combined with an innovative mechanical design to yield a compact, robust, yet very flexible product.

The SVP 70 uses a direct path echosounding technique that instantly compensates for temperature and pressure with internal sensors.

The SVP 70 comes in a water resistant case including brackets for mounting, a 3m accessory cable, bolts, and a user manual with system description. Additional adaptor kits and fairing accessories are available.



# SVP 70

A new generation of fixed-mount sound velocity probes

## PRODUCT SPECIFICATION

### Sound velocity

Range:	1350 -1800m/s
Resolution:	0.01m/s
Accuracy:	(0-50m $\pm$ 0.05m/s
Accuracy:	(6000m) $\pm$ 0.25m/s
Sampling Rate:	20Hz and lower, programmable
Sampling Mode:	On request, continuous

### I/O Interfaces

Connector:	Birns MCBH9MTT* (Titanium)
Output:	(MCBH9M) True RS-232 and True RS-422
Baud Rate:	2400-115200
Galvanic Insulation:	Yes
Output Options:	Direct, filtered, validity
Output Formats:	Universal Programmable ASCII, Valeport, AML, SVP24, NMEA, and others

### Electrical

Supply:	8-55VDC
Current:	150mA @ 12V

### Physical

Diameter:	44mm (maximum)
Length:	165mm (excl. connector)
End-Cap Height:	69mm (maximum)
Connector (MCBH9M):	52.5mm x $\varnothing$ 23mm
Weight:	approximately 1.0kg (excl. cable)

### Environmental

Pressure:	0-630bar
Temperature:	-20 to +55°C

### Sales Package

900-63-0000-00	- SVP 70
904-63-0800-00	- Accessories Kit (5 pcs. DIN912 M6*10, 5 pcs. DIN933 M6*10, 4 x Mounting O-rings, 7.5ml Silicon oil for connectors, Microfibre cloth
7211C03	- 2 x Mounting Brackets with rubber membrane
904-63-0801-00	- Plastic Transport Case
904-63-0802-00	- Operators Manual
904-63-0803-00	- Quick Reference Manual
904-63-0804-00	- Test Cable 1.5m long terminated with RS232 and RS232 D-sub connections
904-63-0808-00	- 25m Wet Cable with connector
906-63-0800-00	- MCA Female locking sleeve

### Optional Cables (All wet cable pigtailed with connectors)

904-63-0805-00	- 1.5m	904-63-0806-00	- 5m	904-63-0807-00	- 10m
904-63-0808-00	- 25m	904-63-0809-00	- 60m		

RESON reserves the right to change specifications without notice. © 2006 RESON A/S  
For Acoustical Measurement Accuracy please refer to [www.reson.com](http://www.reson.com) or contact sales.



**RESON A/S**  
Denmark  
Tel: +45 4738 0022  
E-mail: [reson@reson.com](mailto:reson@reson.com)

**RESON GmbH**  
Germany  
Tel: +49 431 720 7180  
E-mail: [reson@reson-gmbh.de](mailto:reson@reson-gmbh.de)

**RESON Inc.**  
USA  
Tel: +1 805 964-6260  
E-mail: [sales@reson.com](mailto:sales@reson.com)

**RESON B.V.**  
The Netherlands  
Tel: +31 (0) 10 245 1500  
E-mail: [info@reson.nl](mailto:info@reson.nl)

**RESON Offshore Ltd.**  
United Kingdom  
Tel: +44 1224 709 900  
E-mail: [sales@reson.co.uk](mailto:sales@reson.co.uk)

**RESON (Pte.) Ltd.**  
Singapore  
Tel: +65 6725 9851  
E-mail: [sales@reson.com](mailto:sales@reson.com)

[www.reson.com](http://www.reson.com)

# SBE 19plus SEACAT PROFILER

*Conductivity, Temperature, and Pressure Recorder  
with RS-232 Interface*



**Serial Number: 19P36026-4585**

---

Sea-Bird Electronics, Inc.  
1808 136<sup>th</sup> Place NE  
Bellevue, Washington 98005 USA  
Tel: 425/643-9866  
Fax: 425/643-9954

## LIMITED LIABILITY STATEMENT

Extreme care should be exercised when using or servicing this equipment. It should be used or serviced only by personnel with knowledge of and training in the use and maintenance of oceanographic electronic equipment.

SEA-BIRD ELECTRONICS, INC. disclaims all product liability risks arising from the use or servicing of this system. SEA-BIRD ELECTRONICS, INC. has no way of controlling the use of this equipment or of choosing the personnel to operate it, and therefore cannot take steps to comply with laws pertaining to product liability, including laws which impose a duty to warn the user of any dangers involved in operating this equipment. Therefore, acceptance of this system by the customer shall be conclusively deemed to include a covenant by the customer to defend, indemnify, and hold SEA-BIRD ELECTRONICS, INC. harmless from all product liability claims arising from the use of servicing of this system.

## WARNING !!

**Do not submerge this instrument (S/N 19P36026-4585)  
beyond the depth rating of the lowest rated component listed below!**

Main Housing (Titanium)	7000 meters
<b>Pressure Sensor (3500 dBar) Druck</b>	<b>3500 meters</b>
Pump (SBE 5M)	10500 meters

# SYSTEM CONFIGURATION

14 June 2004

Model SBE 19plus	<b>S/N 19P36026-4585</b>
Instrument Type	<b>SBE 19plus SeaCaT Profiler</b>
Firmware Version	<b>1.4D</b>
Communications	<b>9600 baud, 8 data bits, no parity, one stop bit</b>
Memory	<b>8192K</b>
Housing	<b>7000 meter (3AL-4V Titanium)</b>
0 Conductivity Raw Frequency	<b>2630.97 Hz</b>
Pressure Sensor	<b>Strain Gauge: 3500 dBar, S/N 5433</b>
Number of Voltages Sampled:	<b>0</b>
Serial RS-232C Sensor	<b>None</b>
<b>Data Format:</b>	
Count	<b>Temperature</b>
Frequency	<b>Conductivity</b>
Count	<b>Pressure, Strain gauge</b>
Pump (SBE 5M)	<b>050647</b>
Voltage Delay Setting (standard)	<b>(standard) 0 seconds</b>



## IMPORTANT SOFTWARE & HARDWARE CONFIGURATION INFORMATION

Sea-Bird supplies two versions of our software package for communication, real-time data acquisition, and data analysis and display:

- SEASOFT-Win32 - Windows software for PC running Win 95/98/NT/2000/XP
- SEASOFT-DOS - DOS software for IBM-PC/AT/386/486 or compatible computer with a hard drive

Detailed information on the use of the **Windows** software follows:

### SEASOFT-Win32

SEASOFT-Win32 software was supplied on a CD-ROM with your CTD. This software package is designed to run on a PC running Win 95/98/NT/2000/XP. The CD-ROM also contains software manuals that describe the appropriate applications for the various programs, the procedure for installing the software, and instructions on using the programs. There are three primary programs used with the CTD for setup, data collection and retrieval, data display, and data processing:

- SEATERM - terminal program for setup of the CTD and uploading of data from the CTD memory (**Note:** If using the CTD with the 90208 Auto Fire Module or SBE 17*plus* V2 SEARAM, use SeatermAF instead of SEATERM)
- SEASAVE - real-time data acquisition program
- SBE Data Processing - data processing program

Instructions for using the software are found in their Help files.

To communicate with the CTD to set it up or to upload data from the CTD memory to the computer hard drive, **SEATERM** must have information about the CTD hardware configuration (communication parameters, internal firmware, etc.) and about the computer. To communicate with the CTD, double click on Seaterm.exe:

1. In the Configure menu, select the CTD. The Configuration Options dialog box appears.
  - A. On the COM Settings tab, select the firmware version (if applicable), baud rate, data bits, and parity to match the CTD's configuration sheet. If necessary, change the com port to match the computer you are using.
  - B. On the Upload Settings tab, enter upload type (all as a single file, etc.) as desired.  
*For the SBE 17 and 25 only:* enter the serial number for the SBE 3 (temperature) and SBE 4 (conductivity) modular sensors, exactly as they appear in the configuration (.con) file.
  - C. On the Header Information tab, change the settings as desired.
 Click OK when done. SEATERM saves the settings in a SEATERM.ini file.
2. On the Toolbar, click Connect to communicate with the CTD.
3. To set up the CTD prior to deployment:  
On the Toolbar, click Status. SEATERM sends the Status command and displays the response. Verify that the CTD setup matches your desired deployment. If not, send commands to modify the setup.
4. To upload data from the CTD:  
On the Toolbar, click Upload to upload data from the CTD memory to the computer.

Sea-Bird CTDs store and/or transmit data from their primary and auxiliary sensors in the form of binary or hexadecimal number equivalents of the sensors' frequency or voltage outputs. This is referred to as the *raw* data. The calculations required to convert from *raw* data to *engineering* units of the measured parameters (temperature, conductivity, pressure, dissolved oxygen, pH, etc.) are performed using the software, either in real time, or after the data has been stored in a file. SEASAVE creates the file in real time. As noted above, SEATERM uploads the recorded data and creates the file on the computer hard drive.

To successfully store data to a file on the computer and subsequently convert it to engineering units, the software must know the CTD type, CTD configuration, and calibration coefficients for the sensors installed on the CTD. This information is unique to each CTD, and is contained in a *configuration* file. The configuration file, which has a .con extension, was written onto a floppy disk and the CD-ROM shipped with the CTD. The .con file for a given CTD is named with the last four digits of the serial number for that CTD (e.g., 1234.con). The configuration file is created or modified (e.g., changing coefficients after recalibration, or adding another sensor) by using the Configure menu in **SEASAVE** or

**SBE Data Processing.** The configuration file is used by SEASAVE to convert raw data to engineering units when it acquires, stores, and displays real-time data. The configuration file is also used by some modules in SBE Data Processing (Data Conversion and Derive) that convert raw data to engineering units during data processing.

The instrument type and instrument configuration settings of the .con file and the required setup for the SEATERM.ini file for the CTD *as delivered* are documented below. The calibration coefficients for the CTD's sensors are contained in the calibration coefficient section of the CTD manual.

**NOTE:**

SEATERM will not upload data correctly without a properly configured SEATERM.ini file. SEASAVE and SBE Data Processing will not interpret the data correctly without the correct .con file.

**SEASOFT CONFIGURATION:**

The correct instrument type for your instrument is SBE 19plus SEACAT Profiler. The correct settings for the configuration of your instrument as delivered are documented below:

Configuration for the SBE 19 Seacat plus CTD

ASCII file opened: None

Pressure sensor type: Strain Gauge

External voltage channels: 0

Mode: Profile

Sample interval seconds: 10

Scans to average: 1

Surface PAR voltage added

NMEA position data added

Channel	Sensor
1. Count	Temperature
2. Frequency	Conductivity
3. Count	Pressure, Strain Gauge

Buttons: New, Open..., Save, Save As..., Select..., Modify..., Report..., Help..., Exit, Cancel

# SPECIFICATIONS

SBE 19plus Specifications.....	1
SBE 5M Pump.....	3

# SEACAT Profiler

## SBE 19plus



The SBE 19plus is the next generation *Personal CTD*, bringing numerous improvements in accuracy, resolution (in fresh as well as salt water), reliability, and ease-of-use to the wide range of research, monitoring, and engineering applications pioneered by its legendary SEACAT predecessor. The 19plus samples faster (4 Hz vs 2), is more accurate (0.005 vs 0.01 in T, 0.0005 vs 0.001 in C, and 0.1% vs 0.25% — with *seven* times the resolution — in D), and has more memory (8 Mbyte vs 1). There is more power for auxiliary sensors (500 ma vs 50), and they are acquired at higher resolution (14 bit vs 12). Cabling is simpler and more reliable because there are four differential auxiliary inputs on two separate connectors, and a dedicated connector for the pump. All exposed metal parts are titanium, instead of aluminum, for long life and minimum maintenance.

The 19plus can be operated without a computer from even the smallest boat, with data recorded in non-volatile FLASH memory and processed later on your PC. Simultaneous with recording, real-time data can be transmitted over single-core, armored cable directly to your PC's serial port (maximum transmission distance dependent on number of auxiliary sensors, baud rate, and cable properties). The 19plus' faster sampling and pump-controlled TC-ducted flow configuration significantly reduces salinity spiking caused by ship heave, and allows slower descent rates for improved resolution of water column features. Auxiliary sensors for dissolved oxygen, pH, turbidity, fluorescence, PAR, and ORP can be added, and for moored deployments the 19plus can be set to *time-series* mode using software commands. External power and two-way real-time communication over 10,000 meters of cable can be provided with the SBE 36 CTD Deck Unit and Power and Data Interface Module (PDIM).

The 19plus uses the same temperature and conductivity sensors proven in 5000 SEACAT and MicroCAT instruments, and a superior new micro-machined silicon strain gauge pressure sensor developed by Druck, Inc. Improvements in design, materials, and signal acquisition techniques yield a low-cost instrument with superior performance that is also easy to use. Calibration coefficients, obtained in our computer-controlled high-accuracy calibration baths, are stored in EEPROM memory. They permit data output in ASCII engineering units (degrees C, Siemens/m, decibars, Salinity [PSU], sound velocity [m/sec], etc.). The 19plus can be factory-configured to emulate the .hex output format and 2 Hz data rate of old SEACATs for compatibility with existing software or instrument fleets.

Accuracy, convenience, portability, software, and support; compelling reasons why the 19plus is today's best low-cost CTD.

### CONFIGURATION AND OPTIONS

A standard SBE 19plus is supplied with:

- Plastic housing for depths to 600 meters
- Strain-gauge pressure sensor
- 8 Mbyte FLASH RAM memory
- 9 D-size alkaline batteries
- Impulse glass-reinforced epoxy bulkhead connectors: 4-pin I/O, 2-pin pump, and two 6-pin (two differential auxiliary A/D inputs each)
- SBE 5M miniature pump and T-C Duct

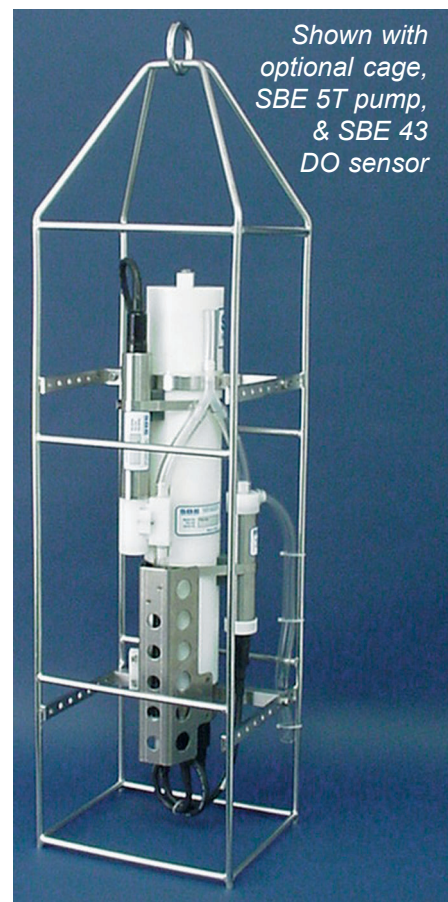
Options include:

- Titanium housing for depths to 7000 meters
- Sensors for oxygen, pH, fluorescence, light (PAR), light transmission, and turbidity
- SBE 5T pump in place of SBE 5M for use with dissolved oxygen and/or other pumped sensors
- Stainless steel cage
- MCBH *Micro* connectors
- Ni-Cad batteries and charger

### SOFTWARE

SEASOFT®-Win32, our complete Windows 95/98/NT/2000/XP software package, is included at no extra charge. Its modular programs include:

- SEATERM® — communication and data retrieval
- SEASAVE® — real-time data acquisition and display
- SBE Data Processing® — filtering, aligning, averaging, and plotting of CTD and auxiliary sensor data and derived variables



*Shown with  
optional cage,  
SBE 5T pump,  
& SBE 43  
DO sensor*



**Sea-Bird Electronics, Inc.**

1808 136th Place NE, Bellevue, Washington 98005 USA

Website: <http://www.seabird.com>

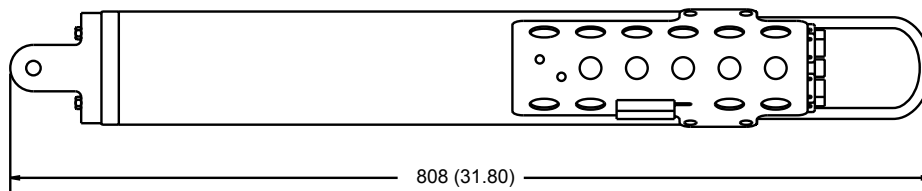
Email: [seabird@seabird.com](mailto:seabird@seabird.com)

Telephone: (425) 643-9866

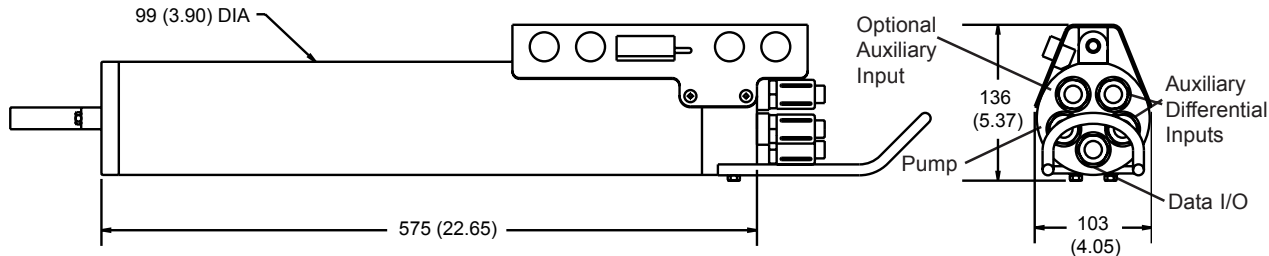
Fax: (425) 643-9954

# SEACAT Profiler

# SBE 19plus

Dimensions  
in millimeters  
(inches)



## SPECIFICATIONS

### Measurement Range

Temperature	-5 to +35 °C
Conductivity	0 to 9 S/m
Pressure	0 to 20 / 100 / 350 / 1000 / 2000 / 3500 / 7000 meters

### Initial Accuracy

Temperature	0.005 °C
Conductivity	0.0005 S/m
Pressure	0.1% of full scale range

### Typical Stability (per month)

Temperature	0.0002 °C
Conductivity	0.0003 S/m
Pressure	0.004% of full scale range

### Resolution

Temperature	0.0001 °C
Conductivity	0.00005 S/m (most oceanic waters; resolves 0.4 ppm in salinity)
	0.00007 S/m (high salinity waters; resolves 0.4 ppm in salinity)
	0.00001 S/m (fresh waters; resolves 0.1 ppm in salinity)
Pressure	0.002% of full scale range

**Memory** 8 Mbyte non-volatile FLASH memory

Data Storage	Recorded Parameter	Bytes/Sample
	T + C	6
	pressure	5
	each external voltage	2

**Real-Time Clock** 32,768 Hz TCXO accurate to ±1 minute/year

**Internal Batteries** 9 alkaline D-cells provide 60 hours continuous CTD operation; optional 9-cell rechargeable nickel-cadmium battery pack provides approximately 24 hours operation per charge

**External Power Supply** 9 - 28 VDC

### Power Requirements

Sampling	65 mA
SBE 5M pump	95 mA
Quiescent	30 µA

### Auxiliary Voltage Sensors

Auxiliary power out	up to 500 mA at 10.5 - 11 VDC
A/D resolution	14 bits
Input range	0 - 5 VDC

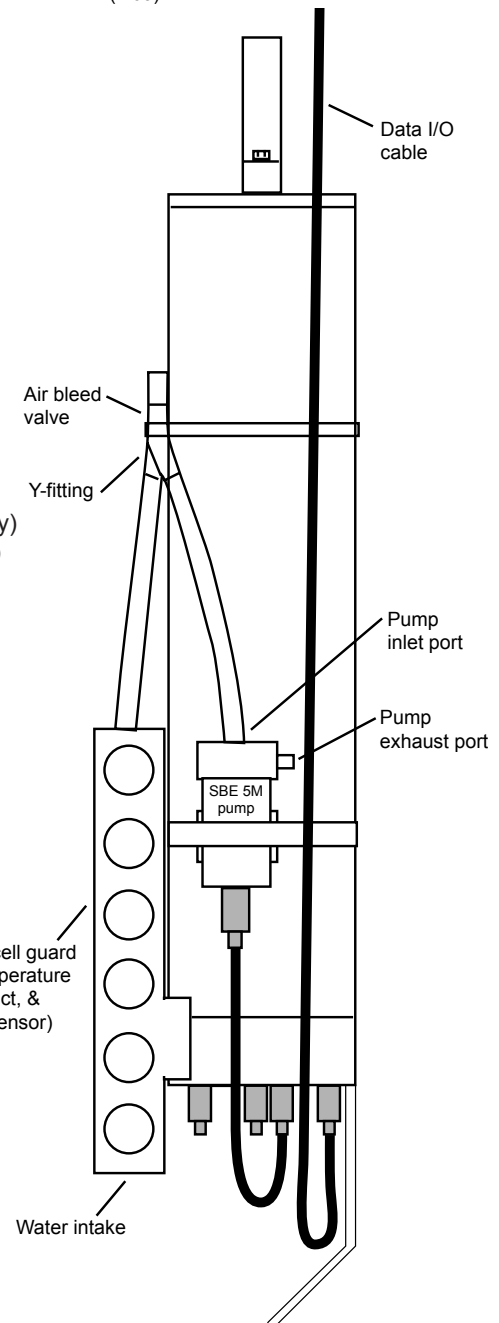
### Housing Materials — Depth Rating — Weight

Acetal Copolymer Plastic housing — 600 meter (1950 feet) — 7.3 kg (16 lbs)  
3AL-2.5V Titanium housing — 7000 meter (22,900 feet) — 13.7 kg (30 lbs)



**Sea-Bird Electronics, Inc.**

1808 136th Place NE, Bellevue, Washington 98005 USA  
Website: <http://www.seabird.com>



Email: [seabird@seabird.com](mailto:seabird@seabird.com)  
Telephone: (425) 643-9866  
Fax: (425) 643-9954

# Mini Submersible Pump

## SBE 5M



The SBE 5M pump module consists of a centrifugal pump head and a long-life, DC ball bearing motor contained in a compact, titanium, pressure housing usable to 10,500 meters deep. The pump impeller and electric drive motor are coupled magnetically through the housing, providing high reliability by eliminating moving seals. Motor speed and pumping rate remain constant over the entire input voltage range. The motor drive electronics is intrinsically protected against accidental reversed polarity.

### APPLICATIONS

The SBE 5M is standard on the SBE 19 and 19*plus* SEACAT Profiler CTD. It is optional on the SBE 16, 16*plus*, and 16*plus*-IM SEACAT C-T Recorder. The pump flushes water through the conductivity cell at a constant rate, independent of the CTD's motion, improving dynamic performance. For applications requiring pumping through additional sensors (for example, a dissolved oxygen sensor), use the SBE 5T pump instead.

Specify:

- Option 5M-1 for profiling (continuous duty) applications such as the SBE 19*plus*.
- Option 5M-2 for moored (pulsed duty) applications such as the SBE 16*plus* or 16*plus*-IM.

Contact Sea-Bird for use in other applications.

### SPECIFICATIONS

#### Option 5M-1 (continuous duty):

**Input voltage range 9 - 18 VDC**

Flow Rate 25 ml/s                      supply current 95 ma

Note: Supply current is independent of operating voltage.

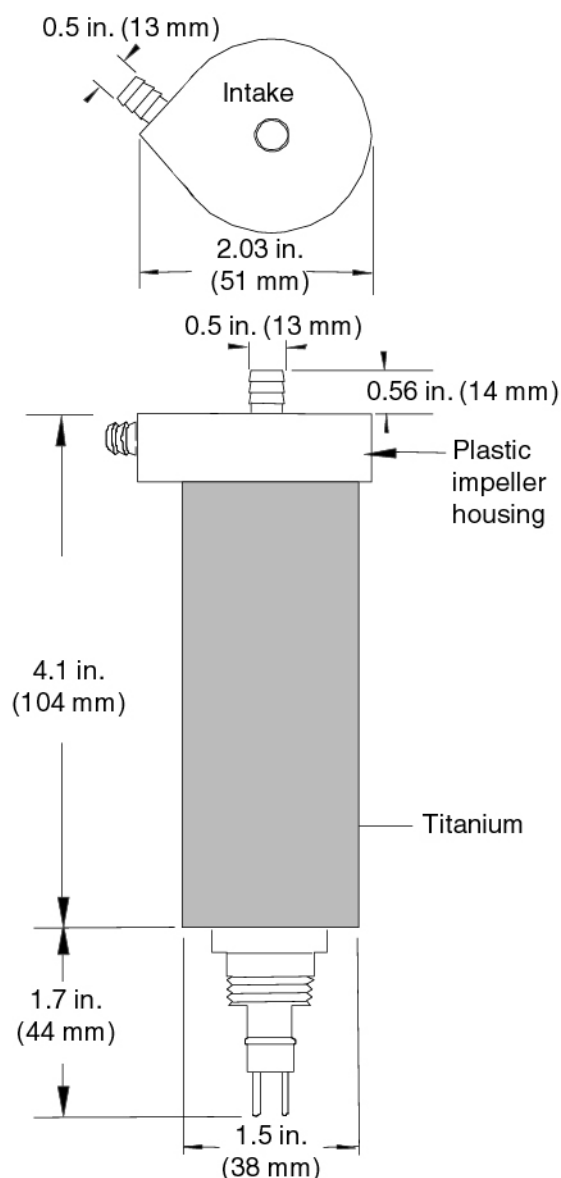
#### Option 5M-2 (pulsed duty):

**Input voltage range 6 - 18 VDC**

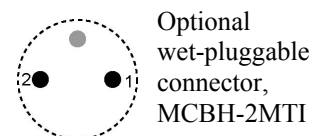
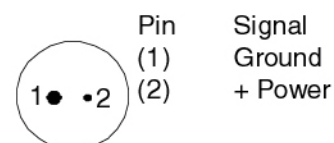
Pulse Duration	Flow Volume	Electrical Charge
0.5 seconds	15 ml	0.148 amp-seconds
1.0 seconds	21 ml	0.283 amp-seconds
1.5 seconds	31 ml	0.418 amp-seconds
2.0 seconds	40 ml	0.553 amp-seconds

#### Weight

In Air:                      0.42 kg (0.91 lbs)  
In Water:                    0.28 kg (0.60 lbs)



XSG-2BCL-HP-SS



06/03



Sea-Bird Electronics, Inc.

1808 136th Place NE, Bellevue, Washington 98005 USA

Website: <http://www.seabird.com>

FAX: (425) 643-9954

Tel: (425) 643-9866

Email: [seabird@seabird.com](mailto:seabird@seabird.com)

## SBE 5M MINI SUBMERSIBLE PUMP CONFIGURATION SHEET

Serial Number: 0647  
 Job Number: 36026  
 Customer: NOAA/PMC  
 Delivery Date: 6/14/2004

Single Connector Housing with Titanium screws

Pressure Case: 10,500 meters (titanium)

Maxon Motor Type:

P/N 90337, Motor PN 20130 (Low power 6 VDC, 2000 RPM MAX)

P/N 90335, Motor PN 20130 (Low power 9 VDC, 2000 RPM MAX)

Vin 15V voltage across C2: **8.015** VDC Current **7.73** mA

Vin 9V voltage across C2: **8.014** VDC Current **7.4** mA

Vin 6V voltage across C2: **5.888** VDC Current **7.61** mA

Pump submerged test, no load, Vin 12VDC Average current draw in water: **121** mA

# SBE 19plus SEACAT PROFILER

*Conductivity, Temperature, and Pressure Recorder  
with RS-232 Interface*



**Serial Number: 19P36026-4616**

---

Sea-Bird Electronics, Inc.  
1808 136<sup>th</sup> Place NE  
Bellevue, Washington 98005 USA  
Tel: 425/643-9866  
Fax: 425/643-9954



## **WARNING !!**

**Do not submerge this instrument (S/N 19P36026-4616)  
beyond the depth rating of the lowest rated component listed below!**

<b>Main Housing (Plastic)</b>	<b>600 meters</b>
Pressure Sensor (1000 dBar) Druck	1000 meters
Pump (SBE 5M)	10500 meters

# SYSTEM CONFIGURATION

14 June 2004

Model SBE 19plus	<b>S/N 19P36026-4616</b>
Instrument Type	<b>SBE 19plus SeaCaT Profiler</b>
Firmware Version	<b>1.4D</b>
Communications	<b>9600 baud, 8 data bits, no parity, one stop bit</b>
Memory	<b>8192K</b>
Housing	<b>600 meter (Celcon plastic)</b>
0 Conductivity Raw Frequency	<b>2686.52 Hz</b>
Pressure Sensor	<b>Strain Gauge: 1000 dBar, S/N 5512</b>
Number of Voltages Sampled:	<b>0</b>
Serial RS-232C Sensor	<b>None</b>
<b>Data Format:</b>	
Count	<b>Temperature</b>
Frequency	<b>Conductivity</b>
Count	<b>Pressure, Strain gauge</b>
Pump (SBE 5M)	<b>050651</b>
Voltage Delay Setting (standard)	<b>(standard) 0 seconds</b>

## IMPORTANT SOFTWARE & HARDWARE CONFIGURATION INFORMATION

Sea-Bird supplies two versions of our software package for communication, real-time data acquisition, and data analysis and display:

- SEASOFT-Win32 - Windows software for PC running Win 95/98/NT/2000/XP
- SEASOFT-DOS - DOS software for IBM-PC/AT/386/486 or compatible computer with a hard drive

Detailed information on the use of the **Windows** software follows:

### SEASOFT-Win32

SEASOFT-Win32 software was supplied on a CD-ROM with your CTD. This software package is designed to run on a PC running Win 95/98/NT/2000/XP. The CD-ROM also contains software manuals that describe the appropriate applications for the various programs, the procedure for installing the software, and instructions on using the programs. There are three primary programs used with the CTD for setup, data collection and retrieval, data display, and data processing:

- SEATERM - terminal program for setup of the CTD and uploading of data from the CTD memory (**Note:** If using the CTD with the 90208 Auto Fire Module or SBE 17*plus* V2 SEARAM, use SeatermAF instead of SEATERM)
- SEASAVE - real-time data acquisition program
- SBE Data Processing - data processing program

Instructions for using the software are found in their Help files.

To communicate with the CTD to set it up or to upload data from the CTD memory to the computer hard drive, **SEATERM** must have information about the CTD hardware configuration (communication parameters, internal firmware, etc.) and about the computer. To communicate with the CTD, double click on Seaterm.exe:

1. In the Configure menu, select the CTD. The Configuration Options dialog box appears.
  - A. On the COM Settings tab, select the firmware version (if applicable), baud rate, data bits, and parity to match the CTD's configuration sheet. If necessary, change the com port to match the computer you are using.
  - B. On the Upload Settings tab, enter upload type (all as a single file, etc.) as desired.  
*For the SBE 17 and 25 only:* enter the serial number for the SBE 3 (temperature) and SBE 4 (conductivity) modular sensors, exactly as they appear in the configuration (.con) file.
  - C. On the Header Information tab, change the settings as desired.

Click OK when done. SEATERM saves the settings in a SEATERM.ini file.
2. On the Toolbar, click Connect to communicate with the CTD.
3. To set up the CTD prior to deployment:  
On the Toolbar, click Status. SEATERM sends the Status command and displays the response. Verify that the CTD setup matches your desired deployment. If not, send commands to modify the setup.
4. To upload data from the CTD:  
On the Toolbar, click Upload to upload data from the CTD memory to the computer.

Sea-Bird CTDs store and/or transmit data from their primary and auxiliary sensors in the form of binary or hexadecimal number equivalents of the sensors' frequency or voltage outputs. This is referred to as the *raw* data. The calculations required to convert from *raw* data to *engineering* units of the measured parameters (temperature, conductivity, pressure, dissolved oxygen, pH, etc.) are performed using the software, either in real time, or after the data has been stored in a file. SEASAVE creates the file in real time. As noted above, SEATERM uploads the recorded data and creates the file on the computer hard drive.

To successfully store data to a file on the computer and subsequently convert it to engineering units, the software must know the CTD type, CTD configuration, and calibration coefficients for the sensors installed on the CTD. This information is unique to each CTD, and is contained in a *configuration* file. The configuration file, which has a .con extension, was written onto a floppy disk and the CD-ROM shipped with the CTD. The .con file for a given CTD is named with the last four digits of the serial number for that CTD (e.g., 1234.con). The configuration file is created or modified (e.g., changing coefficients after recalibration, or adding another sensor) by using the Configure menu in **SEASAVE** or

**SBE Data Processing.** The configuration file is used by SEASAVE to convert raw data to engineering units when it acquires, stores, and displays real-time data. The configuration file is also used by some modules in SBE Data Processing (Data Conversion and Derive) that convert raw data to engineering units during data processing.

The instrument type and instrument configuration settings of the .con file and the required setup for the SEATERM.ini file for the CTD *as delivered* are documented below. The calibration coefficients for the CTD's sensors are contained in the calibration coefficient section of the CTD manual.

**NOTE:**

SEATERM will not upload data correctly without a properly configured SEATERM.ini file. SEASAVE and SBE Data Processing will not interpret the data correctly without the correct .con file.

**SEASOFT CONFIGURATION:**

The correct instrument type for your instrument is SBE 19plus SEACAT Profiler. The correct settings for the configuration of your instrument as delivered are documented below:

Configuration for the SBE 19 Seacat plus CTD

ASCII file opened: None

Pressure sensor type: Strain Gauge

External voltage channels: 0

Mode: Profile

Sample interval seconds: 10

Scans to average: 1

Surface PAR voltage added

NMEA position data added

Channel	Sensor
1. Count	Temperature
2. Frequency	Conductivity
3. Count	Pressure, Strain Gauge

Buttons: New, Open..., Save, Save As..., Select..., Modify..., Report..., Help..., Exit, Cancel

# SPECIFICATIONS

SBE 19plus Specifications.....	1
SBE 5M Pump.....	3

# SEACAT Profiler

## SBE 19plus



The SBE 19plus is the next generation *Personal CTD*, bringing numerous improvements in accuracy, resolution (in fresh as well as salt water), reliability, and ease-of-use to the wide range of research, monitoring, and engineering applications pioneered by its legendary SEACAT predecessor. The 19plus samples faster (4 Hz vs 2), is more accurate (0.005 vs 0.01 in T, 0.0005 vs 0.001 in C, and 0.1% vs 0.25% — with *seven* times the resolution — in D), and has more memory (8 Mbyte vs 1). There is more power for auxiliary sensors (500 ma vs 50), and they are acquired at higher resolution (14 bit vs 12). Cabling is simpler and more reliable because there are four differential auxiliary inputs on two separate connectors, and a dedicated connector for the pump. All exposed metal parts are titanium, instead of aluminum, for long life and minimum maintenance.

The 19plus can be operated without a computer from even the smallest boat, with data recorded in non-volatile FLASH memory and processed later on your PC. Simultaneous with recording, real-time data can be transmitted over single-core, armored cable directly to your PC's serial port (maximum transmission distance dependent on number of auxiliary sensors, baud rate, and cable properties). The 19plus' faster sampling and pump-controlled TC-ducted flow configuration significantly reduces salinity spiking caused by ship heave, and allows slower descent rates for improved resolution of water column features. Auxiliary sensors for dissolved oxygen, pH, turbidity, fluorescence, PAR, and ORP can be added, and for moored deployments the 19plus can be set to *time-series* mode using software commands. External power and two-way real-time communication over 10,000 meters of cable can be provided with the SBE 36 CTD Deck Unit and Power and Data Interface Module (PDIM).

The 19plus uses the same temperature and conductivity sensors proven in 5000 SEACAT and MicroCAT instruments, and a superior new micro-machined silicon strain gauge pressure sensor developed by Druck, Inc. Improvements in design, materials, and signal acquisition techniques yield a low-cost instrument with superior performance that is also easy to use. Calibration coefficients, obtained in our computer-controlled high-accuracy calibration baths, are stored in EEPROM memory. They permit data output in ASCII engineering units (degrees C, Siemens/m, decibars, Salinity [PSU], sound velocity [m/sec], etc.). The 19plus can be factory-configured to emulate the .hex output format and 2 Hz data rate of old SEACATs for compatibility with existing software or instrument fleets.

Accuracy, convenience, portability, software, and support; compelling reasons why the 19plus is today's best low-cost CTD.

### CONFIGURATION AND OPTIONS

A standard SBE 19plus is supplied with:

- Plastic housing for depths to 600 meters
- Strain-gauge pressure sensor
- 8 Mbyte FLASH RAM memory
- 9 D-size alkaline batteries
- Impulse glass-reinforced epoxy bulkhead connectors: 4-pin I/O, 2-pin pump, and two 6-pin (two differential auxiliary A/D inputs each)
- SBE 5M miniature pump and T-C Duct

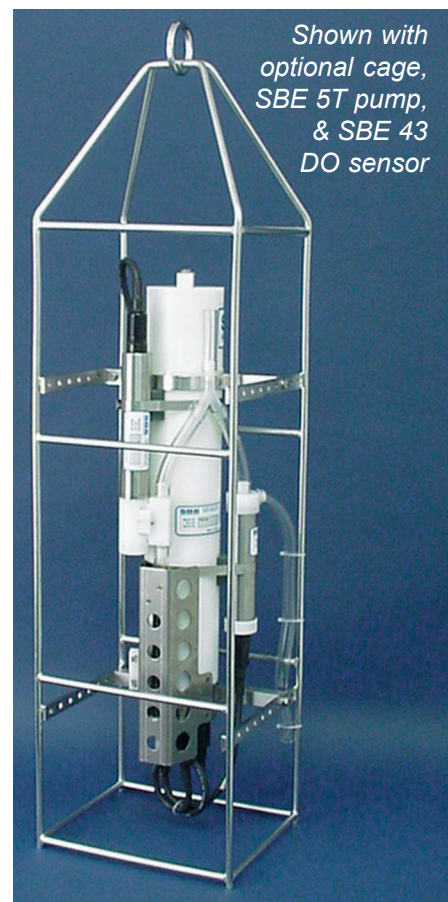
Options include:

- Titanium housing for depths to 7000 meters
- Sensors for oxygen, pH, fluorescence, light (PAR), light transmission, and turbidity
- SBE 5T pump in place of SBE 5M for use with dissolved oxygen and/or other pumped sensors
- Stainless steel cage
- MCBH *Micro* connectors
- Ni-Cad batteries and charger

### SOFTWARE

SEASOFT®-Win32, our complete Windows 95/98/NT/2000/XP software package, is included at no extra charge. Its modular programs include:

- SEATERM® — communication and data retrieval
- SEASAVE® — real-time data acquisition and display
- SBE Data Processing® — filtering, aligning, averaging, and plotting of CTD and auxiliary sensor data and derived variables



Shown with  
optional cage,  
SBE 5T pump,  
& SBE 43  
DO sensor



**Sea-Bird Electronics, Inc.**

1808 136th Place NE, Bellevue, Washington 98005 USA

Website: <http://www.seabird.com>

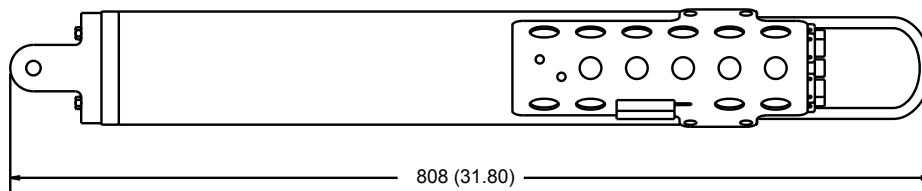
Email: [seabird@seabird.com](mailto:seabird@seabird.com)

Telephone: (425) 643-9866

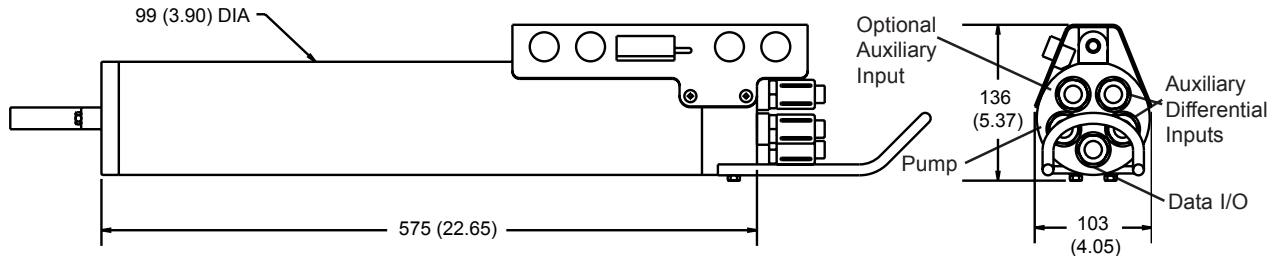
Fax: (425) 643-9954

# SEACAT Profiler

# SBE 19plus

Dimensions  
in millimeters  
(inches)



## SPECIFICATIONS

### Measurement Range

Temperature	-5 to +35 °C
Conductivity	0 to 9 S/m
Pressure	0 to 20 / 100 / 350 / 1000 / 2000 / 3500 / 7000 meters

### Initial Accuracy

Temperature	0.005 °C
Conductivity	0.0005 S/m
Pressure	0.1% of full scale range

### Typical Stability (per month)

Temperature	0.0002 °C
Conductivity	0.0003 S/m
Pressure	0.004% of full scale range

### Resolution

Temperature	0.0001 °C
Conductivity	0.00005 S/m (most oceanic waters; resolves 0.4 ppm in salinity)
	0.00007 S/m (high salinity waters; resolves 0.4 ppm in salinity)
	0.00001 S/m (fresh waters; resolves 0.1 ppm in salinity)
Pressure	0.002% of full scale range

### Memory

8 Mbyte non-volatile FLASH memory

### Data Storage

Recorded Parameter	Bytes/Sample
T + C	6
pressure	5
each external voltage	2

### Real-Time Clock

32,768 Hz TCXO accurate to ±1 minute/year

### Internal Batteries

9 alkaline D-cells provide 60 hours continuous CTD operation; optional 9-cell rechargeable nickel-cadmium battery pack provides approximately 24 hours operation per charge

### External Power Supply

9 - 28 VDC

### Power Requirements

Sampling	65 mA
SBE 5M pump	95 mA
Quiescent	30 µA

### Auxiliary Voltage Sensors

Auxiliary power out	up to 500 mA at 10.5 - 11 VDC
A/D resolution	14 bits
Input range	0 - 5 VDC

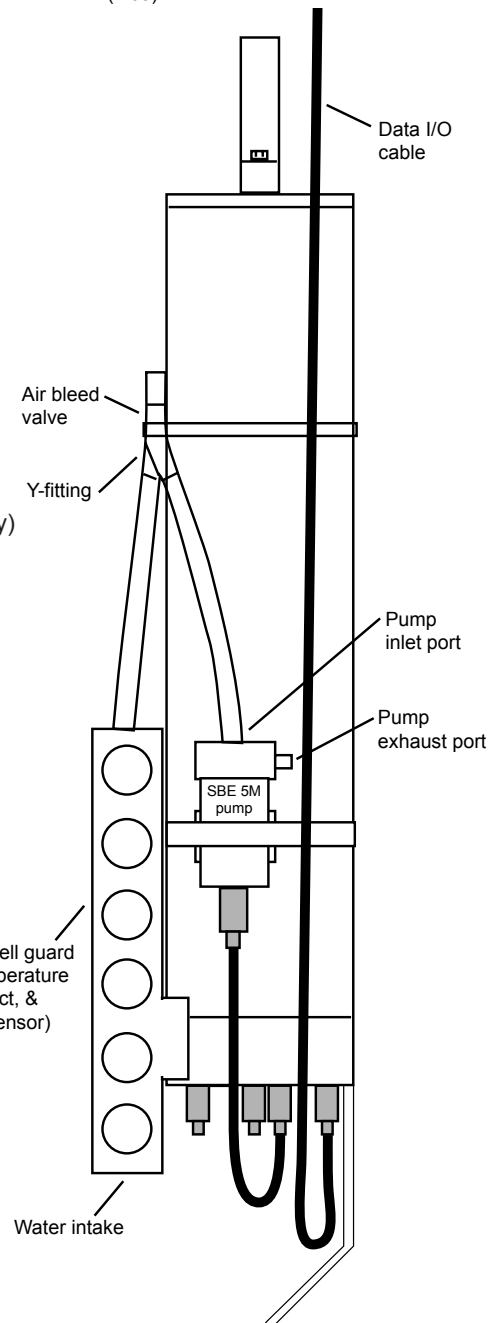
### Housing Materials — Depth Rating — Weight

Acetal Copolymer Plastic housing — 600 meter (1950 feet) — 7.3 kg (16 lbs)  
3AL-2.5V Titanium housing — 7000 meter (22,900 feet) — 13.7 kg (30 lbs)



**Sea-Bird Electronics, Inc.**

1808 136th Place NE, Bellevue, Washington 98005 USA  
Website: <http://www.seabird.com>



Email: [seabird@seabird.com](mailto:seabird@seabird.com)  
Telephone: (425) 643-9866  
Fax: (425) 643-9954

# Mini Submersible Pump

## SBE 5M



The SBE 5M pump module consists of a centrifugal pump head and a long-life, DC ball bearing motor contained in a compact, titanium, pressure housing usable to 10,500 meters deep. The pump impeller and electric drive motor are coupled magnetically through the housing, providing high reliability by eliminating moving seals. Motor speed and pumping rate remain constant over the entire input voltage range. The motor drive electronics is intrinsically protected against accidental reversed polarity.

### APPLICATIONS

The SBE 5M is standard on the SBE 19 and 19*plus* SEACAT Profiler CTD. It is optional on the SBE 16, 16*plus*, and 16*plus*-IM SEACAT C-T Recorder. The pump flushes water through the conductivity cell at a constant rate, independent of the CTD's motion, improving dynamic performance. For applications requiring pumping through additional sensors (for example, a dissolved oxygen sensor), use the SBE 5T pump instead.

Specify:

- Option 5M-1 for profiling (continuous duty) applications such as the SBE 19*plus*.
- Option 5M-2 for moored (pulsed duty) applications such as the SBE 16*plus* or 16*plus*-IM.

Contact Sea-Bird for use in other applications.

### SPECIFICATIONS

#### Option 5M-1 (continuous duty):

**Input voltage range 9 - 18 VDC**

Flow Rate 25 ml/s                      supply current 95 ma

Note: Supply current is independent of operating voltage.

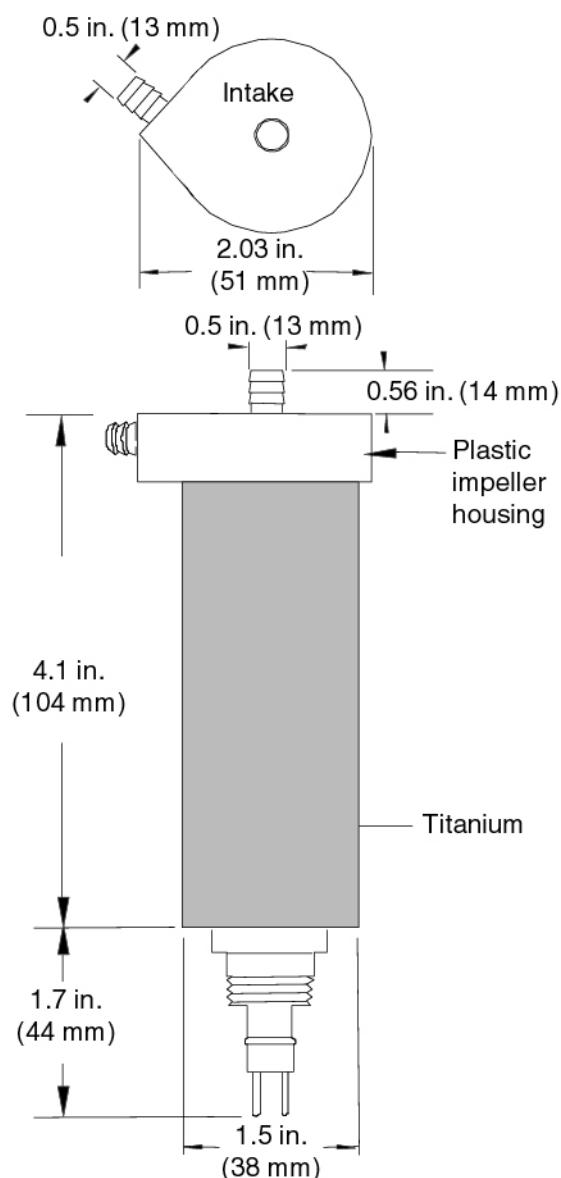
#### Option 5M-2 (pulsed duty):

**Input voltage range 6 - 18 VDC**

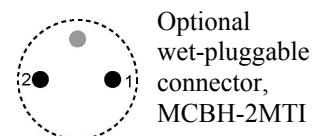
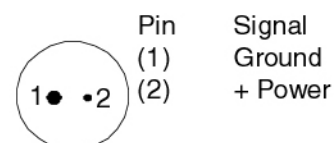
Pulse Duration	Flow Volume	Electrical Charge
0.5 seconds	15 ml	0.148 amp-seconds
1.0 seconds	21 ml	0.283 amp-seconds
1.5 seconds	31 ml	0.418 amp-seconds
2.0 seconds	40 ml	0.553 amp-seconds

#### Weight

In Air:                      0.42 kg (0.91 lbs)  
In Water:                    0.28 kg (0.60 lbs)



XSG-2BCL-HP-SS



06/03





Sea-Bird Electronics, Inc.

1808 136th Place NE, Bellevue, Washington 98005 USA

Website: <http://www.seabird.com>

FAX: (425) 643-9954

Tel: (425) 643-9866

Email: [seabird@seabird.com](mailto:seabird@seabird.com)

## SBE 5M MINI SUBMERSIBLE PUMP CONFIGURATION SHEET

Serial Number: 0651

Job Number: 36026

Customer: NOAA/PMC

Delivery Date: 6/14/2004

Single Connector Housing with Titanium screws

Pressure Case: 10,500 meters (titanium)

Maxon Motor Type:

P/N 90337, Motor PN 20130 (Low power 6 VDC, 2000 RPM MAX)

P/N 90335, Motor PN 20130 (Low power 9 VDC, 2000 RPM MAX)

Vin 15V voltage across C2: **7.929** VDC Current **9.29** mA

Vin 9V voltage across C2: **7.928** VDC Current **8.8** mA

Vin 6V voltage across C2: **5.885** VDC Current **7.99** mA

Pump submerged test, no load, Vin 12VDC Average current draw in water: **120** mA

# SBE 19plus SEACAT PROFILER

*Conductivity, Temperature, and Pressure Recorder  
with RS-232 Interface*



**Serial Number: 19P36026-4617**

---

Sea-Bird Electronics, Inc.  
1808 136<sup>th</sup> Place NE  
Bellevue, Washington 98005 USA  
Tel: 425/643-9866  
Fax: 425/643-9954

## LIMITED LIABILITY STATEMENT

Extreme care should be exercised when using or servicing this equipment. It should be used or serviced only by personnel with knowledge of and training in the use and maintenance of oceanographic electronic equipment.

SEA-BIRD ELECTRONICS, INC. disclaims all product liability risks arising from the use or servicing of this system. SEA-BIRD ELECTRONICS, INC. has no way of controlling the use of this equipment or of choosing the personnel to operate it, and therefore cannot take steps to comply with laws pertaining to product liability, including laws which impose a duty to warn the user of any dangers involved in operating this equipment. Therefore, acceptance of this system by the customer shall be conclusively deemed to include a covenant by the customer to defend, indemnify, and hold SEA-BIRD ELECTRONICS, INC. harmless from all product liability claims arising from the use of servicing of this system.

# WARNING !!

**Do not submerge this instrument (S/N 19P36026-4617) beyond the depth rating of the lowest rated component listed below!**

<b>Main Housing (Plastic)</b>	<b>600 meters</b>
Pressure Sensor (1000 dBar) Druck	1000 meters
Pump (SBE 5M)	10500 meters

# SYSTEM CONFIGURATION

14 June 2004

Model SBE 19plus	<b>S/N 19P36026-4617</b>
Instrument Type	<b>SBE 19plus SeaCaT Profiler</b>
Firmware Version	<b>1.4D</b>
Communications	<b>9600 baud, 8 data bits, no parity, one stop bit</b>
Memory	<b>8192K</b>
Housing	<b>600 meter (Celcon plastic)</b>
0 Conductivity Raw Frequency	<b>2801.47 Hz</b>
Pressure Sensor	<b>Strain Gauge: 1000 dBar, S/N 5513</b>
Number of Voltages Sampled:	<b>0</b>
Serial RS-232C Sensor	<b>None</b>
<b>Data Format:</b>	
Count	<b>Temperature</b>
Frequency	<b>Conductivity</b>
Count	<b>Pressure, Strain gauge</b>
Pump (SBE 5M)	<b>050649</b>
Voltage Delay Setting (standard)	<b>(standard) 0 seconds</b>

## IMPORTANT SOFTWARE & HARDWARE CONFIGURATION INFORMATION

Sea-Bird supplies two versions of our software package for communication, real-time data acquisition, and data analysis and display:

- SEASOFT-Win32 - Windows software for PC running Win 95/98/NT/2000/XP
- SEASOFT-DOS - DOS software for IBM-PC/AT/386/486 or compatible computer with a hard drive

Detailed information on the use of the **Windows** software follows:

### SEASOFT-Win32

SEASOFT-Win32 software was supplied on a CD-ROM with your CTD. This software package is designed to run on a PC running Win 95/98/NT/2000/XP. The CD-ROM also contains software manuals that describe the appropriate applications for the various programs, the procedure for installing the software, and instructions on using the programs. There are three primary programs used with the CTD for setup, data collection and retrieval, data display, and data processing:

- SEATERM - terminal program for setup of the CTD and uploading of data from the CTD memory (**Note:** If using the CTD with the 90208 Auto Fire Module or SBE 17*plus* V2 SEARAM, use SeatermAF instead of SEATERM)
- SEASAVE - real-time data acquisition program
- SBE Data Processing - data processing program

Instructions for using the software are found in their Help files.

To communicate with the CTD to set it up or to upload data from the CTD memory to the computer hard drive, **SEATERM** must have information about the CTD hardware configuration (communication parameters, internal firmware, etc.) and about the computer. To communicate with the CTD, double click on Seaterm.exe:

1. In the Configure menu, select the CTD. The Configuration Options dialog box appears.
  - A. On the COM Settings tab, select the firmware version (if applicable), baud rate, data bits, and parity to match the CTD's configuration sheet. If necessary, change the com port to match the computer you are using.
  - B. On the Upload Settings tab, enter upload type (all as a single file, etc.) as desired.  
*For the SBE 17 and 25 only:* enter the serial number for the SBE 3 (temperature) and SBE 4 (conductivity) modular sensors, exactly as they appear in the configuration (.con) file.
  - C. On the Header Information tab, change the settings as desired.

Click OK when done. SEATERM saves the settings in a SEATERM.ini file.
2. On the Toolbar, click Connect to communicate with the CTD.
3. To set up the CTD prior to deployment:  
On the Toolbar, click Status. SEATERM sends the Status command and displays the response. Verify that the CTD setup matches your desired deployment. If not, send commands to modify the setup.
4. To upload data from the CTD:  
On the Toolbar, click Upload to upload data from the CTD memory to the computer.

Sea-Bird CTDs store and/or transmit data from their primary and auxiliary sensors in the form of binary or hexadecimal number equivalents of the sensors' frequency or voltage outputs. This is referred to as the *raw* data. The calculations required to convert from *raw* data to *engineering* units of the measured parameters (temperature, conductivity, pressure, dissolved oxygen, pH, etc.) are performed using the software, either in real time, or after the data has been stored in a file. SEASAVE creates the file in real time. As noted above, SEATERM uploads the recorded data and creates the file on the computer hard drive.

To successfully store data to a file on the computer and subsequently convert it to engineering units, the software must know the CTD type, CTD configuration, and calibration coefficients for the sensors installed on the CTD. This information is unique to each CTD, and is contained in a *configuration* file. The configuration file, which has a .con extension, was written onto a floppy disk and the CD-ROM shipped with the CTD. The .con file for a given CTD is named with the last four digits of the serial number for that CTD (e.g., 1234.con). The configuration file is created or modified (e.g., changing coefficients after recalibration, or adding another sensor) by using the Configure menu in **SEASAVE** or

**SBE Data Processing.** The configuration file is used by SEASAVE to convert raw data to engineering units when it acquires, stores, and displays real-time data. The configuration file is also used by some modules in SBE Data Processing (Data Conversion and Derive) that convert raw data to engineering units during data processing.

The instrument type and instrument configuration settings of the .con file and the required setup for the SEATERM.ini file for the CTD *as delivered* are documented below. The calibration coefficients for the CTD's sensors are contained in the calibration coefficient section of the CTD manual.

**NOTE:**

SEATERM will not upload data correctly without a properly configured SEATERM.ini file. SEASAVE and SBE Data Processing will not interpret the data correctly without the correct .con file.

**SEASOFT CONFIGURATION:**

The correct instrument type for your instrument is SBE 19plus SEACAT Profiler. The correct settings for the configuration of your instrument as delivered are documented below:

Configuration for the SBE 19 Seacat plus CTD

ASCII file opened: None

Pressure sensor type: Strain Gauge

External voltage channels: 0

Mode: Profile

Sample interval seconds: 10

Scans to average: 1

Surface PAR voltage added

NMEA position data added

Channel	Sensor
1. Count	Temperature
2. Frequency	Conductivity
3. Count	Pressure, Strain Gauge

Buttons: New, Open..., Save, Save As..., Select..., Modify..., Report..., Help..., Exit, Cancel

# SPECIFICATIONS

SBE 19plus Specifications.....	1
SBE 5M Pump.....	3



# SEACAT Profiler

## SBE 19plus



The SBE 19plus is the next generation *Personal CTD*, bringing numerous improvements in accuracy, resolution (in fresh as well as salt water), reliability, and ease-of-use to the wide range of research, monitoring, and engineering applications pioneered by its legendary SEACAT predecessor. The 19plus samples faster (4 Hz vs 2), is more accurate (0.005 vs 0.01 in T, 0.0005 vs 0.001 in C, and 0.1% vs 0.25% — with *seven* times the resolution — in D), and has more memory (8 Mbyte vs 1). There is more power for auxiliary sensors (500 ma vs 50), and they are acquired at higher resolution (14 bit vs 12). Cabling is simpler and more reliable because there are four differential auxiliary inputs on two separate connectors, and a dedicated connector for the pump. All exposed metal parts are titanium, instead of aluminum, for long life and minimum maintenance.

The 19plus can be operated without a computer from even the smallest boat, with data recorded in non-volatile FLASH memory and processed later on your PC. Simultaneous with recording, real-time data can be transmitted over single-core, armored cable directly to your PC's serial port (maximum transmission distance dependent on number of auxiliary sensors, baud rate, and cable properties). The 19plus' faster sampling and pump-controlled TC-ducted flow configuration significantly reduces salinity spiking caused by ship heave, and allows slower descent rates for improved resolution of water column features. Auxiliary sensors for dissolved oxygen, pH, turbidity, fluorescence, PAR, and ORP can be added, and for moored deployments the 19plus can be set to *time-series* mode using software commands. External power and two-way real-time communication over 10,000 meters of cable can be provided with the SBE 36 CTD Deck Unit and Power and Data Interface Module (PDIM).

The 19plus uses the same temperature and conductivity sensors proven in 5000 SEACAT and MicroCAT instruments, and a superior new micro-machined silicon strain gauge pressure sensor developed by Druck, Inc. Improvements in design, materials, and signal acquisition techniques yield a low-cost instrument with superior performance that is also easy to use. Calibration coefficients, obtained in our computer-controlled high-accuracy calibration baths, are stored in EEPROM memory. They permit data output in ASCII engineering units (degrees C, Siemens/m, decibars, Salinity [PSU], sound velocity [m/sec], etc.). The 19plus can be factory-configured to emulate the .hex output format and 2 Hz data rate of old SEACATs for compatibility with existing software or instrument fleets.

Accuracy, convenience, portability, software, and support; compelling reasons why the 19plus is today's best low-cost CTD.

### CONFIGURATION AND OPTIONS

A standard SBE 19plus is supplied with:

- Plastic housing for depths to 600 meters
- Strain-gauge pressure sensor
- 8 Mbyte FLASH RAM memory
- 9 D-size alkaline batteries
- Impulse glass-reinforced epoxy bulkhead connectors: 4-pin I/O, 2-pin pump, and two 6-pin (two differential auxiliary A/D inputs each)
- SBE 5M miniature pump and T-C Duct

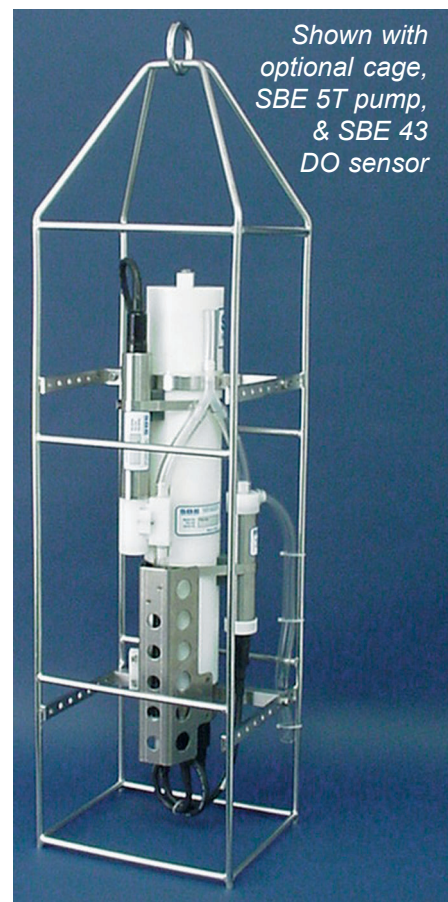
Options include:

- Titanium housing for depths to 7000 meters
- Sensors for oxygen, pH, fluorescence, light (PAR), light transmission, and turbidity
- SBE 5T pump in place of SBE 5M for use with dissolved oxygen and/or other pumped sensors
- Stainless steel cage
- MCBH *Micro* connectors
- Ni-Cad batteries and charger

### SOFTWARE

SEASOFT®-Win32, our complete Windows 95/98/NT/2000/XP software package, is included at no extra charge. Its modular programs include:

- SEATERM® — communication and data retrieval
- SEASAVE® — real-time data acquisition and display
- SBE Data Processing® — filtering, aligning, averaging, and plotting of CTD and auxiliary sensor data and derived variables



Shown with  
optional cage,  
SBE 5T pump,  
& SBE 43  
DO sensor



**Sea-Bird Electronics, Inc.**

1808 136th Place NE, Bellevue, Washington 98005 USA

Website: <http://www.seabird.com>

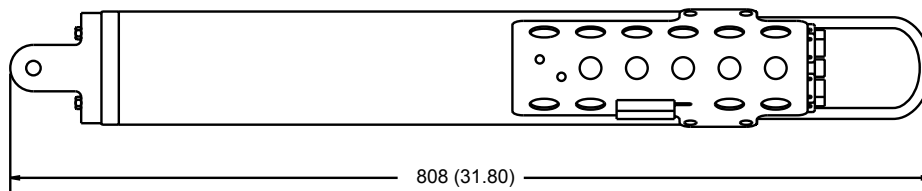
Email: [seabird@seabird.com](mailto:seabird@seabird.com)

Telephone: (425) 643-9866

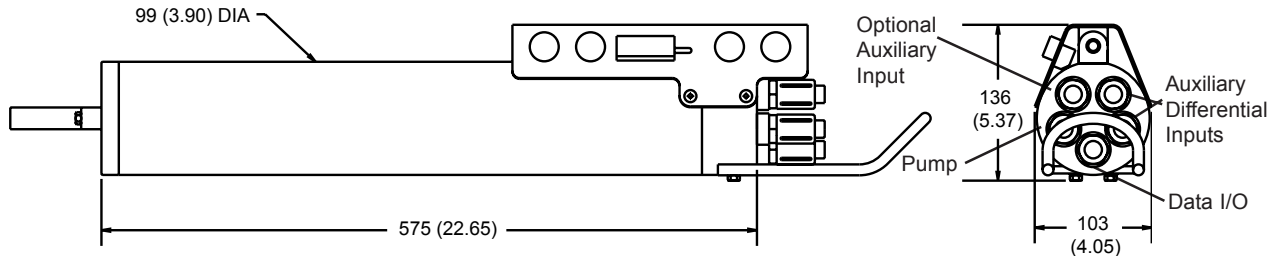
Fax: (425) 643-9954

# SEACAT Profiler

# SBE 19plus

Dimensions  
in millimeters  
(inches)



## SPECIFICATIONS

### Measurement Range

Temperature	-5 to +35 °C
Conductivity	0 to 9 S/m
Pressure	0 to 20 / 100 / 350 / 1000 / 2000 / 3500 / 7000 meters

### Initial Accuracy

Temperature	0.005 °C
Conductivity	0.0005 S/m
Pressure	0.1% of full scale range

### Typical Stability (per month)

Temperature	0.0002 °C
Conductivity	0.0003 S/m
Pressure	0.004% of full scale range

### Resolution

Temperature	0.0001 °C
Conductivity	0.00005 S/m (most oceanic waters; resolves 0.4 ppm in salinity)
	0.00007 S/m (high salinity waters; resolves 0.4 ppm in salinity)
	0.00001 S/m (fresh waters; resolves 0.1 ppm in salinity)
Pressure	0.002% of full scale range

### Memory

8 Mbyte non-volatile FLASH memory

### Data Storage

Recorded Parameter	Bytes/Sample
T + C	6
pressure	5
each external voltage	2

### Real-Time Clock

32,768 Hz TCXO accurate to ±1 minute/year

### Internal Batteries

9 alkaline D-cells provide 60 hours continuous CTD operation; optional 9-cell rechargeable nickel-cadmium battery pack provides approximately 24 hours operation per charge

### External Power Supply

9 - 28 VDC

### Power Requirements

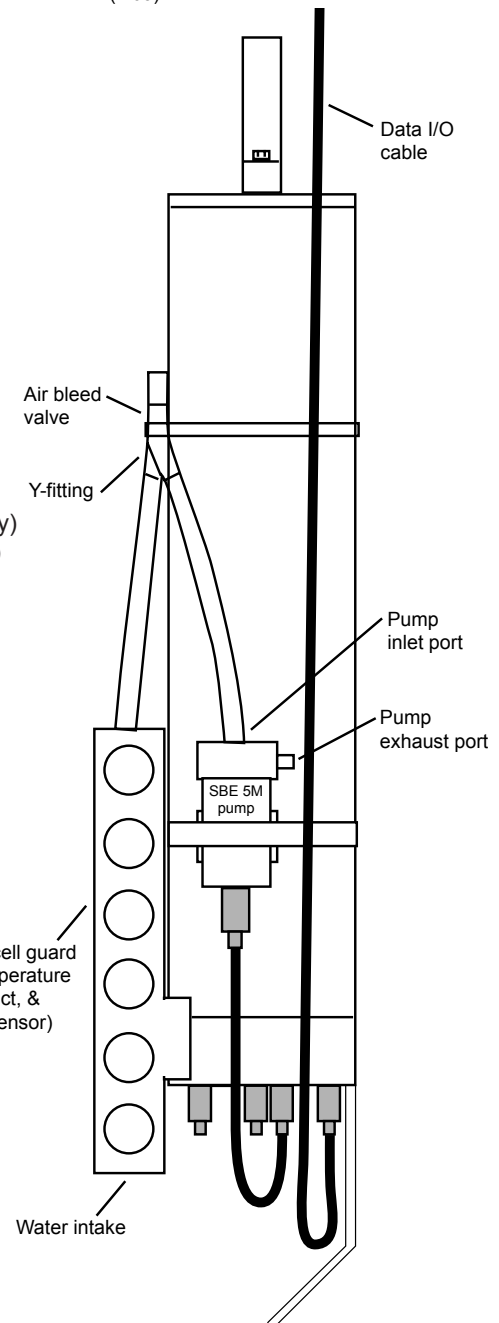
Sampling	65 mA
SBE 5M pump	95 mA
Quiescent	30 µA

### Auxiliary Voltage Sensors

Auxiliary power out	up to 500 mA at 10.5 - 11 VDC
A/D resolution	14 bits
Input range	0 - 5 VDC

### Housing Materials — Depth Rating — Weight

Acetal Copolymer Plastic housing — 600 meter (1950 feet) — 7.3 kg (16 lbs)  
3AL-2.5V Titanium housing — 7000 meter (22,900 feet) — 13.7 kg (30 lbs)



**Sea-Bird Electronics, Inc.**

1808 136th Place NE, Bellevue, Washington 98005 USA  
Website: <http://www.seabird.com>

Email: [seabird@seabird.com](mailto:seabird@seabird.com)  
Telephone: (425) 643-9866  
Fax: (425) 643-9954

# Mini Submersible Pump

## SBE 5M



The SBE 5M pump module consists of a centrifugal pump head and a long-life, DC ball bearing motor contained in a compact, titanium, pressure housing usable to 10,500 meters deep. The pump impeller and electric drive motor are coupled magnetically through the housing, providing high reliability by eliminating moving seals. Motor speed and pumping rate remain constant over the entire input voltage range. The motor drive electronics is intrinsically protected against accidental reversed polarity.

### APPLICATIONS

The SBE 5M is standard on the SBE 19 and 19*plus* SEACAT Profiler CTD. It is optional on the SBE 16, 16*plus*, and 16*plus*-IM SEACAT C-T Recorder. The pump flushes water through the conductivity cell at a constant rate, independent of the CTD's motion, improving dynamic performance. For applications requiring pumping through additional sensors (for example, a dissolved oxygen sensor), use the SBE 5T pump instead.

Specify:

- Option 5M-1 for profiling (continuous duty) applications such as the SBE 19*plus*.
- Option 5M-2 for moored (pulsed duty) applications such as the SBE 16*plus* or 16*plus*-IM.

Contact Sea-Bird for use in other applications.

### SPECIFICATIONS

#### Option 5M-1 (continuous duty):

**Input voltage range 9 - 18 VDC**

Flow Rate 25 ml/s                      supply current 95 ma

Note: Supply current is independent of operating voltage.

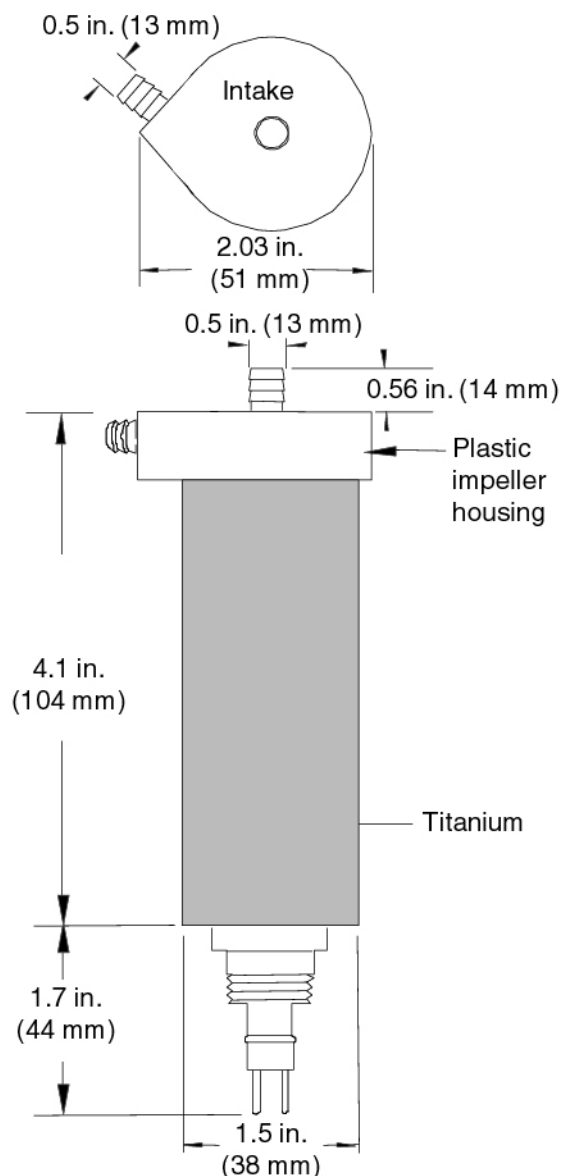
#### Option 5M-2 (pulsed duty):

**Input voltage range 6 - 18 VDC**

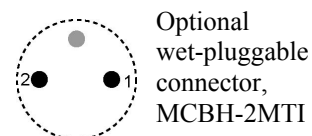
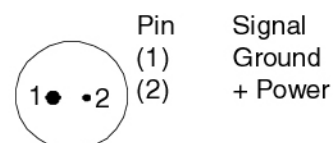
Pulse Duration	Flow Volume	Electrical Charge
0.5 seconds	15 ml	0.148 amp-seconds
1.0 seconds	21 ml	0.283 amp-seconds
1.5 seconds	31 ml	0.418 amp-seconds
2.0 seconds	40 ml	0.553 amp-seconds

#### Weight

In Air:                      0.42 kg (0.91 lbs)  
In Water:                    0.28 kg (0.60 lbs)



XSG-2BCL-HP-SS



06/03



Sea-Bird Electronics, Inc.

1808 136th Place NE, Bellevue, Washington 98005 USA

Website: <http://www.seabird.com>

FAX: (425) 643-9954

Tel: (425) 643-9866

Email: [seabird@seabird.com](mailto:seabird@seabird.com)

## SBE 5M MINI SUBMERSIBLE PUMP CONFIGURATION SHEET

Serial Number: 0649  
 Job Number: 36026  
 Customer: NOAA/PMC  
 Delivery Date: 6/14/2004

Single Connector Housing with Titanium screws

Pressure Case: 10,500 meters (titanium)

Maxon Motor Type:

P/N 90337, Motor PN 20130 (Low power 6 VDC, 2000 RPM MAX)

P/N 90335, Motor PN 20130 (Low power 9 VDC, 2000 RPM MAX)

Vin 15V voltage across C2: **7.947** VDC Current **11.8** mA

Vin 9V voltage across C2: **7.948** VDC Current **11.0** mA

Vin 6V voltage across C2: **5.868** VDC Current **10.2** mA

Pump submerged test, no load, Vin 12VDC Average current draw in water: **124** mA

# **SBE 19plusV2 SEACAT PROFILER**

*Conductivity, Temperature, and Pressure Recorder  
with RS-232 Interface*



**Serial Number: 19P50959-6121**

**User Manual, Version 002**

---

Sea-Bird Electronics, Inc.  
1808 136<sup>th</sup> Place NE  
Bellevue, Washington 98005 USA  
Tel: 425/643-9866  
Fax: 425/643-9954

## LIMITED LIABILITY STATEMENT

Extreme care should be exercised when using or servicing this equipment. It should be used or serviced only by personnel with knowledge of and training in the use and maintenance of oceanographic electronic equipment.

SEA-BIRD ELECTRONICS, INC. disclaims all product liability risks arising from the use or servicing of this system. SEA-BIRD ELECTRONICS, INC. has no way of controlling the use of this equipment or of choosing the personnel to operate it, and therefore cannot take steps to comply with laws pertaining to product liability, including laws which impose a duty to warn the user of any dangers involved in operating this equipment. Therefore, acceptance of this system by the customer shall be conclusively deemed to include a covenant by the customer to defend, indemnify, and hold SEA-BIRD ELECTRONICS, INC. harmless from all product liability claims arising from the use of servicing of this system.

## **WARNING !!**

**Do not submerge this instrument (S/N 19P50959-6121)  
beyond the depth rating of the lowest rated component listed below!**

<b>Main Housing (Plastic)</b>	<b>600 meters</b>
Pressure Sensor (600 dBar) Druck	600 meters
Pump (SBE 5M)	600 meters

# SYSTEM CONFIGURATION

30 September 2008

Model SBE 19plusV2	<b>S/N 19P50959-6121</b>
Instrument Type	<b>SBE 19plusV2 SeaCaT Profiler</b>
Firmware Version	<b>2.1</b>
Communications	<b>9600 baud, 8 data bits, no parity, one stop bit</b>
Memory	<b>64MB</b>
Housing	<b>600 meter (Acetron Plastic)</b>
0 Conductivity Raw Frequency	<b>3148.83 Hz</b>
Pressure Sensor	<b>Strain Gauge: 600 dBar, S/N 2752079</b>
Computer communications (Data I/O) connector	<b>Located on the P/N 17709 Y-Cable</b>
Number of Voltages Sampled:	<b>0</b>
Serial RS-232C Sensor	<b>None</b>
<b>Data Format:</b>	
Count	<b>Temperature</b>
Frequency	<b>Conductivity</b>
Count	<b>Pressure, Strain Gauge</b>
<b>Pump (SBE 5M)</b>	<b>051056</b>



## IMPORTANT SOFTWARE & HARDWARE CONFIGURATION INFORMATION

Sea-Bird supplies two versions of our software package for communication, real-time data acquisition, and data analysis and display:

- SEASOFT-Win32 - Windows software for PC running Win 95/98/NT/2000/XP
- SEASOFT-DOS - DOS software for IBM-PC/AT/386/486 or compatible computer with a hard drive

Detailed information on the use of the **Windows** software follows:

### SEASOFT-Win32

SEASOFT-Win32 software was supplied on a CD-ROM with your CTD. This software package is designed to run on a PC running Win 95/98/NT/2000/XP. The CD-ROM also contains software manuals that describe the appropriate applications for the various programs, the procedure for installing the software, and instructions on using the programs. There are three primary programs used with the CTD for setup, data collection and retrieval, data display, and data processing:

- SEATERM - terminal program for setup of the CTD and uploading of data from the CTD memory (**Note:** If using the CTD with the 90208 Auto Fire Module or SBE 17*plus* V2 SEARAM, use SeatermAF instead of SEATERM)
- SEASAVE - real-time data acquisition program
- SBE Data Processing - data processing program

Instructions for using the software are found in their Help files.

To communicate with the CTD to set it up or to upload data from the CTD memory to the computer hard drive, **SEATERM** must have information about the CTD hardware configuration (communication parameters, internal firmware, etc.) and about the computer. To communicate with the CTD, double click on Seaterm.exe:

1. In the Configure menu, select the CTD. The Configuration Options dialog box appears.
  - A. On the COM Settings tab, select the firmware version (if applicable), baud rate, data bits, and parity to match the CTD's configuration sheet. If necessary, change the com port to match the computer you are using.
  - B. On the Upload Settings tab, enter upload type (all as a single file, etc.) as desired.  
*For the SBE 17 and 25 only:* enter the serial number for the SBE 3 (temperature) and SBE 4 (conductivity) modular sensors, exactly as they appear in the configuration (.con) file.
  - C. On the Header Information tab, change the settings as desired.
 Click OK when done. SEATERM saves the settings in a SEATERM.ini file.
2. On the Toolbar, click Connect to communicate with the CTD.
3. To set up the CTD prior to deployment:  
On the Toolbar, click Status. SEATERM sends the Status command and displays the response. Verify that the CTD setup matches your desired deployment. If not, send commands to modify the setup.
4. To upload data from the CTD:  
On the Toolbar, click Upload to upload data from the CTD memory to the computer.

Sea-Bird CTDs store and/or transmit data from their primary and auxiliary sensors in the form of binary or hexadecimal number equivalents of the sensors' frequency or voltage outputs. This is referred to as the *raw* data. The calculations required to convert from *raw* data to *engineering* units of the measured parameters (temperature, conductivity, pressure, dissolved oxygen, pH, etc.) are performed using the software, either in real time, or after the data has been stored in a file. SEASAVE creates the file in real time. As noted above, SEATERM uploads the recorded data and creates the file on the computer hard drive.

To successfully store data to a file on the computer and subsequently convert it to engineering units, the software must know the CTD type, CTD configuration, and calibration coefficients for the sensors installed on the CTD. This information is unique to each CTD, and is contained in a *configuration* file. The configuration file, which has a .con extension, was written onto a floppy disk and the CD-ROM shipped with the CTD. The .con file for a given CTD is named with the last four digits of the serial number for that CTD (e.g., 1234.con). The configuration file is created or modified (e.g., changing coefficients after recalibration, or adding another sensor) by using the Configure menu in **SEASAVE** or

**SBE Data Processing.** The configuration file is used by SEASAVE to convert raw data to engineering units when it acquires, stores, and displays real-time data. The configuration file is also used by some modules in SBE Data Processing (Data Conversion and Derive) that convert raw data to engineering units during data processing.

The instrument type and instrument configuration settings of the .con file and the required setup for the SEATERM.ini file for the CTD *as delivered* are documented below. The calibration coefficients for the CTD's sensors are contained in the calibration coefficient section of the CTD manual.

**NOTE:**

SEATERM will not upload data correctly without a properly configured SEATERM.ini file. SEASAVE and SBE Data Processing will not interpret the data correctly without the correct .con file.

**SEASOFT CONFIGURATION:**

The correct instrument type for your instrument is SBE 19plus V2 SEACAT Profiler. The correct settings for the configuration of your instrument as delivered are documented below:

Configuration for the SBE 19plus V2 Sea... ✖

Configuration file opened: None

Pressure sensor type: Strain Gauge

External voltage channels: 0

Mode: Profile

Serial RS-232C sensor: None

Sample interval seconds: 10

Scans to average: 1

Surface PAR voltage added     Scan time added

NMEA position data added     NMEA depth data added

Channel	Sensor
1. Count	Temperature
2. Frequency	Conductivity
3. Count	Pressure, Strain Gauge

New    Open...    Save    Save As...    Select...    Modify...

Report...    Help...    Exit    Cancel

# SPECIFICATIONS

SBE 19plus-V2 Specifications.....	1
SBE 5M Pump.....	3

# SEACAT Profiler CTD

## SBE 19plus V2



The SBE 19plus V2 (Version 2) Seacat Profiler CTD measures conductivity, temperature, and pressure (depth) and provides high accuracy and resolution, reliability, and ease-of-use for a wide range of research, monitoring, and engineering applications. The pump-controlled, T-C ducted flow configuration minimizes salinity spiking caused by ship heave and allows for slow descent rates without slowing sensor responses, improving dynamic accuracy and resolving small scale structure in the water column. The V2 is the most versatile successor in the line of *Personal CTDs* begun with the original SBE 19 SEACAT in 1987.

Compared to the previous 19plus, the 19plus V2 incorporates an electronics upgrade and additional features. The V2 has two additional (6 total) auxiliary A/D input channels, FLASH memory is increased from 8 to 64 MB, and one RS-232 data input channel is added. An optional Digiquartz® pressure sensor provides highest-accuracy pressure measurement. Data can be output in XML as well as ASCII and HEX formats. Firmware upgrades can be downloaded through the communications port by the user, without opening the instrument.

The 19plus V2 samples continuously at up to 4 scans per second (4 Hz) (2 Hz with Digiquartz®), is battery-powered and self-recording, and is commonly used in the field without a computer, recording up to 1000 individual profiles. Data can be uploaded to a PC and processed later, or can typically be transmitted in real time more than 100 meters to a PC for acquisition and display using SEASOFT software provided (maximum cable length is dependent on the number of auxiliary sensors, sampling rate, baud rate, and cable properties). The 19plus V2 can supply power to 7 external sensors and log their outputs with each CTD scan. Nine D-size alkaline batteries provide up to 60 hours of continuous operation when logging C, T, and P at 4 Hz (operation time is shorter if powering auxiliary sensors).

The 19plus V2 is easily integrated with an SBE 32 Carousel Water Sampler and is ideal for integration with the SBE 55 ECO Water Sampler. Both real-time and autonomous *auto-fire* operations are possible with any Sea-Bird CTD / Water Sampler system.

The 19plus V2 can operate in moored mode, recording time series measurements at user-programmable intervals. Moored mode is easily configured using setup commands and by removing the profiling T-C Duct and installing optional anti-fouling devices. (If profiling is not needed, the 16plus V2 Seacat Recorder offers greater moored-mode programming flexibility and a pressure sensor is optional.)

Accuracy, convenience, portability, software, and support: compelling reasons why the 19plus V2 is today's best low-cost CTD.

### CONFIGURATION, OPTIONS, AND ACCESSORIES

A standard SBE 19plus V2 is supplied with:

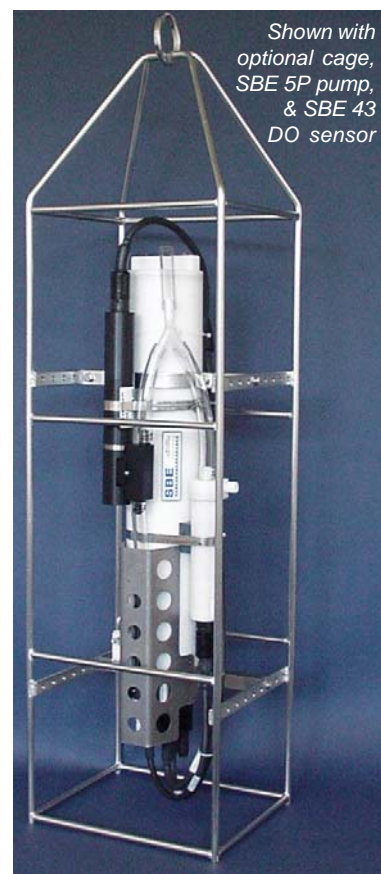
- Plastic housing for depths to 600 meters
- Strain-gauge pressure sensor
- 64 Mbyte FLASH RAM memory
- 9 D-size alkaline batteries
- Glass-reinforced epoxy bulkhead connectors
- SBE 5M miniature pump with plastic housing for depths to 600 m, and T-C Duct

Options and accessories include:

- Titanium housing for depths to 7000 meters
- Wet-pluggable MCBH series connectors
- SBE 5M miniature pump with titanium housing for 7000 meters
- SBE 5P (plastic) or 5T (titanium) in place of SBE 5M for use with dissolved oxygen and/or other pumped sensors
- Digiquartz® pressure sensor
- Stainless steel protection cage
- Auxiliary sensors for Dissolved Oxygen, pH (Profiling mode only), fluorescence, radiance (PAR), light transmission, and optical backscatter (turbidity)
- Plastic shipping case
- Nickel Metal Hydride (NiMH) batteries and charger
- Moored mode conversion kit with anti-foulant device fittings
- Load-bearing underwater cables for hand-hauled, real-time profiling
- SBE 36 CTD Deck Unit and Power/Data Interface Module (PDIM) for real-time operation on single-core armored cable up to 10,000 meters

### SOFTWARE

The SBE 19plus V2 is supplied with a powerful Windows 2000/XP software package, SEASOFT®-Win32, which includes programs for communication and data retrieval, real-time data acquisition and display, and data processing (filtering, aligning, averaging) and plotting.



**Sea-Bird Electronics, Inc.**

1808 136th Place NE, Bellevue, Washington 98005 USA

Website: <http://www.seabird.com>

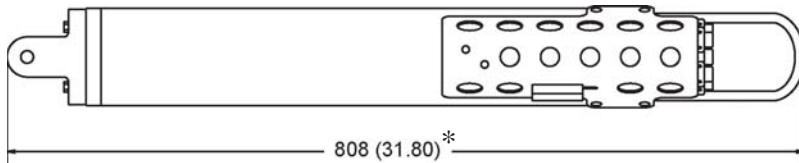
E-mail: [seabird@seabird.com](mailto:seabird@seabird.com)

Telephone: (425) 643-9866

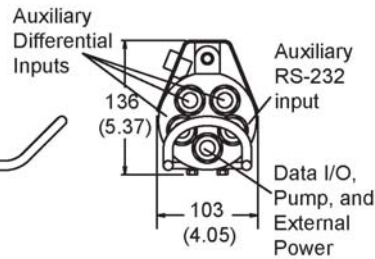
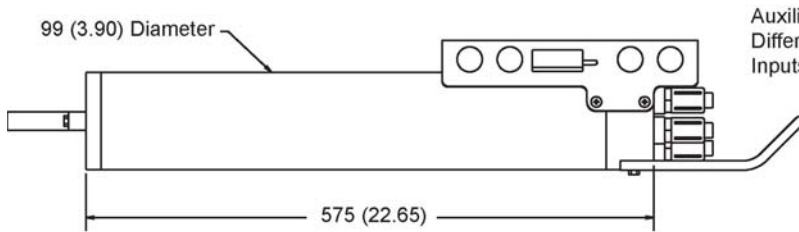
Fax: (425) 643-9954

# SEACAT Profiler CTD

## SBE 19plus V2

\*Note: 19plus V2 with optional Quartz pressure sensor is 190 mm (7.5 inches) longer than shown in drawing.



Dimensions  
in millimeters  
(inches)

	Measurement Range	Initial Accuracy	Typical Stability	Resolution
<b>Conductivity (S/m)</b>	0 to 9	0.0005	0.0003/month	0.00005 (most oceanic waters; resolves 0.4 ppm in salinity) 0.00007 S/m (high salinity waters; resolves 0.4 ppm in salinity) 0.00001 S/m (fresh waters; resolves 0.1 ppm in salinity)
<b>Temperature (°C)</b>	-5 to +35	0.005	0.0002/month	0.0001
<b>Pressure - Strain Gauge</b>	0 to 20/100/350/600/ 1000/2000/3500/ 7000 meters	0.1% of full scale range	0.1% of full scale range/year	0.002% of full scale range
<b>Pressure - Quartz</b>	0 to 20/60/130/200/ 270/680/1400/ 2000/4200/7000/ 10,500 meters	0.02% of full scale range	0.025% of full scale range/year	0.0025% of full scale range

**Memory** 64 Mbyte non-volatile FLASH memory

**Data Storage**

Recorded Parameter	Bytes/Sample
T + C	6
pressure - strain gauge or Quartz	5
each external voltage	2
auxiliary RS-232 sensor	sensor dependent

**Real-Time Clock** 32,768 Hz TCXO accurate to ±1 minute/year

**Internal Batteries** 9 alkaline D-cells (Duracell MN1300, LR20) provide 60 hours profiling; optional 9-cell NiMH battery pack provides 40 hours profiling per charge; optional 9-cell Ni-Cad battery pack provides 24 hours profiling per charge

**External Power Supply** 9 - 28 VDC; consult factory for required current

### Power Requirements

Sampling	70 mA	
Pump	SBE 5M: 100 mA	Optional SBE 5T or 5P: 150 mA
Communications	65 mA	
Quiescent	20 µA	

### Auxiliary Sensors

Auxiliary power out	up to 500 mA at 10.5 - 11 VDC
Voltage sensor A/D resolution	14 bits
Voltage sensor input range	0 - 5 VDC

### Housing Materials, Depth Rating, Weight in air\*, Weight in water\*

Acetal Copolymer Plastic housing, 600 m (1950 ft), 7.3 kg (16 lbs), 2.3 kg (5 lbs)

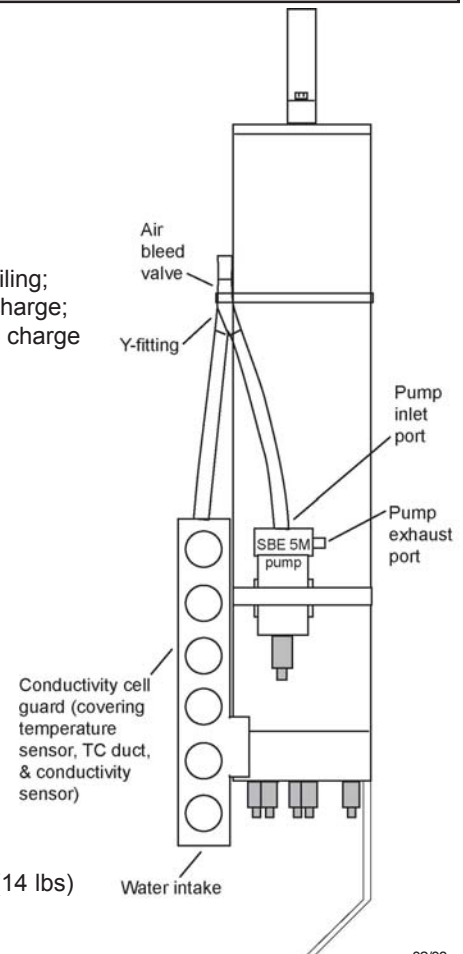
3AL-2.5V Titanium housing, 7000 m (22,900 ft), 13.7 kg (30 lbs), 8.6 kg (19 lbs)

\*Weights listed are without pump; pump adds (in air) 0.3 to 0.7 kg (0.6 to 1.5 lbs), depending on pump model selected. See pump brochures for details.

### Optional Cage

(for 19plus V2 with strain-gauge pressure) 1016 x 241 x 279 mm (40 x 9.5 x 11 in.), 6.3 kg (14 lbs)

(for 19plus V2 with Digiquartz pressure) 1219 x 241 x 279 mm (48 x 9.5 x 11 in.)



02/08



**Sea-Bird Electronics, Inc.**

1808 136th Place NE, Bellevue, Washington 98005 USA

Website: <http://www.seabird.com>

E-mail: [seabird@seabird.com](mailto:seabird@seabird.com)

Telephone: (425) 643-9866

Fax: (425) 643-9954

# Mini Submersible Pump

## SBE 5M



The SBE 5M pump module consists of a centrifugal pump head and a long-life, DC, ball-bearing motor contained in a compact, titanium pressure housing usable to 10,500 meters (34,400 ft) deep. A plastic housing for depths to 600 meters (1960 ft) is available as an option. The pump impeller and electric drive motor are coupled magnetically through the housing, providing high reliability by eliminating moving seals. Motor speed and pumping rate remain constant over the entire input voltage range. The motor drive electronics is intrinsically protected against accidental reversed polarity.

## APPLICATIONS

The SBE 5M is standard on the SBE 19*plus* V2 SEACAT Profiler CTD, and is optional on the SBE 16*plus* V2 and 16*plus*-IM V2 SEACAT C-T Recorders. The pump flushes water through the conductivity cell at a constant rate, independent of the CTD's motion, improving dynamic performance. For applications requiring pumping through additional sensors (for example, a dissolved oxygen sensor), use the SBE 5T or 5P pump instead.

Specify:

- Option **5M-1** for profiling (continuous duty) applications such as the SBE 19*plus* V2.
- Option **5M-2** for moored (pulsed duty) applications such as the SBE 16*plus* V2 or 16*plus*-IM V2.

Contact Sea-Bird for use in other applications.

## SPECIFICATIONS

**Option 5M-1 (continuous duty):**  
Input voltage range 9 - 18 VDC

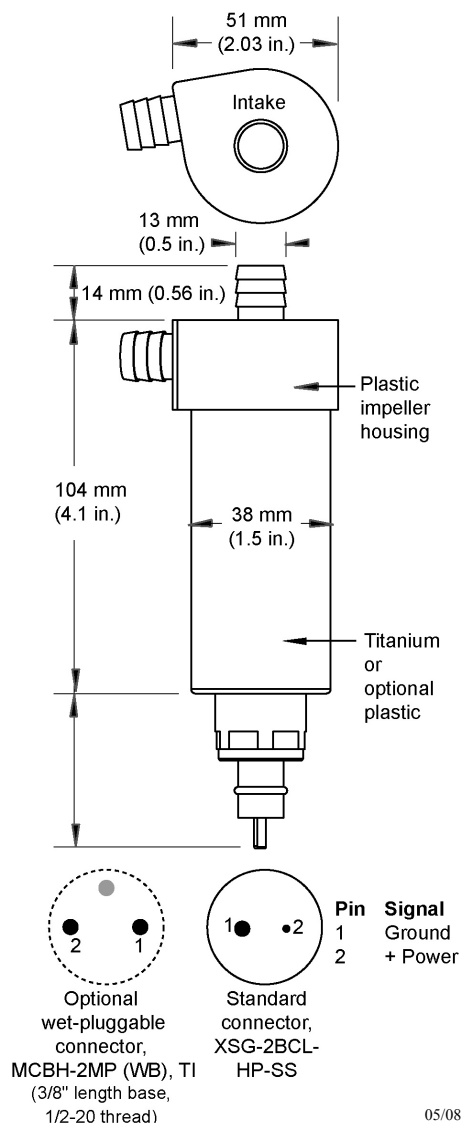
Flow Rate 25 ml/s                      Supply current 95 mA  
*Note: Supply current is independent of operating voltage.*

**Option 5M-2 (pulsed duty):**  
Input voltage range 6 - 18 VDC

Pulse Duration	Flow Volume	Electrical Charge
0.5 seconds	15 ml	0.148 Amp-seconds
1.0 seconds	21 ml	0.283 Amp-seconds
1.5 seconds	31 ml	0.418 Amp-seconds
2.0 seconds	40 ml	0.553 Amp-seconds

## Weight

With standard **titanium** housing:  
In Air - 0.42 kg (0.91 lbs); In Water - 0.28 kg (0.60 lbs)  
With optional **plastic** housing:  
In Air - 0.28 kg (0.60 lbs); In Water - 0.13 kg (0.29 lbs)





Sea-Bird Electronics, Inc.

1808 136th Place NE, Bellevue, Washington 98005 USA  
 Website: <http://www.seabird.com>

FAX: (425) 643-9954

Tel: (425) 643-9866  
 Email: [seabird@seabird.com](mailto:seabird@seabird.com)

## SBE 5M MINI SUBMERSIBLE PUMP CONFIGURATION SHEET

Serial Number: **1056**

Job Number: **50959**

Customer: **NOAA/PMC**

Delivery Date: **10/3/2008**

Single Bulkhead Connector.

Pressure Case: 10,500 meters (titanium)

Maxon Motor Type:

**P/N 801605, Motor PN 20130 (Pulsed Duty 6 VDC, 2000 RPM MAX)**

**P/N 801606, Motor PN 20127 (Continuous Duty 9 VDC, 2000 RPM MAX)**

Vin 15V voltage across C2: **7.96** VDC Current **15.8** mA

Vin 9V voltage across C2: **7.96** VDC Current **15.7** mA

Vin 6V voltage across C2: **5.9** VDC Current **10.4** mA

Pump submerged test, no load, Vin 12VDC Average current draw in water: **120** mA

# **SBE 19plusV2 SEACAT PROFILER**

*Conductivity, Temperature, and Pressure Recorder  
with RS-232 Interface*



**Serial Number: 19P50959-6122**

**User Manual, Version 002**

---

Sea-Bird Electronics, Inc.  
1808 136<sup>th</sup> Place NE  
Bellevue, Washington 98005 USA  
Tel: 425/643-9866  
Fax: 425/643-9954



## LIMITED LIABILITY STATEMENT

Extreme care should be exercised when using or servicing this equipment. It should be used or serviced only by personnel with knowledge of and training in the use and maintenance of oceanographic electronic equipment.

SEA-BIRD ELECTRONICS, INC. disclaims all product liability risks arising from the use or servicing of this system. SEA-BIRD ELECTRONICS, INC. has no way of controlling the use of this equipment or of choosing the personnel to operate it, and therefore cannot take steps to comply with laws pertaining to product liability, including laws which impose a duty to warn the user of any dangers involved in operating this equipment. Therefore, acceptance of this system by the customer shall be conclusively deemed to include a covenant by the customer to defend, indemnify, and hold SEA-BIRD ELECTRONICS, INC. harmless from all product liability claims arising from the use of servicing of this system.

## **WARNING !!**

**Do not submerge this instrument (S/N 19P50959-6122)  
beyond the depth rating of the lowest rated component listed below!**

<b>Main Housing (Plastic)</b>	<b>600 meters</b>
Pressure Sensor (600 dBar) Druck	600 meters
Pump (SBE 5M)	600 meters

# SYSTEM CONFIGURATION

1 October 2008

Model SBE 19plusV2	<b>S/N 19P50959-6122</b>
Instrument Type	<b>SBE 19plusV2 SeaCaT Profiler</b>
Firmware Version	<b>2.1</b>
Communications	<b>9600 baud, 8 data bits, no parity, one stop bit</b>
Memory	<b>64MB</b>
Housing	<b>600 meter (Acetron Plastic)</b>
0 Conductivity Raw Frequency	<b>2523.44 Hz</b>
Pressure Sensor	<b>Strain Gauge: 600 dBar, S/N 2752080</b>
Computer communications (Data I/O) connector	<b>Located on the P/N 17709 Y-Cable</b>
Number of Voltages Sampled:	<b>0</b>
Serial RS-232C Sensor	<b>None</b>
<b>Data Format:</b>	
Count	<b>Temperature</b>
Frequency	<b>Conductivity</b>
Count	<b>Pressure, Strain Gauge</b>
<b>Pump (SBE 5M)</b>	<b>051058</b>

## IMPORTANT SOFTWARE & HARDWARE CONFIGURATION INFORMATION

Sea-Bird supplies two versions of our software package for communication, real-time data acquisition, and data analysis and display:

- SEASOFT-Win32 - Windows software for PC running Win 95/98/NT/2000/XP
- SEASOFT-DOS - DOS software for IBM-PC/AT/386/486 or compatible computer with a hard drive

Detailed information on the use of the **Windows** software follows:

### SEASOFT-Win32

SEASOFT-Win32 software was supplied on a CD-ROM with your CTD. This software package is designed to run on a PC running Win 95/98/NT/2000/XP. The CD-ROM also contains software manuals that describe the appropriate applications for the various programs, the procedure for installing the software, and instructions on using the programs. There are three primary programs used with the CTD for setup, data collection and retrieval, data display, and data processing:

- SEATERM - terminal program for setup of the CTD and uploading of data from the CTD memory (**Note:** If using the CTD with the 90208 Auto Fire Module or SBE 17*plus* V2 SEARAM, use SeatermAF instead of SEATERM)
- SEASAVE - real-time data acquisition program
- SBE Data Processing - data processing program

Instructions for using the software are found in their Help files.

To communicate with the CTD to set it up or to upload data from the CTD memory to the computer hard drive, **SEATERM** must have information about the CTD hardware configuration (communication parameters, internal firmware, etc.) and about the computer. To communicate with the CTD, double click on Seaterm.exe:

1. In the Configure menu, select the CTD. The Configuration Options dialog box appears.
  - A. On the COM Settings tab, select the firmware version (if applicable), baud rate, data bits, and parity to match the CTD's configuration sheet. If necessary, change the com port to match the computer you are using.
  - B. On the Upload Settings tab, enter upload type (all as a single file, etc.) as desired.  
*For the SBE 17 and 25 only:* enter the serial number for the SBE 3 (temperature) and SBE 4 (conductivity) modular sensors, exactly as they appear in the configuration (.con) file.
  - C. On the Header Information tab, change the settings as desired.
 Click OK when done. SEATERM saves the settings in a SEATERM.ini file.
2. On the Toolbar, click Connect to communicate with the CTD.
3. To set up the CTD prior to deployment:  
 On the Toolbar, click Status. SEATERM sends the Status command and displays the response. Verify that the CTD setup matches your desired deployment. If not, send commands to modify the setup.
4. To upload data from the CTD:  
 On the Toolbar, click Upload to upload data from the CTD memory to the computer.

Sea-Bird CTDs store and/or transmit data from their primary and auxiliary sensors in the form of binary or hexadecimal number equivalents of the sensors' frequency or voltage outputs. This is referred to as the *raw* data. The calculations required to convert from *raw* data to *engineering* units of the measured parameters (temperature, conductivity, pressure, dissolved oxygen, pH, etc.) are performed using the software, either in real time, or after the data has been stored in a file. SEASAVE creates the file in real time. As noted above, SEATERM uploads the recorded data and creates the file on the computer hard drive.

To successfully store data to a file on the computer and subsequently convert it to engineering units, the software must know the CTD type, CTD configuration, and calibration coefficients for the sensors installed on the CTD. This information is unique to each CTD, and is contained in a *configuration* file. The configuration file, which has a .con extension, was written onto a floppy disk and the CD-ROM shipped with the CTD. The .con file for a given CTD is named with the last four digits of the serial number for that CTD (e.g., 1234.con). The configuration file is created or modified (e.g., changing coefficients after recalibration, or adding another sensor) by using the Configure menu in **SEASAVE** or

**SBE Data Processing.** The configuration file is used by SEASAVE to convert raw data to engineering units when it acquires, stores, and displays real-time data. The configuration file is also used by some modules in SBE Data Processing (Data Conversion and Derive) that convert raw data to engineering units during data processing.


The instrument type and instrument configuration settings of the .con file and the required setup for the SEATERM.ini file for the CTD *as delivered* are documented below. The calibration coefficients for the CTD's sensors are contained in the calibration coefficient section of the CTD manual.

**NOTE:**

SEATERM will not upload data correctly without a properly configured SEATERM.ini file. SEASAVE and SBE Data Processing will not interpret the data correctly without the correct .con file.

**SEASOFT CONFIGURATION:**

The correct instrument type for your instrument is SBE 19plus V2 SEACAT Profiler. The correct settings for the configuration of your instrument as delivered are documented below:

Configuration for the SBE 19plus V2 Sea... 

Configuration file opened: None

Pressure sensor type:

External voltage channels:

Mode:

Serial RS-232C sensor:

Sample interval seconds:

Scans to average:

Surface PAR voltage added       Scan time added

NMEA position data added       NMEA depth data added

Channel	Sensor
1. Count	Temperature
2. Frequency	Conductivity
3. Count	Pressure, Strain Gauge

New  
Open...  
Save  
Save As...  
Select...  
Modify...

Report...      Help...      Exit      Cancel

# SPECIFICATIONS

SBE 19plus-V2 Specifications.....	1
SBE 5M Pump.....	3

# SEACAT Profiler CTD

## SBE 19plus V2



The SBE 19plus V2 (Version 2) Seacat Profiler CTD measures conductivity, temperature, and pressure (depth) and provides high accuracy and resolution, reliability, and ease-of-use for a wide range of research, monitoring, and engineering applications. The pump-controlled, T-C ducted flow configuration minimizes salinity spiking caused by ship heave and allows for slow descent rates without slowing sensor responses, improving dynamic accuracy and resolving small scale structure in the water column. The V2 is the most versatile successor in the line of *Personal CTDs* begun with the original SBE 19 SEACAT in 1987.

Compared to the previous 19plus, the 19plus V2 incorporates an electronics upgrade and additional features. The V2 has two additional (6 total) auxiliary A/D input channels, FLASH memory is increased from 8 to 64 MB, and one RS-232 data input channel is added. An optional Digiquartz® pressure sensor provides highest-accuracy pressure measurement. Data can be output in XML as well as ASCII and HEX formats. Firmware upgrades can be downloaded through the communications port by the user, without opening the instrument.

The 19plus V2 samples continuously at up to 4 scans per second (4 Hz) (2 Hz with Digiquartz®), is battery-powered and self-recording, and is commonly used in the field without a computer, recording up to 1000 individual profiles. Data can be uploaded to a PC and processed later, or can typically be transmitted in real time more than 100 meters to a PC for acquisition and display using SEASOFT software provided (maximum cable length is dependent on the number of auxiliary sensors, sampling rate, baud rate, and cable properties). The 19plus V2 can supply power to 7 external sensors and log their outputs with each CTD scan. Nine D-size alkaline batteries provide up to 60 hours of continuous operation when logging C, T, and P at 4 Hz (operation time is shorter if powering auxiliary sensors).

The 19plus V2 is easily integrated with an SBE 32 Carousel Water Sampler and is ideal for integration with the SBE 55 ECO Water Sampler. Both real-time and autonomous *auto-fire* operations are possible with any Sea-Bird CTD / Water Sampler system.

The 19plus V2 can operate in moored mode, recording time series measurements at user-programmable intervals. Moored mode is easily configured using setup commands and by removing the profiling T-C Duct and installing optional anti-fouling devices. (If profiling is not needed, the 16plus V2 Seacat Recorder offers greater moored-mode programming flexibility and a pressure sensor is optional.)

Accuracy, convenience, portability, software, and support: compelling reasons why the 19plus V2 is today's best low-cost CTD.

### CONFIGURATION, OPTIONS, AND ACCESSORIES

A standard SBE 19plus V2 is supplied with:

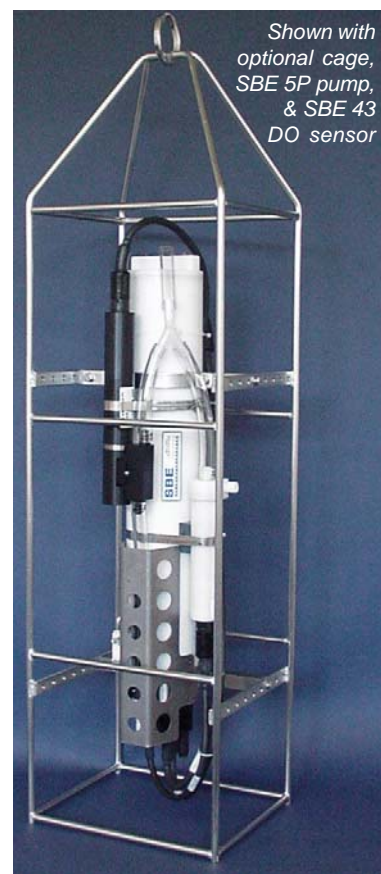
- Plastic housing for depths to 600 meters
- Strain-gauge pressure sensor
- 64 Mbyte FLASH RAM memory
- 9 D-size alkaline batteries
- Glass-reinforced epoxy bulkhead connectors
- SBE 5M miniature pump with plastic housing for depths to 600 m, and T-C Duct

Options and accessories include:

- Titanium housing for depths to 7000 meters
- Wet-pluggable MCBH series connectors
- SBE 5M miniature pump with titanium housing for 7000 meters
- SBE 5P (plastic) or 5T (titanium) in place of SBE 5M for use with dissolved oxygen and/or other pumped sensors
- Digiquartz® pressure sensor
- Stainless steel protection cage
- Auxiliary sensors for Dissolved Oxygen, pH (Profiling mode only), fluorescence, radiance (PAR), light transmission, and optical backscatter (turbidity)
- Plastic shipping case
- Nickel Metal Hydride (NiMH) batteries and charger
- Moored mode conversion kit with anti-foulant device fittings
- Load-bearing underwater cables for hand-hauled, real-time profiling
- SBE 36 CTD Deck Unit and Power/Data Interface Module (PDIM) for real-time operation on single-core armored cable up to 10,000 meters

### SOFTWARE

The SBE 19plus V2 is supplied with a powerful Windows 2000/XP software package, SEASOFT®-Win32, which includes programs for communication and data retrieval, real-time data acquisition and display, and data processing (filtering, aligning, averaging) and plotting.



**Sea-Bird Electronics, Inc.**

1808 136th Place NE, Bellevue, Washington 98005 USA

Website: <http://www.seabird.com>

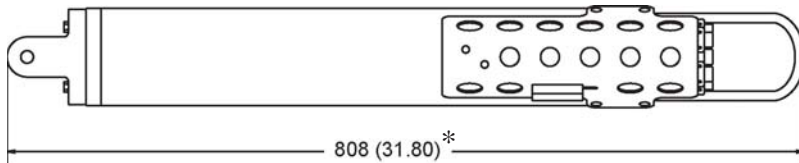
E-mail: [seabird@seabird.com](mailto:seabird@seabird.com)

Telephone: (425) 643-9866

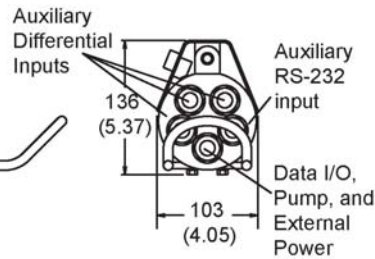
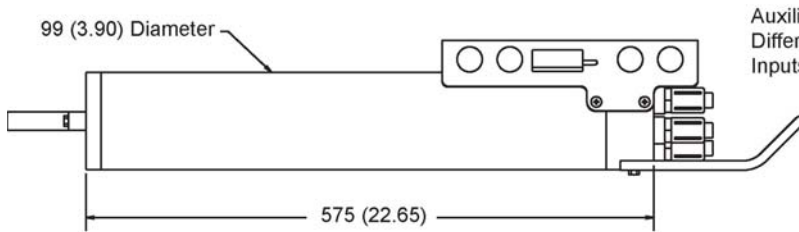
Fax: (425) 643-9954

# SEACAT Profiler CTD

## SBE 19plus V2

\*Note: 19plus V2 with optional Quartz pressure sensor is 190 mm (7.5 inches) longer than shown in drawing.



Dimensions  
in millimeters  
(inches)

	Measurement Range	Initial Accuracy	Typical Stability	Resolution
<b>Conductivity (S/m)</b>	0 to 9	0.0005	0.0003/month	0.00005 (most oceanic waters; resolves 0.4 ppm in salinity) 0.00007 S/m (high salinity waters; resolves 0.4 ppm in salinity) 0.00001 S/m (fresh waters; resolves 0.1 ppm in salinity)
<b>Temperature (°C)</b>	-5 to +35	0.005	0.0002/month	0.0001
<b>Pressure - Strain Gauge</b>	0 to 20/100/350/600/ 1000/2000/3500/ 7000 meters	0.1% of full scale range	0.1% of full scale range/year	0.002% of full scale range
<b>Pressure - Quartz</b>	0 to 20/60/130/200/ 270/680/1400/ 2000/4200/7000/ 10,500 meters	0.02% of full scale range	0.025% of full scale range/year	0.0025% of full scale range

**Memory** 64 Mbyte non-volatile FLASH memory

**Data Storage**

Recorded Parameter	Bytes/Sample
T + C	6
pressure - strain gauge or Quartz	5
each external voltage	2
auxiliary RS-232 sensor	sensor dependent

**Real-Time Clock** 32,768 Hz TCXO accurate to ±1 minute/year

**Internal Batteries** 9 alkaline D-cells (Duracell MN1300, LR20) provide 60 hours profiling; optional 9-cell NiMH battery pack provides 40 hours profiling per charge; optional 9-cell Ni-Cad battery pack provides 24 hours profiling per charge

**External Power Supply** 9 - 28 VDC; consult factory for required current

### Power Requirements

Sampling	70 mA	
Pump	SBE 5M: 100 mA	Optional SBE 5T or 5P: 150 mA
Communications	65 mA	
Quiescent	20 µA	

### Auxiliary Sensors

Auxiliary power out	up to 500 mA at 10.5 - 11 VDC
Voltage sensor A/D resolution	14 bits
Voltage sensor input range	0 - 5 VDC

### Housing Materials, Depth Rating, Weight in air\*, Weight in water\*

Acetal Copolymer Plastic housing, 600 m (1950 ft), 7.3 kg (16 lbs), 2.3 kg (5 lbs)

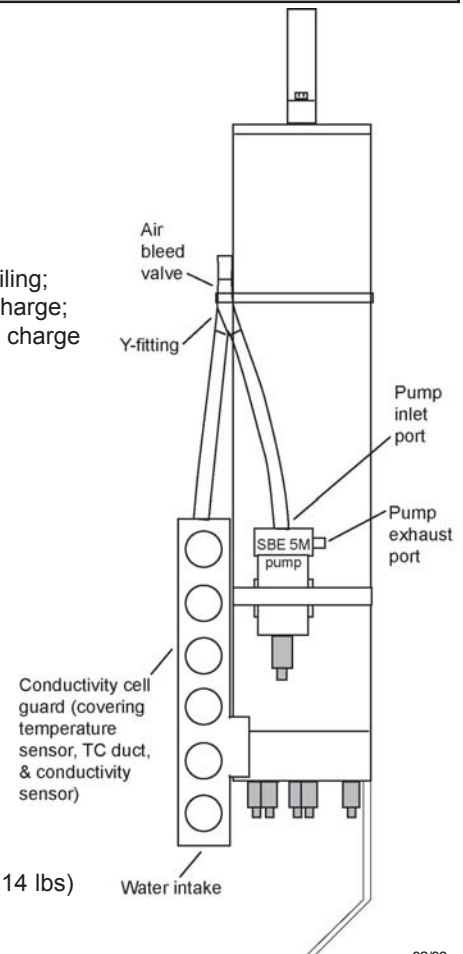
3AL-2.5V Titanium housing, 7000 m (22,900 ft), 13.7 kg (30 lbs), 8.6 kg (19 lbs)

\*Weights listed are without pump; pump adds (in air) 0.3 to 0.7 kg (0.6 to 1.5 lbs), depending on pump model selected. See pump brochures for details.

### Optional Cage

(for 19plus V2 with strain-gauge pressure) 1016 x 241 x 279 mm (40 x 9.5 x 11 in.), 6.3 kg (14 lbs)

(for 19plus V2 with Digiquartz pressure) 1219 x 241 x 279 mm (48 x 9.5 x 11 in.)



02/08



**Sea-Bird Electronics, Inc.**

1808 136th Place NE, Bellevue, Washington 98005 USA

Website: <http://www.seabird.com>

E-mail: [seabird@seabird.com](mailto:seabird@seabird.com)

Telephone: (425) 643-9866

Fax: (425) 643-9954



# Mini Submersible Pump

## SBE 5M



The SBE 5M pump module consists of a centrifugal pump head and a long-life, DC, ball-bearing motor contained in a compact, titanium pressure housing usable to 10,500 meters (34,400 ft) deep. A plastic housing for depths to 600 meters (1960 ft) is available as an option. The pump impeller and electric drive motor are coupled magnetically through the housing, providing high reliability by eliminating moving seals. Motor speed and pumping rate remain constant over the entire input voltage range. The motor drive electronics is intrinsically protected against accidental reversed polarity.

## APPLICATIONS

The SBE 5M is standard on the SBE 19*plus* V2 SEACAT Profiler CTD, and is optional on the SBE 16*plus* V2 and 16*plus*-IM V2 SEACAT C-T Recorders. The pump flushes water through the conductivity cell at a constant rate, independent of the CTD's motion, improving dynamic performance. For applications requiring pumping through additional sensors (for example, a dissolved oxygen sensor), use the SBE 5T or 5P pump instead.

Specify:

- Option **5M-1** for profiling (continuous duty) applications such as the SBE 19*plus* V2.
- Option **5M-2** for moored (pulsed duty) applications such as the SBE 16*plus* V2 or 16*plus*-IM V2.

Contact Sea-Bird for use in other applications.

## SPECIFICATIONS

**Option 5M-1 (continuous duty):**  
Input voltage range 9 - 18 VDC

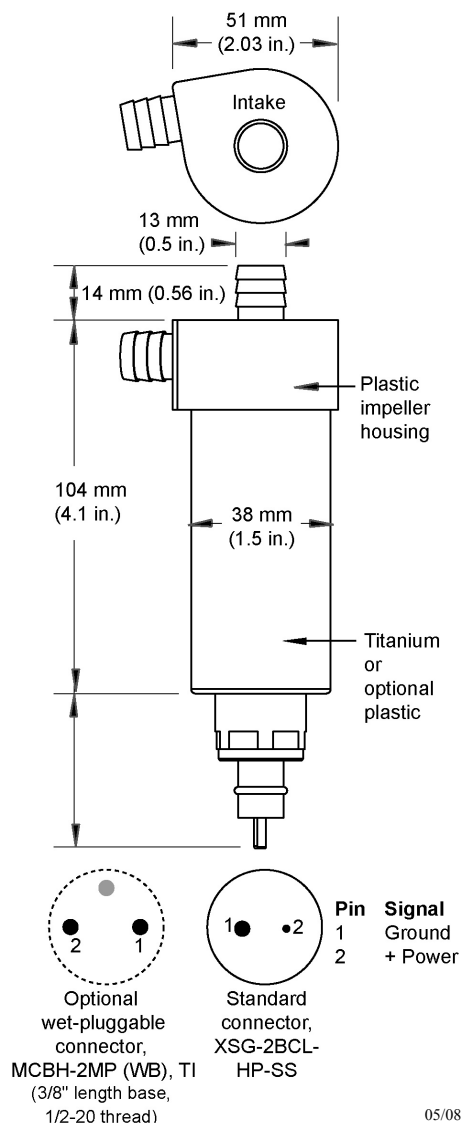
Flow Rate 25 ml/s                      Supply current 95 mA  
*Note: Supply current is independent of operating voltage.*

**Option 5M-2 (pulsed duty):**  
Input voltage range 6 - 18 VDC

Pulse Duration	Flow Volume	Electrical Charge
0.5 seconds	15 ml	0.148 Amp-seconds
1.0 seconds	21 ml	0.283 Amp-seconds
1.5 seconds	31 ml	0.418 Amp-seconds
2.0 seconds	40 ml	0.553 Amp-seconds

## Weight

With standard **titanium** housing:  
In Air - 0.42 kg (0.91 lbs); In Water - 0.28 kg (0.60 lbs)  
With optional **plastic** housing:  
In Air - 0.28 kg (0.60 lbs); In Water - 0.13 kg (0.29 lbs)





Sea-Bird Electronics, Inc.

1808 136th Place NE, Bellevue, Washington 98005 USA  
 Website: <http://www.seabird.com>

FAX: (425) 643-9954

Tel: (425) 643-9866  
 Email: [seabird@seabird.com](mailto:seabird@seabird.com)

## SBE 5M MINI SUBMERSIBLE PUMP CONFIGURATION SHEET

Serial Number: **1058**

Job Number: **50959**

Customer: **NOAA/PMC**

Delivery Date: **10/3/2008**

Single Bulkhead Connector.

Pressure Case: 10,500 meters (titanium)

Maxon Motor Type:

**P/N 801605, Motor PN 20130 (Pulsed Duty 6 VDC, 2000 RPM MAX)**

**P/N 801606, Motor PN 20127 (Continuous Duty 9 VDC, 2000 RPM MAX)**

Vin 15V voltage across C2: **7.95** VDC Current **13.2** mA

Vin 9V voltage across C2: **7.95** VDC Current **13** mA

Vin 6V voltage across C2: **5.87** VDC Current **9.96** mA

Pump submerged test, no load, Vin 12VDC Average current draw in water: **116** mA

# LEICA NA2 · NAK2



*Universal automatic level*

**Leica**  
Geosystems

# LEICA NA2

## The classical level from Leica Geosystems

The NA2 universal automatic level meets all requirements regarding precision, convenience and reliability.

It was designed by surveyors and development engineers with years of experience and who know what a field instrument has to be able to do.

The NA2 soon pays for itself, because it can be used for all types of surveying job; on building sites for routine levelling, in engineering projects, and for geodetic control at all levels of accuracy.

### *Universal application*

- Levelling of all types and all orders of accuracy
- Precise levelling and settlement determinations on buildings
- Routine heighting for the construction of roads, railways, pipelines, tunnels and so forth
- Setting-out work and control measurements on the construction site
- Area levelling of high accuracy
- Tacheometric levelling with the K-version on flat terrain by combining stadia and angular measurements with height readings
- Deformation measurement and monitoring of bridges



# Quickly set up, simple to use

## **Strong tripods**

In principle, the NA2 can be set up on any Leica Geosystems tripod. In practice, for all-round purposes, we recommend the heavy-duty GST20 telescopic-leg tripod. For precise levelling the GST40 fixed-leg tripod is suitable because of its extreme rigidity.

The modular relationship between instrument and tripod is an advantage when transport space is limited.

## **Centring is easy**

The circular level only needs to be centred approximately to bring the compensator well into its working range of  $\sim 30'$ , and so setting-up goes quicker.

The bubble is viewed positively via a pentaprism and is monitored down the eyepiece.

## **Play-free footscrews**

The pitch of the smooth-running and backlash-free footscrews is such that the bubble can be centred in a very short time.

## **Independent of temperature**

Unlike the tubular level of a traditional instrument, the NA2 universal automatic level is relatively insensitive to direct solar radiation and an umbrella need only be considered for the most precise levelling.



# Adjust the line of sight automatically

## Easy to level up

The advantage of this instrument is that, as soon as the bubble is centred, the line of sight is horizontal for all pointings of the telescope. The observer is freed of the time-consuming centring procedure involved with the traditional tubular level, and can concentrate on the business of staff readings.

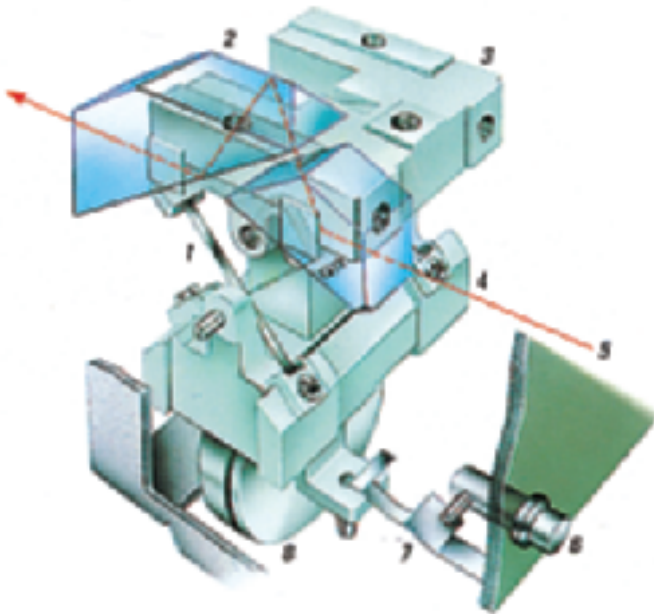
## Robust and automatic

The compensator is essentially a pendulum with a prism (4).

The suspension system comprises four flexed tapes (1) made of a special alloy to ensure faultless functioning even at extreme temperatures. The compensator, which is located between the focusing lens and the crosshair reticle, is pneumatically damped against mechanical vibration and is screened against magnetic fields.

## Minimum maintenance

In the unlikely event that the compensator is damaged (and this can only happen as a result of extremely harsh treatment) it is replaced easily, being held only by three screws.



### 2/NAK2 compensator

- 1 suspension tapes
- 2 prism (fixed)
- 3 compensator body
- 4 pendulum with prism
- 5 line of sight
- 6 push-button
- 7 spring which taps pendulum
- 8 pneumatic damping mechanism

## Push-button control – added security

With most automatics one taps the tripod or instrument to check if the compensator is functioning. Leica Geosystems offers a far more sophisticated solution.

Pressing the button under the NA2 eyepiece gives the compensator a gentle tap, so that you see the staff image swing smoothly

away and then float gently back to give the horizontal line of sight. This check, which takes less than a second, is technically perfect, as the pendulum itself is activated and swings through its full range. It is also immediately apparent if the bubble is not centred.



27  
3  
25  
23

# Top-class optics

## Top-class optics

The telescope is of excellent quality and gives a bright, high-contrast, erect image, even in poor light – an essential for accurate levelling. With the standard eyepiece the magnification is 32x, the optimum for most applications of the instrument. Optional eyepieces are available; the 40x may be preferred for precise levelling, the 25x in hot, shimmer conditions. Eyepiece exchange takes only a second or so.

The focusing knob has a coarse/fine movement:

- coarse, for rapid setting with minimum turning
- fine, for the final delicate touch to give the perfect image.

## At an advantage on unstable ground

If a tubular level is used on unstable ground it tilts out of range and has to be continuously reset. By contrast, the pendulum of the NA2 “compensates” and keeps the line of sight horizontal.

## Fatigue-free viewing

The reticle has:

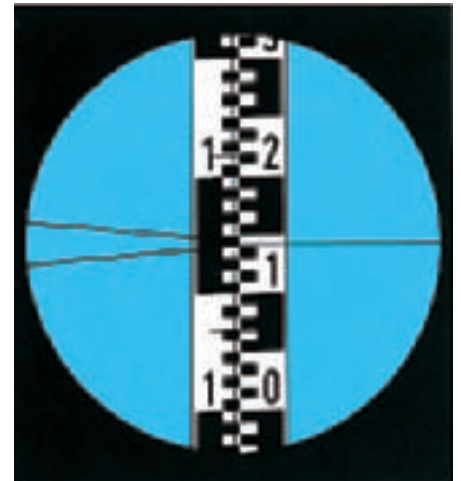
- a single horizontal hair for reading normal staffs
- a wedge-shaped hair for use with invar staffs
- stadia hairs for distance measurement and three-wire levelling.

The general layout of the controls, the smooth friction-braked rotation of the instrument, and the endless horizontal drive with bilateral knobs, all combine to make the instrument easy to use.

## Angle measurement with the NAK2

Civil engineers and contractors often require a circle for angle measurement and setting-out work. Even simple detail surveys, by taking angle, distance and height, and plotting with the polar method, can be done with a level.

The model NAK2 has an internal glass circle which is read via a scale microscope and which can be set to any value by turning the rim around the base of the instrument.



NA2 field of view with metric levelling staff  
Reading at horizontal hair: 1.143 m



NAK2  
circle reading (400 gon)  
392.66 gon



NAK2  
circle reading (360°)  
314°42'

# High-performance accessories for precise levelling

## **GPM3** **parallel-plate micrometer**

This optional accessory slips over the telescope objective and blends perfectly with the smooth lines of the NA2. With a compensator setting accuracy of  $\pm 0.3''$  (equivalent to 0.01 mm in 10 m) and a micrometer reading to 0.1 mm direct and 0.01 mm by estimation, the NA2 with GPM3 is an ideal combination for precise levelling, deformation studies, and even optical tooling. The micrometer drive for raising and lowering the line of sight is conveniently located and readings are taken on a glass scale viewed through an eyepiece just above the telescope eyepiece. This optical reading system, which is digital apart from the last and estimated figure in the metric and inch versions, is superior to the usual metal drum system.

## **GPM6** **parallel-plate micrometer**

There are tasks for which a micrometer is needed, yet for which the very high accuracy of the GPM3 is not essential.

To meet this requirement, a simpler micrometer attachment, the GPM6 with drum reading, is available for the NA2.

The GPM6 fits on to the telescope objective in the same manner as the GPM3, but the graduation is engraved on a metal drum.



## **Eye-piece accessories for specialized tasks**

Because of the bayonet fastening of the interchangeable eyepiece, all theodolite eyepiece accessories can be used with the NA2.



- Diagonal eyepiece for observing from above, below, and from the side; useful in cramped spaces



- Eyepiece lamp for converting the NA2 into a horizontal collimator for laboratory work



- Autocollimation eyepiece for setting machine parts and instrument components precisely vertical



***Compact***

---

The rugged NA2 is indifferent to weather conditions and is extremely reliable in the rough world of the building site. The pendulum compensator is protected against knocks and shocks. There is a highly-effective vibration-damping mechanism.



***Precise***

---

The high setting accuracy ensures that the line of sight stays put. The attachable parallel-plate micrometer renders the NA2 ideal for precise fine levelling.

***Reliable, automatic, maintenance-free***

---

The instantaneous check facility with the push-button control not only makes work easier; it also promotes confidence.



***Easy handling***

---

The convenient, well-arranged controls are designed for maximum convenience. The bilateral, endless horizontal drive promotes rapid fine-pointing.

***Quick levelling-up***

---

The instrument is quickly set up with the three rapid-action footscrews. Their self-adjusting threads make subsequent resetting unnecessary.



***Superb telescope***

---

Telescope with excellently-corrected optics for bright, high-contrast images. All optical components are coated on both sides.

***Effortless focusing***

---

The erect image seen down the telescope is quickly and accurately brought into focus with the convenient rapid and fine focusing knob.

***Abundant accessories; many applications***

---

Additional items such as the parallel-plate micrometer, the laser eyepiece, or the theodolite eyepiece accessories, offer almost unlimited possibilities.



# LEICA NA2·NAK2

## Proven reliability ensures precise results

### Versatile accessories for demonstrable success

A comprehensive program of accessories enables you to expand the performance and applications range of each instrument. This way, you can match your equipment exactly to requirements.

The possibilities are described in brochure "Survey accessories" 710 883en.

### Robust container for safe transport

The NA2 is supplied in a foam-padded container made of high performance synthetic material. The foam padding absorbs all jolts and shocks. The container provides perfect protection for the NA2.

### Technical data

Standard deviation for 1 km double-run levelling, depending on type of staff and on procedure	up to 0.7 mm
With parallel-plate micrometer	0.3 mm
Telescope	erect image
Standard eyepiece	32×
FOK73 eyepiece (optional)	40×
FOK117 (optional)	25×
Clear objective aperture	45 mm
Field of view at 100 m	2.2 m
Shortest focusing distance	1.6 m
Multiplication factor	100
Additive constant	0
Working range of compensator	~30'
Setting accuracy of compensator (stand. dev.)	0.3"
Sensitivity of circular level	8'/2 mm
Glass circle (K version)	400 gon (360°)
Graduation diameter	70 mm
Graduation interval	1 gon (1°)
Reading by estimation to	10 mgon (1')
Water- and dust resistance	IP53
Temperature range:	
Operation	-20°C to +50°C (- 4°F to 122°F)
Storage	-40°C to +70°C (-40°F to 158°F)

Parallel-plate micrometer (optional accessory)	Range	Interval	Estimation
GPM3, with glass scale	10 mm	0.1 mm	0.01 mm
GPM6, with metal drum	10 mm	0.2 mm	0.05 mm



**Total Quality Management –  
Our commitment to total  
customer satisfaction**

Ask your local Leica Geosystems agent for more information about our TQM program.

**Leica**  
Geosystems

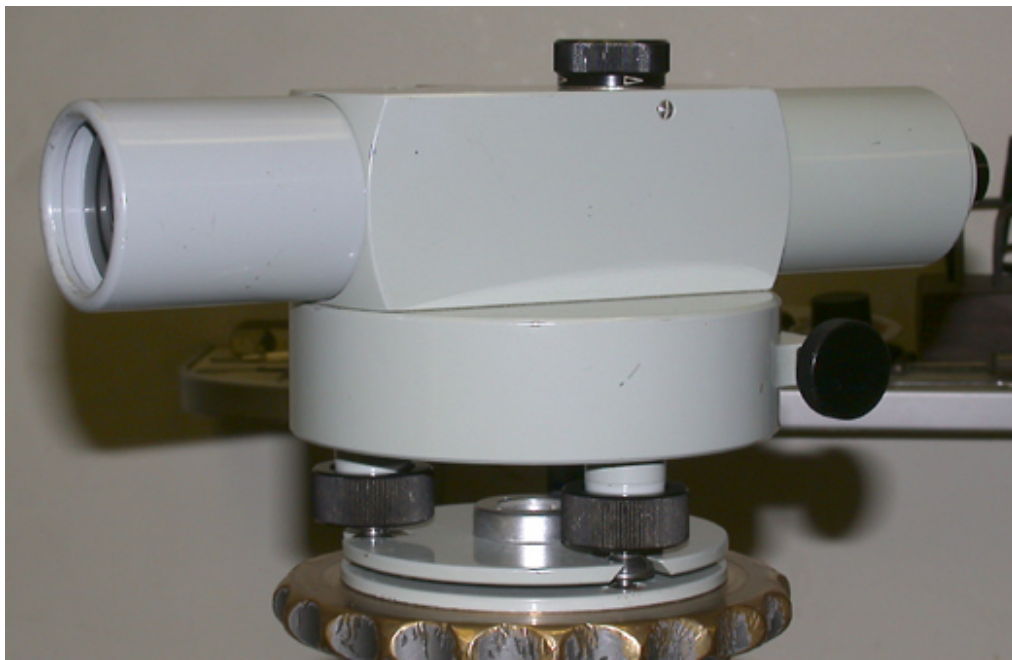
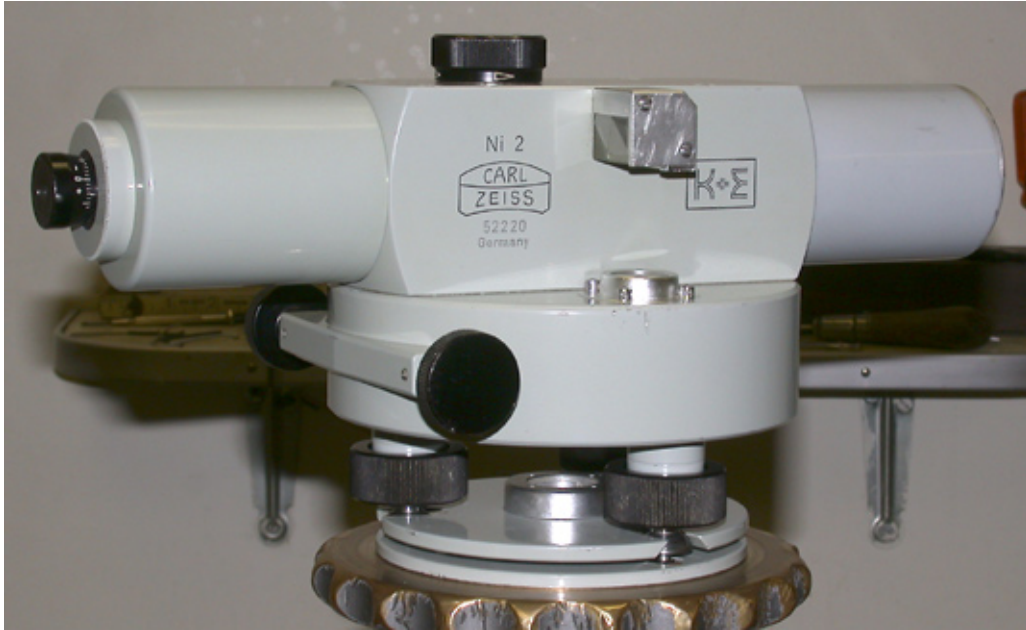
Leica Geosystems AG  
CH-9435 Heerbrugg  
(Switzerland)

Phone +41 71 727 31 31

Fax +41 71 727 46 73

[www.leica-geosystems.com](http://www.leica-geosystems.com)

## Carl Zeiss NI-2 Level



## Contents

No		Page
	Optical Data	2
	Ni 2 Illustration	3
	Mechanical Data	4
01	Setting up, Reading	5
10	<b>Adjustments</b> Circular level to vertical axis	7
20	<b>Line of collimation (horizontal)</b>	7
30	Circular level on staff	9
40	<b>Mechanical adjustments</b> Lateral fine movement	9
42	Leveling screws	9
41	Lateral coarse movement	9
42	Leveling screws	9
43	Tripod joints	10
44	Tripod clamps and tips	10
50	<b>Leveling</b> Contour surveys	10
60	Line leveling	12
70	Precise leveling	13
81	<b>Accessories</b> Parallel plate micrometer	15
84	Short-focus lens	17
91	Torch attachment	19
		1

## Optical Data

### Telescope with Zeiss T-coating

Magnification	32 ×
Aperture	1.58 in (40 mm)
Shortest sighting distance	11 ft (3.3 m)
Field of view	23 ft at 1000 ft

Estimation of  $\frac{1}{1000}$  ft. on  $\frac{1}{100}$  ft. graduation up to 120 ft  
(1 mm on a 1 cm graduation up to 120 m)

### Circular Level

Sensitivity 15 per 2 mm

### Circle (on request)

Material	Glass
Diameter	2.95 in (75 mm)
Graduation	360° or 400 <sup>g</sup>
Graduation interval	1° or 1 <sup>g</sup>

### Readings through reading microscope

Magnification	17 ×
Scale interval	10 or 0.1 <sup>g</sup>
Estimation to	1 or 0.01 <sup>g</sup>

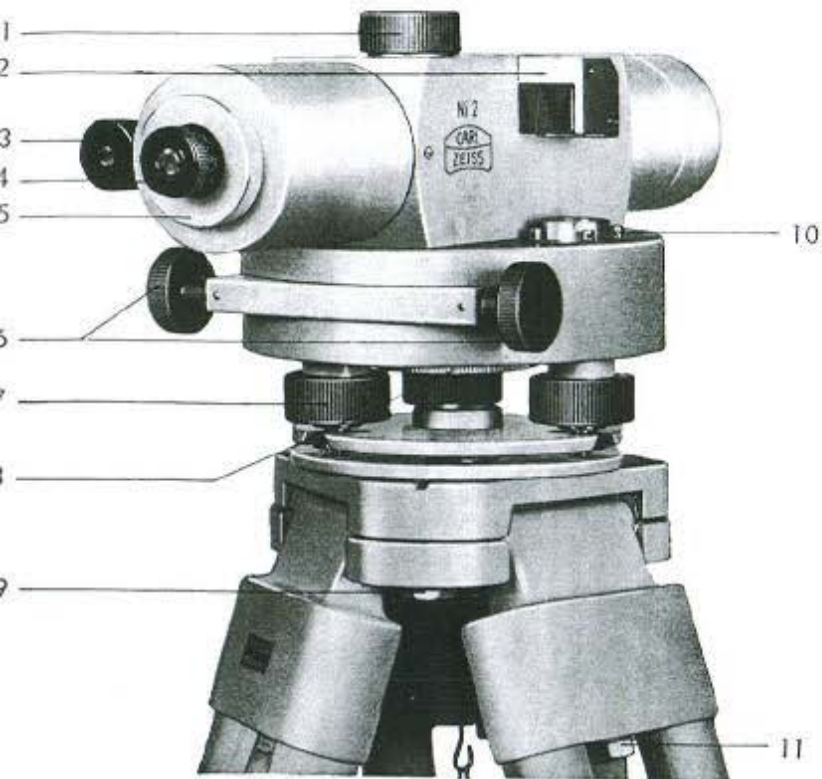


Fig. 1 Ni 2 with horizontal circle  
(about 1/3 natural size)

- |   |   |
|---|---|
| 1 Focus control with quick-fine movement    | 7 Leveling screw                              |
| 2 Viewing prism for circular level          | 8 Knurled setting ring for circle orientation |
| 3 Eyepiece of reading microscope for circle | 9 Adjusting screw for tripod hinges           |
| 4 Telescope eyepiece with dioptré scale     | 10 Adjusting screws for circular level        |
| 5 Screw cover over reticle adjusting screw  | 11 Clamping screw for tripod leg fitting      |
| 6 Lateral fine movement controls            |   |

## Mechanical Data

### Dimensions:

Length of telescope	10.6 in. (27 cm.)
Height of instrument	5.1 in. (13 cm.)
Diameter of base	5.1 in. (13 cm.)
External dimensions of case	13×6.9×6.1 in.

S 3 tripod extending from . . . . . 3 ft. 5 in. to 5 ft. 7 in. (approx.)

S 2 tripod extending from . . . . . 3 ft. 5 in. to 5 ft. 7 in. (approx.) (102–170 cm.)

### Weights:

Ni 2 without circle	4.6 lbs. (2.1 kg.)
Ni 2 with circle	5.3 lbs. (2.4 kg.)
Case for Ni 2 without circle	6.4 lbs. (2.9 kg.)
Case for Ni 2 with circle, with plumb bob	6.6 lbs. (3.0 kg.)
Parallel plate micrometer in leather case	1.3 lbs. (0.6 kg.)
Torch with supports	0.7 lbs. (0.3 kg.)
Leather case for torch	1.7 lbs. (0.7 kg.)
S 3 tripod	11.6 lbs. (5.3 kg.)
S 2 tripod	13.6 lbs. (6.2 kg.)
Leveling staff (03) 4 m. folding to 2 m.	12 lbs. (5.5 kg.)
Leveling staff (05) 3 m. folding to 1.5 m.	6.4 lbs. (2.9 kg.)
Invar staff (06) 3 m., rigid	9 lbs. (4.0 kg.)
"Scotch light" staves, additional weight	0.45 lbs. (0.2 kg.)

- 01 Tripod legs only, not n stiffness of (1 m.) apar tips moder
- 02 Lift instrum secure tigh
- 03 Center circ hairs on a the eyepiec

**Caution:** D over an ex dried with allowed to of the cont

- 04 Aim telesc edge of the
- 05 For fine set the fine mo
- 06 Focus for focus conti matically in
- 07 Read staff necessary slightly tap movement



## Mechanical Data

### Dimensions:

Length of telescope	10.6 in. (27 cm.)
Height of instrument	5.1 in. (13 cm.)
Diameter of base	5.1 in. (13 cm.)
External dimensions of case	13×6.9×6.1 in. (33×17.5×15.6 cm.)
S 3 tripod extending from	3 ft. 5 in. to 5 ft. 7 in. (approx.) (102–170 cm.)
S 2 tripod extending from	3 ft. 5 in. to 5 ft. 7 in. (approx.) (102–170 cm.)

### Weights:

Ni 2 without circle	4.6 lbs. (2.1 kg.)
Ni 2 with circle	5.3 lbs. (2.4 kg.)
Case for Ni 2 without circle	6.4 lbs. (2.9 kg.)
Case for Ni 2 with circle, with plumb bob	6.6 lbs. (3.0 kg.)
Parallel plate micrometer in leather case	1.3 lbs. (0.6 kg.)
Torch with supports	0.7 lbs. (0.3 kg.)
Leather case for torch	1.7 lbs. (0.7 kg.)
S 3 tripod	11.6 lbs. (5.3 kg.)
S 2 tripod	13.6 lbs. (6.2 kg.)
Leveling staff (03) 4 m. folding to 2 m.	12 lbs. (5.5 kg.)
Leveling staff (05) 3 m. folding to 1.5 m.	6.4 lbs. (2.9 kg.)
Invar staff (06) 3 m., rigid	9 lbs. (4.0 kg.)
"Scotch light" staves, additional weight	0.45 lbs. (0.2 kg.)

## Setting up, Reading

- 01 Tripod legs should be extended to a convenient height only, not necessarily to their maximum; observe correct stiffness of joints (see No. 43); spread legs about 3 ft. (1 m.) apart; level tripod head to eyesight; tread tripod tips moderately into ground.
- 02 Lift instrument slightly to find thread for center screw and secure tightly.
- 03 Center circular level with leveling screws. Focus crosshairs on a bright background by turning the milled ring of the eyepiece (4, fig. 1).

**Caution:** Do not store wet instrument in the container over an extended period of time. Instrument should be dried with a cloth on the outside as soon as possible and allowed to get completely dry overnight (to be taken out of the container for that purpose).

- 04 Aim telescope roughly onto target by viewing along one edge of the telescope housing.
- 05 For fine setting observe through telescope and use one of the fine movement screws (6).
- 06 Focus for a parallax-free staff image with dual speed focus control (1). Reversing the sense of rotation automatically introduces a slow motion (range: 1/4 turn).
- 07 Read staff graduation against horizontal crosshairs (if necessary also stadia lines, fig. 2). As a checking measure slightly tap the telescope with a pencil or operate the fine movement screw jerkily to and fro. After a small oscillat-

# Positioning Data Link™

# PDL™

## High Performance Data Link

Designed for Survey Systems

### 19,200 Baud Rate

Higher Over-the-Air Link Rate  
Extends Your Battery Life

### Enhanced User Interface

Change Channels in the Field  
View Status Information

### Compatible with GPS RTK Equipment Worldwide

Complete Kit Solutions Available  
for Your Application

### Reliable

Rugged, All Season Operation

### 2 Year Warranty

Lower Cost of Ownership



Surveyors utilizing Global Positioning Systems require a rugged radio modem data link for precise positioning information. The PDL is compact and lightweight and offers power efficient operation. It is easy to use, and provides high performance and rugged dependability for the toughest survey environments.

PDL Products are designed to easily mount on all standard tripods and range poles. Complete kit solutions are available.



# Positioning Data Link™

	High Power Base	Low Power Base	Rover
<b>General Specifications</b>			
DTE – DCE Interface	3 Wire, RS-232, 38.4k Baud Maximum.		
User Interface	On/Off Button. Channel Button with AutoBase™ and AutoRover™. Digital Display. Modem/Power Status Indicators. RF Power Select Toggle Switch.	On/Off Button. Channel Button with AutoBase™ and AutoRover™. Digital Display. Modem/Power Status Indicators.	On/Off Button. Channel Button with AutoBase™ and AutoRover™. Digital Display. Modem/Power Status Indicators.
<b>Power</b>			
External	9 – 16 VDC.		
Internal Battery <input type="checkbox"/> <input type="checkbox"/>	N/A <input type="checkbox"/> <input type="checkbox"/> <input type="checkbox"/> <input type="checkbox"/> <input type="checkbox"/>	N/A. <input type="checkbox"/> <input type="checkbox"/> <input type="checkbox"/> <input type="checkbox"/> <input type="checkbox"/>	Lithium Ion Battery Pack.
During TX (nominal) <input type="checkbox"/>	110 Watts. <input type="checkbox"/> <input type="checkbox"/> <input type="checkbox"/> <input type="checkbox"/>	11 Watts. <input type="checkbox"/> <input type="checkbox"/> <input type="checkbox"/> <input type="checkbox"/>	N/A.
During RX (nominal) <input type="checkbox"/>	1.9 Watts. <input type="checkbox"/> <input type="checkbox"/> <input type="checkbox"/> <input type="checkbox"/>	0.9 Watts. <input type="checkbox"/> <input type="checkbox"/> <input type="checkbox"/> <input type="checkbox"/>	0.3 Watts.
<b>Antenna</b>			
External <input type="checkbox"/> <input type="checkbox"/> <input type="checkbox"/>	50 Ohm, BNC. <input type="checkbox"/> <input type="checkbox"/> <input type="checkbox"/> <input type="checkbox"/>	50 Ohm, NMO. <input type="checkbox"/> <input type="checkbox"/> <input type="checkbox"/> <input type="checkbox"/>	50 Ohm, NMO.
<b>Modem Specifications</b>			
Link Rate/Modulation	19,200 bps/4 Level FSK. 9600 bps/4 Level FSK. 9600 bps/GMSK. 4800 bps/GMSK.		
Link Protocols	Transparent, Packet Switched, Digipeater, TRIMTALK™.	Transparent, Packet Switched, Digipeater, TRIMTALK™.	Transparent, Packet Switched, TRIMTALK™.
Forward Error Correction	Hamming Code (12, 8) with Data Interleaving.		
<b>Radio Specifications</b>			
Frequency Bands	Refer to price list for available frequency bands.		
Frequency Control	Synthesized 12.5k Hertz Resolution. ±2.5 ppm Stability.		
RF Power Select <input type="checkbox"/> <input type="checkbox"/>	Low/High. <input type="checkbox"/> Factory Programmable. <input type="checkbox"/>	<input type="checkbox"/> N/A.	
RF Transmitter Output <input type="checkbox"/>	3/35 Watts Maximum. <input type="checkbox"/> <input type="checkbox"/> <input type="checkbox"/>	0.5 – 2 Watts. <input type="checkbox"/> <input type="checkbox"/> <input type="checkbox"/> <input type="checkbox"/>	0 Watt (Receive Only).
Sensitivity	-116 dBm (12 dB SINAD).		
Adjacent Channel Selectivity	>-60 dB.	>-70 dB at 9600 bps/GMSK. >-60 dB at 19,000 bps/4 Level FSK.	>-60 dB.
Type Certification	All models are type accepted and certified for operation in the U.S. and Canada. For detailed information concerning your country's type certification, please contact your sales representative.		
<b>Environmental Specifications</b>			
Operating Temperature	-22 ° to +140 ° F (-30 ° to +60 ° C).		-4 ° to +140 ° F (-20 ° to +85 ° C).
Storage Temperature	-67 ° to +185 ° F (-55 ° to +85 ° C).		-4 ° to +185 ° F (-20 ° to +85 ° C).
Vibration/Shock	ANSI/ASAE EP455.		
Enclosure	IEC 60529 I.P. 66. Water Tight and Dust Proof.		
<b>Mechanical Specifications</b>			
Dimensions	6.23" W x 2.77" H x 6.58" L (15.8 cm W x 7.0 cm H x 16.7 cm L).	8.25" L x 2.40" Diameter. (21.0 cm L x 6.1 cm Diameter).	8.25" L x 2.40" Diameter. (21.0 cm L x 6.1 cm Diameter).
Weight <input type="checkbox"/> <input type="checkbox"/> <input type="checkbox"/>	2.96 lbs. (1.34 Kg). <input type="checkbox"/> <input type="checkbox"/> <input type="checkbox"/>	0.65 lbs. (0.30 Kg). <input type="checkbox"/> <input type="checkbox"/> <input type="checkbox"/>	0.75 lbs. (0.34 Kg).
Data/Power Connector <input type="checkbox"/>	5 Pin LEMO #1 Shell. <input type="checkbox"/> <input type="checkbox"/> <input type="checkbox"/>	5 Pin LEMO #0 Shell. <input type="checkbox"/> <input type="checkbox"/> <input type="checkbox"/>	5 Pin LEMO #0 Shell.
Mount <input type="checkbox"/> <input type="checkbox"/> <input type="checkbox"/>	Tripod Bracket. <input type="checkbox"/> <input type="checkbox"/> <input type="checkbox"/>	5/8" – 11 Range Pole. <input type="checkbox"/> <input type="checkbox"/> <input type="checkbox"/>	5/8" – 11 Range Pole.



**PACIFIC CREST**  
CORPORATION

990 Richard Avenue, Suite 110, Santa Clara, CA 95050  
1-800-795-1001, Tel: 408-653-2070, Fax: 408-748-9984  
Web: www.paccrst.com, E-mail: sales@paccrst.com

©2000 Pacific Crest Corporation.  
License required prior to operation of radio communication equipment. Specifications subject to change without prior notice.  
TRIMTALK™ is a trademark of Trimble Navigation Limited.

M00526-9/02





## INSTANT-RTK TECHNOLOGY

# Z-Xtreme Survey System

### Z-Xtreme

The Ashtech® Z-Xtreme™ from Thales Navigation professional products is a rugged, weather-proof, dual-frequency GPS receiver designed to provide surveyors with cost-effective, centimeter-accurate positions in a variety of system configurations.

The Z-Xtreme receiver begins with state-of-the-art satellite electronics coupled with patented Z-Tracking™ to deliver the highest GPS signal reception level. A removable battery and flash memory card provide enough capacity to last all day for maximum utility. Components are completely integrated inside a weather-proof, high impact plastic housing, ensuring your investment is safe, rain or shine. Use the easy-to-operate interface on the front panel for important functions such as site information entry, survey status, and set-up of RTK base stations without the additional cost of a handheld controller. The result: Z-Xtreme with Instant-RTK® outperforms all other receivers in its class!

### ZX-SOLUTIONS

The Z-Xtreme survey system from Thales Navigation provides a range of solutions designed for the vast array of positioning needs – from entry level static or kinematic post-processed surveys, all the way up to real-time functions such as stake out. The entry level ZX-Solutions™ system dramatically increases your productivity for control surveys and other post-processed applications. Add an optional kinematic kit to make topographic feature collection more cost effective. Use Ashtech Solutions™ software to easily process the field data, export results and



generate reports. Purchase only what you need for the job at hand because ZX-Solutions is fully upgradeable.

### ZX-SUPERSTATION

Eclipse the productivity of optical instrument stake out with a ZX-SuperStation™. The ZX-SuperStation is a field-to-finish GPS surveying system that combines the Z-Xtreme receiver with a powerful data collector and wireless modems for centimeter accuracy in real-time. Instant-RTK gives you the ability to initialize the centimeter solution in a fraction of the time of conventional RTK systems. Powerful data collection software gives you the ability to efficiently perform GPS surveying techniques and to interface seamlessly with optical total stations.

**Ashtech Technology**

- 12 channel all-in-view operation
- Full-wavelength carrier on L1 and L2
- Z-Tracking
- Multipath mitigation
- Dual-frequency smoothing for improved code differential
- Instant-RTK

**Performance Figures<sup>1</sup>****Static, Rapid Static**

- Horizontal: 0.005 m + 1 ppm  
(0.016ft+1ppm)
- Vertical: 0.010 m + 1 ppm  
(0.033ft + 1ppm)

**Post-Processed Kinematic**

- Horizontal: 0.010 m + 1 ppm  
(0.033ft + 1ppm)
- Vertical: 0.020 m + 1 ppm  
(0.065ft+1ppm)

**Real-Time Code Differential Position**

- <1 m (3.28 ft)

**Real-Time Z Kinematic Position (Fine Mode)**

- Horizontal: 0.010 m + 2 ppm  
(0.033ft + 2 ppm)
- Vertical: 0.020 m + 2 ppm  
(0.065ft + 2 ppm)
- Azimuth (arc sec): 0.4 + 2.0/baseline (km)

**RTK Occupation Time**

- 2 seconds (typical - sub-centimeter accuracy with longer occupation time)

**Instant-RTK Initialization**

- 99.9% reliability
- Typically <2 seconds with 6 or more satellites, PDOP <5, baseline length <7 km (4.35 mi), open sky and low multipath conditions

**RTK Operating Range**

- Recommended: 10 km (6.21 mi)
- Maximum: 40 km (24.85 mi)

**Standard Features**

- 16 MB PCMCIA removable memory card
- NMEA 0183 output
- Selectable update rate from 999 sec to 10 Hz
- Event marker
- Point positioning
- 1 PPS timing signal
- Session programming

- Wide array of coordinate transformations
- Removable internal battery
- 8-character alphanumeric LED display with 4-button interface
- 3 function LED display - Radio, Memory, Satellites/Power
- Multi-function audible alarm
- Quick reference card holder
- External mount capabilities
- External power input
- 4 RS-232 ports (115200 baud max, 3 external, 1 internal)
- 1-year warranty
- Free factory technical support

**Standard Accessories**

- Communications software
- Padded system bag and hard case
- RS-232 data cable
- Receiver operating manual
- Quick reference field card

**Technical Data****Environmental**

- Z-Xtreme Receiver
- Meets MIL-STD 810E for wind driven rain and dust
- Operating temperature: -30° to +55°C  
(-22° to 131°F)
- Storage temperature: -40° to +85°C  
(-40° to 185°F)

**Geodetic 4 Antenna**

- Meets IPX7 specifications for submersion
- Operating temperature: -55 to +75°C  
(-40° to 149°F)
- Storage temperature: -55° to +75°C  
(-67° to 167°F)

**Physical**

- Weight
- Receiver: 1.59 kg (3.50 lb)
- Antenna: 0.82 kg (1.81 lb)
- Battery: 0.43 kg (0.95 lb)
- Dimensions
- 76.2 H x 196.85 W x 222.25 D mm
- (0.25 H x 0.646 W x 0.729 D ft)
- Power
- 10 - 28 VDC, 6.0 W

**Internal battery**

- Capacity: 6000 mAh
- >9 hours (typical) @ 25°C (77°F)
- Operating temperature: -30° to +55°C  
(-22° to 131°F)
- Storage temperature: -40 to +60°C  
(-40° to + 140°F)

**PC card**

- ATA Type II PCMCIA memory card (16 MB standard)
- Temperature range: -40° to +85°C  
(-40° to 185°F)
- Data capacity: 4500 epochs per 2 MB\*  
\* Based on one session, eight satellites' data and full measurements. This number can vary significantly depending on the conditions of the session.

**Optional Features**

- Real-time kinematic (base and rover modes) for cm-accuracy
- RTCM 2.2 (Types 1, 2, 3, 9, 16, 18, 19, 20, 21, 22)
- Internal UHF or spread spectrum radio for RTK rover operations
- External UHF or spread spectrum radio for RTK base and rover operations
- Geodetic 4 antenna ground plane kit
- Kinematic antenna kit
- Aircraft antenna kit
- AC power cable
- Choke ring antenna
- Long haul backpack kit
- All-on-a-pole kit

**Optional Application Software****GPS data processing**

- Ashtech Solutions

**Land Surveying and Construction**

- TDS Survey Pro
- Carlson SurvCE
- Ashtech Survey Control II
- Ashtech GPS Fieldmate

**Mining and Land Seismic**

- Ashtech Mine Surveyor II
- Ashtech Seismark II

**Thales Navigation, Inc.****Corporate Headquarters, Santa Clara, CA, USA**

+1 408 615 5100 \* Fax +1 408 615 5200

**Toll Free (Sales in USA/Canada)** 1 800 922 2401

**Email** professionalsales@thalesnavigation.com

**In Washington, DC** +1 703 476 2212 \* Fax +1 703 476 2214

**In South America** +56 2 234 56 43 \* Fax +56 2 234 56 47

**In China** +86 10 6566 9866 \* Fax +86 10 6566 0246

**European Headquarters, Carquefou, France**

+33 2 28 09 38 00 \* Fax +33 2 28 09 39 39

**Email** professionalsalesemea@thalesnavigation.com

**In Germany** +49 81 6564 7930 \* Fax +49 81 6564 7950

**In Russia** +7 095 956 5400 \* Fax +7 095 956 5360

**In UK** +44 (0) 870 601 0000 \* Fax +44 (0) 208 391 1672

**In the Netherlands** +31 78 61 57 988 \* Fax +31 78 61 52 027

**Web site** www.thalesnavigation.com

Thales Navigation follows a policy of continuous product improvement; specifications and descriptions are thus subject to change without notice. Please contact Thales Navigation for the latest product information.

<sup>1</sup> Specifications assume operation follows all the procedures recommended in the product manual utilizing Instant-RTK, post processing with Ashtech Solutions or Ashtech Office Suite for Survey. High-multipath areas, high PDOP values, low satellite visibility, and periods of adverse atmospheric conditions and/or other adverse circumstances will degrade system performance. All accuracy specifications are RMS values.

Nikon

# TOP GUN<sup>®</sup>

## DTM-310

ELECTRONIC TOTAL STATION



# Valuable functions, superior cost-performance, longer battery life and enhanced software



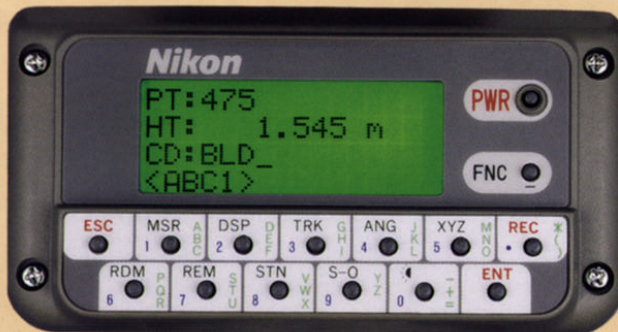
Nikon has just taken the world-renowned Top Gun® DTM-300 total station to a whole new level. The new Top Gun® DTM-310's enhanced keyboard and on-board software enable easy code input in both alphabet and numbers, the way you've always wanted. It builds on existing features — such as the large four-line LCD and full numeric key pad — to improve overall convenience. And software upgrades make it easier to search and display data. In fact, the Top Gun® DTM-310 provides customers in any field — from civil construction to cadastral surveying and mapping — with greater ease of operation.

## ENHANCED BASIC FUNCTIONS

- Large four-line display with full alphanumeric input on both faces
- Meets basic requirements for distance and angle measurement
- Resume function for quick startup and power management
- Enhanced, powerful built-in programs
- 500-point on-board data storage function
- 7.3 hours continuous measuring with one on-board battery
- Compact and lightweight
- Quick access to the 20 most recently stored codes

## CONVENIENT ALPHANUMERIC INPUT

The inclusion of alphabetic input enables you to store codes in a combination of letters and numerals. Codes, target heights (HT) and point numbers are easily input for each new measurement. And codes can also be selected from the most recent 20 codes stored in the memory, eliminating the need to repeatedly input the same codes.



### KEY DESCRIPTIONS

- MSR:** Distance measurement in normal measurement mode
- DSP:** Selects display item by scrolling display
- TRK:** Distance measurement in high-speed measurement mode
- ANG:** Horizontal angle zero-set, user-defined angle input or hold
- XYZ:** Coordinate measurement
- RDM:** Remote distance measurement (continuous or radial)
- REM:** Remote elevation measurement
- STN:** Station setup (known point, 2-point resection or 3-point resection)
- S-O:** Stakeout by inputting angle distance or coordinates
- Illumination:** Display illumination
- REC:** Data record to internal memory
- ENT:** Data entry or sending observation data to communication port in normal observation mode
- FNC:** Input of temperature and barometric pressure, prism constant, and height of target; simple COGO calculation; settings; view/edit stored data; communication (internal memory); vertical collimation correction



# ENHANCED, POWERFUL BUILT-IN PROGRAMS

## On-board data storage function

The DTM-310 memory stores up to 500 raw or coordinate records. Coordinate data can be manually input, measured or

```
PT:476
HT: 1.545 m
CD:CP4_
<123>
```

uploaded from a PC. (Contact your Nikon distributor for download/upload and format conversion software.) Data can be instantly recalled and reviewed for station setup, stakeout and COGO.

## Station setup

For station setups, in addition to the known station setup obtained by inputting the coordinate of backsight or direction angles, a more simplified default station setup is also possible. This can be obtained by setting the station point coordinates at zero

```
Station Setup
1:Known 3:3-P
2:2-P 4:Def.
STN BAT■■■■
```

while maintaining the prior orientation intact. Two- and three-point resections are also available. In the case of a three-point resection, it is possible to transfer the elevation from a bench mark.

## XYZ coordinate measurement

The coordinate system can be set to survey, mathematical or NEZ with independent coordinate order settings. Azimuth

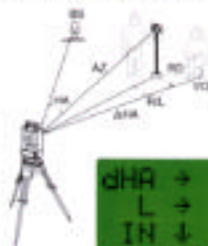
```
N: 1200.169 m
E: 1829.964 m
Z: 29.909 m
XYZ BAT■■■■
```

zero-direction can be set to either north or south. Coordinate calculations are

based on these settings. Point name, number, code and coordinate data can be stored in the data file. The target height can be changed at any time by pressing the FNC key.

## Stakeout

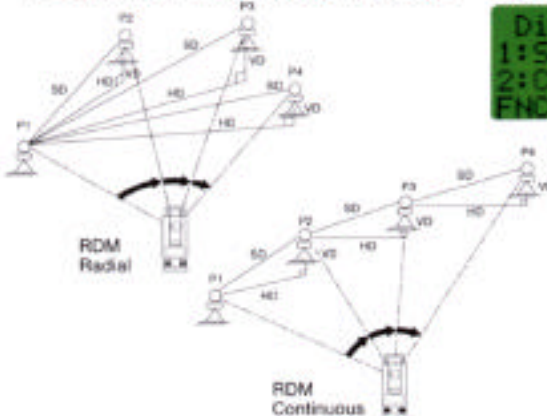
Lets you perform stakeouts by inputting angle and distances, or coordinates. Co-



ordinates can be searched and retrieved from the built-in memory. Zero-direction countdown and delta displays (Left/Right, In/Out, Cut/Fill) make for fast and simple stakeouts. Stakeout data can be also recorded in the internal memory.

## RDM

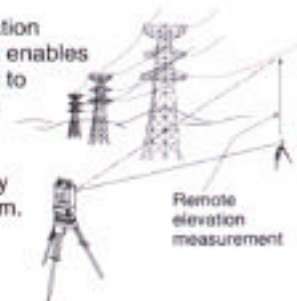
For continuous or radial remote distance measurement. Press the DSP key to se-



lect slope distance, elevation difference, horizontal distance, grade, legal grade ratio between two points, or azimuth from first to second points.

## REM

Remote elevation measurement enables measurement to points (e.g., a power pole) where you cannot directly place the prism.



## COGO calculation

Enables point-to-point inverse calculations, plus azimuth and distance calculations. Coordinates can be searched and retrieved from the on-board memory, and calculated coordinates can be saved.

## Data display

The DTM-310 enables you to search data by tracing back from the most recent record, from specific station points, or from a simple point number.

```
Disp.
1:Station 3>Last
2:Coord.
FNC BAT■■■■
```

## 7.3 HOURS CONTINUOUS OPERATING TIME

Internal battery BC-60 provides about 7.3 hours (with full charge, at 20°C, for distance/angle measurements) of continuous operation. The remaining battery power is indicated by the LCD. As Ni-MH battery BC-60 contains no harmful substance, recycling is not necessary. Quick recharge can be performed in about 2 hours with standard battery charger Q-70U/Q-70E. The Q-70U/Q-70E's discharging function preserves the batteries' minimum power and protects against deterioration.

## RESUME FUNCTION

This resume function can automatically revert to the orientation prior to power OFF, or automatically display the previous horizontal angle. It guarantees the safety of all previous data settings.

## BASIC MEASUREMENT FUNCTIONS

- Built-in Automatic Vertical Compensation
- Vertical Angle Zero-Degree Set Handled in Three Modes
- Grade Display
- With Triple Prism, to 1.2km or 3,900 feet (under good conditions)
- $\pm(5 + 3\text{ppm} \times D)\text{mm}$  Precision
- Automatic Environmental Compensation
- Selectable Angle Reading of 5/10°, 0.5/1mgon, 0.02/0.05MIL
- Angle Measurement Accuracy of 5"/1.6mgon/0.02MIL (standard deviation based on DIN18723)

## Standard Package

- DTM-310 main unit
- On-board battery BC-60
- Battery charger Q-70U/Q-70E
- Lens cap
- Plumb bob
- Tool set
- Plastic case
- Vinyl cover
- Instruction manual

## Optional Accessories

- Diagonal eyepiece prism
- High-power (32x) and low-power (16x) eyepiece lenses
- Compass (tubular type) and compass adapter
- Zenith prism
- Solar filter
- Solar reticle
- External battery B4



On-board battery BC-60 and battery charger Q-70U/Q-70E

## Specifications

<b>Telescope</b>	
Tube length	150mm/5.9 in.
Effective diameter of objective	36mm/1.41 in. (EDM aperture 40mm/1.57 in.)
Magnification	26x (standard)
Field of view	1°30'
Resolving power	3.5"
Minimum focusing distance	1.0m/3.3 ft.
<b>Angle measurement</b>	
Reading system	Incremental encoder
Unit of reading	Degree/Gon/6400MIL
Least count (selectable)	
(360°)	5° or 10°
(400G)	0.5mgon or 1mgon
(6400MIL)	0.02MIL or 0.05MIL
Accuracy (Standard deviation based on DIN 18723)	5"/1.6mgon/0.02MIL
Tilt sensor (Automatic Vertical Compensator)	Liquid type
Working range	±3'
<b>Distance measurement</b>	
Range (with Nikon prism)	
(Normal conditions: ordinary haze, visibility 20km/12.5 miles)	
with mini prism	380m/1,300 ft.
with single prism	800m/2,600 ft.
with triple prism	1,100m/3,700 ft.
(Good conditions: no haze, visibility 40km/25 miles)	
with mini prism	450m/1,500 ft.
with single prism	1,000m/3,300 ft.
with triple prism	1,200m/3,900 ft.
Accuracy	±(5 + 3ppm x D)mm, -10°C to +40°C/+14°F to +104°F
	±(5 + 5ppm x D)mm, -20°C to +50°C/-4°F to +122°F
Maximum measurement display	1,230m/4,000 ft.
Least count	
Standard MSR mode	1mm/0.005 ft.
Tracking mode	10mm/0.05 ft.

<b>Measuring intervals</b>	
Standard MSR mode	4 sec.
Tracking mode	1.2 sec.
Measuring mode	Continuous/Single/Average (2 - 99)
Ambient temperature range	-20°C to +50°C (-4°F to +122°F)
<b>Atmospheric correction range</b>	
Temperature range	-40°C to +60°C (-40°F to +140°F)
Pressure range	400 to 999mmHg (1mmHg step) 15.8 to 39.3 in.Hg (0.1 in.Hg step) 533 to 1,332hPa (1hPa step)
<b>Display</b>	
	Dot-matrix LCD 16 characters x 4 lines
<b>Level vial</b>	
Sensitivity of plate level vial	30"/2mm
Sensitivity of circular level vial	10"/2mm
<b>Leveling base</b>	
Tribrach	Detachable
<b>Optical plummet</b>	
Image	Erect
Magnification	3x
Field of view	5°
Focusing range	0.5m/1.6 ft. to ∞
<b>Power sources</b>	
Type	Ni-MH 7.2V DC
Continuous operating time	7.3 hrs. or 8,760 measurements (for distance/angle measurement) 22 hrs. (for angle measurement only)
<b>Quick battery charger (Q-70U/Q-70E)</b>	
Input voltage	115V for Q-70U, 220/240V for Q-70E
Recharging time	1.5 hrs.
<b>Dimensions (W x D x H)</b>	
Main unit (with carrying handle)	164 x 177 x 335mm/6.5 x 7.0 x 13.2 in.
<b>Weight</b>	
Main unit w/battery	5.5kg/12.1 lbs.
Battery BC-60	0.5kg/1.1 lbs.
Carrying case	2.5kg/5.5 lbs.

These products (DTM-310 and battery charger Q-70U/E) are strategic products subject to Japanese/International export control regime. They should not be exported without authorization from the appropriate governmental authorities.

Specifications and equipment are subject to change without any notice or obligation on the part of the manufacturer. February 1997

©1997 NIKON CORPORATION

East Coast:

**NIKON INC.**

**Instrument Group, Surveying Dept.**

1300 Walt Whitman Road, Melville, NY 11747-3064

Phone: (516) 547-4200 Telefax: (516) 547-8669

West Coast:

**NIKON INC.**

**Instrument Group, Surveying Dept.**

19601 Hamilton Avenue, Torrance, CA 90502

Phone: (310) 516-7124 Telefax: (310) 719-9772

Nikon on the Net <http://www.nikonusa.com/>



Nikon is an official sponsor of FIG.

ISO 9001 Certified



Certificate No. 20242

NIKON CORPORATION  
Instruments Division  
Yokohama Plant

E

# V. SPECIFICATIONS

## 1. Main Unit

### ● Telescope

Image	: Erect/unreversed
Magnification	: 26×
Effective diameter of objective	: 36mm
Field of view	: 1°30'
Minimum focusing distance	: 1.0m
Resolving power	: 3.5"

### ● Distance Measurement

Distance range of Nikon prisms:	450m with mini prism 1000m with single prism 1200m or longer with triple prism *With visibility 40km (25miles)
Precision	: $\pm(5\text{mm} + 3\text{ppm} \times D)$ *With accurate measurement mode, at $-10^{\circ}\text{C} \sim +40^{\circ}\text{C} / +14^{\circ}\text{F} \sim +104^{\circ}\text{F}$ D is measuring distance, mm unit $\pm(5\text{mm} + 5\text{ppm} \times D)$ at $-20^{\circ}\text{C} \leq t < -10^{\circ}\text{C} /$ $-4^{\circ}\text{F} \leq t < +14^{\circ}\text{F}$ and $+40^{\circ}\text{C} < t \leq 50^{\circ}\text{C} /$ $+104^{\circ}\text{F} < t \leq +122^{\circ}\text{F}$
Measuring time response	: [MSR] mode: About 4sec. (initial: about 5sec.) [TRK] mode (cm): About 1.2sec (initial: about 2.2sec.)
Least count	: 1mm
Display	: Up to 1230m
Display unit	: m/ft-INT/ft-US

### ● Angle Measurement

Accuracy	: 5" (Standard deviation based on DIN 18723)
Reading system	: Photoelectric detection by incremental encoder single-sided reading
Display unit	: Degree/Gon/MIL

## V. SPECIFICATIONS

---

### ● Automatic Vertical Compensator

System : Liquid-electric detection  
Working range :  $\pm 3'$

### ● Optical plummet

Image : Erect  
Magnification :  $3\times$   
Field of view :  $5^\circ$   
Focusing range :  $0.5\text{m}\sim\infty$

● Clamps/tangent screws : Coaxial dual speed tangents

### ● Sensitivity of level vials

Plate level vial :  $30''/2\text{mm}$   
Circular level vial :  $10''/2\text{mm}$

● Tribrach : Detachable

### ● Dimensions and weight

Main body : 5.5kg (12lbs) including BC-6 battery pack  
Case : About 3.5kg (7.6lbs)

### ● Operating temperature range:

$-20^\circ\text{C}\sim 50^\circ\text{C}/-4^\circ\text{F}\sim +122^\circ\text{F}$



**SOKKIA**

**SET5F**

Version 01-00  
TOTAL STATION

**Enhanced software with 3,000-point data memory.**



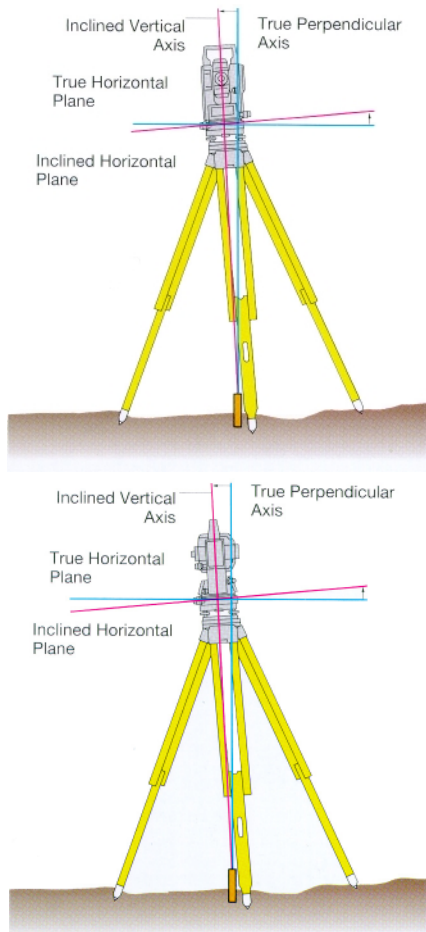
# Flexible, Friendly and Featherweight

The SET5F's powerful EDM, dependable dual-axis compensator and 3,000-point data memory are conveniently packaged in a compact, lightweight body. Software [Version 01-00] has been enhanced for more effective survey work, and "softkey" assignments can be freely customized to suit all user needs.

## Dependable Hardware

### Proven Dual-axis Compensator

- Since its introduction with the Series C total station in 1989, Sokkia's dual-axis compensator has proven its reliability and accuracy at survey sites all over the world.
- The dual-axis tilt sensor monitors deviations of both the X and Y axes and the correct horizontal and vertical angle readings are automatically computed and applied. The result is easier and faster instrument leveling.



### The High-performing EDM

- 1,500m/4,900ft range with a single prism under good ambient conditions (40km/25miles visibility, with no haze, overcast, no scintillation).
- Outstanding precision;  $\pm(3+2\text{ppm}\times D)\text{mm}$ . This corresponds to a

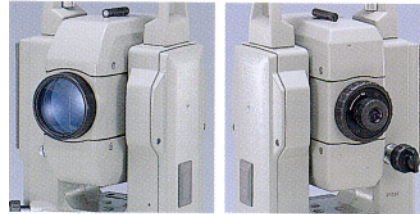
deviation of a mere  $\pm 3.2\text{mm}$  at a distance of 100m and  $\pm 5\text{mm}$  at 1,000m.

- Supreme speed; only 1.7 seconds initial measuring time in the rapid measurement mode.

	Average Conditions	Good Conditions
CP01 Compact Prism	700 m/2,300 ft.	
One AP01 Prism	1,200 m/3,900 ft.	1,500 m 4,900 ft.
Three AP01 Prisms	1,600 m/5,200 ft.	2,000 m 6,500 ft.

### Powerful Telescope

- Highest magnification in its class: 30x
- Easy, accurate sighting of prisms or targets



### Outstanding Mobility

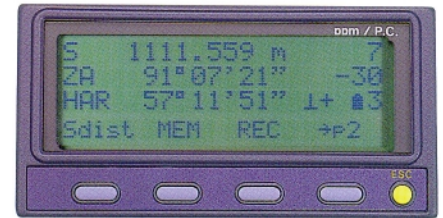
- Total carrying weight (including instrument, tribrach, battery and hard case) is a mere 8 kg/18 lbs. The secret lies in the lightest and most compact carrying case of its kind (W390 x D255 x H220mm / W15.3 x D10.0 x H8.6in.), making the SET5F supremely portable.
- A convenient shoulder strap is provided as standard. An optional back pack (SC94) is ideal for longer day treks.



## Enhanced Software

The SET5F can be easily customized to your preferred key assignments.

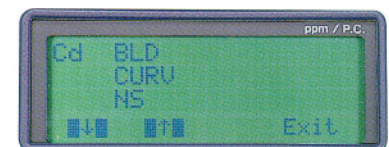
- The SET5F offers optimum keyboard flexibility. Any keyboard layout can be configured. For example, functions can be assigned to any key position on any page, and unused functions can be temporarily deleted.
- A powerful "softkey" feature facilitates input of coordinate values, feature codes, etc.



Key assignment mode

### Spacious 3,000-point Internal Memory

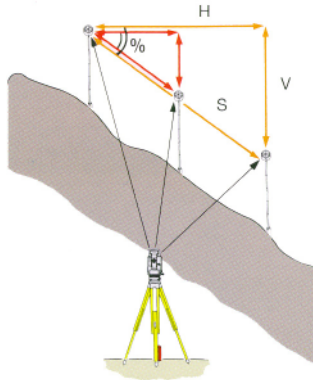
- The SET5F's internal memory is large—holding a full 3,000 data points—and secure. For optimum convenience, measurements can be performed and recorded at the touch of a key.
- Up to five (5) job files can be created to efficiently organize multiple survey tasks.
- Forty (40) feature codes (max.13 characters each) can be kept in the memory for easy recall as needed.



### Sophisticated Application Software Missing Line Measurement (MLM)

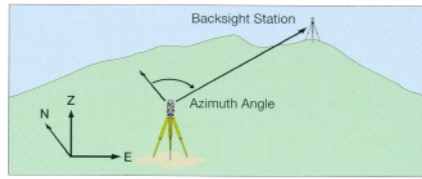
- The SET5F measures horizontal distance, slope distance, height difference, and slope in percent (%) between two prisms, all at the touch of a key.

# The SET5F brings full freedom to survey work.



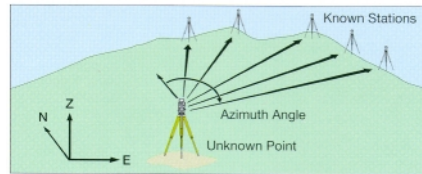
## Azimuth Angle Setting

•Using the coordinates of the instrument station and a back-sight point, the SET5F can automatically set the horizontal angle to the azimuth of the back-sight.



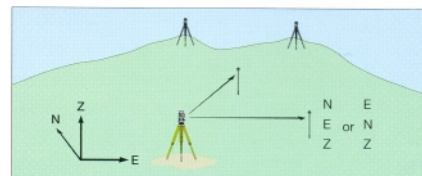
## Resection

•With 2 to 5 known points, the SET5F can be used to determine the azimuth and coordinates of the unknown instrument station.  
•When using 2 known points, both angles and distances are measured. When using 3 or more points, the distance does not always have to be measured.



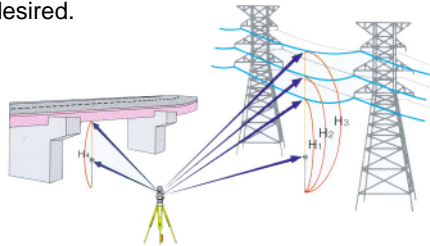
## 3-D Coordinate Measurement

•The SET5F calculates 3-D coordinate values of measuring points.  
•The operator may choose display settings either of "N, E, Z" or "E, N, Z."



## Remote Elevation Measurement (REM)

•The SET5F can be used to easily determine the height of a point where a prism cannot be placed. The system sights a prism directly above or below the target point, and then sights the point desired.

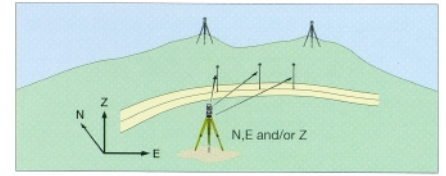


## Angle Repetition

•For enhanced accuracy in the horizontal angle measurement, the SET5F can measure in repetition. It then calculates and displays the average of the multiple angle measurements.

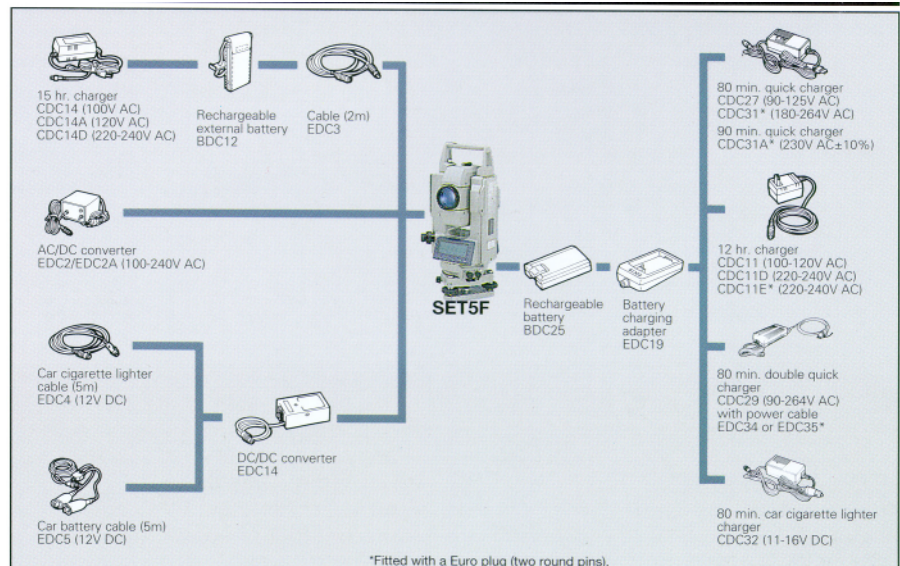
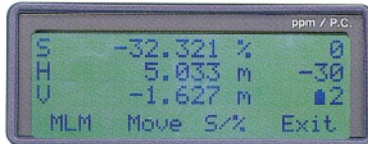
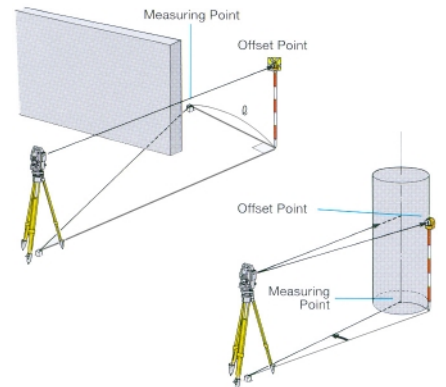
## 3-D Setting-out

•The SET5F can be used to perform 3-dimensional setting-out with N, E and/or Z coordinates.



## Offset Measurements

Two basic offset measurement methods are provided to measure the hidden points. One calls for input of the offset distance and the direction between the measuring point and the prism. The other uses a prism set on the left or right side of the measuring point at the same distance from the SET5F; the angles and distance to the prism are measured, and the measuring point is sighted. In both cases, the SET5F calculates the horizontal and vertical angles and distance, or the N, E, Z coordinates.



\*Fitted with a Euro plug (two round pins).

## Standard Configuration

The SET5F comes with two (2) BDC25 rechargeable batteries EDC19 battery charging adapter CDC27, CDC31 or CDC31A quick charger, CP7 tubular compass, sunshade, lens cap, plumb bob, vinyl cover, tool kit, operator's manual, carrying case and shoulder strap.

## Electronic Field Books (SDR33/SDR31)

Thanks to its advanced two-way communications port, the SET5F's functions can all be accessed by external controller. For example, by connecting one of the Sokkia's acclaimed Electronic Field Books (SDR33 or SDR31), complex field operations such as traverse adjustment, intersection, area calculations and roading can be carried out with remarkable ease.



## Optional Accessories

DE17A	Diagonal Eyepiece
OF1/OF1A	Solar Filters
SC94	Back Pack

## SET5F Specifications

Telescope		Fully transiting, coaxial EDM
Length		165mm (6.5in)
Objective aperture		45mm (1.8in)
Magnification, image		30x, Erect
Resolving power		3.0"
Field of view		1°30'(26m/1,000m)
Minimum focus		1.3m (4.3ft.)
Reticle illumination		Bright or Dim, selectable
Angle measurement		Incremental encoder, diametrical detection
Display resolution	H&V	1"/0.2 mgon/ 0.005 mil, 5"/1 mgon/ 0.02 mil
Angle unit	H&V	Degree/Gon/Mil
Accuracy	H&V	5" (1.5 mgon/ 0.02 mil) according to DIN18723
Dual-axis compensator		Liquid dual-axis tilt sensor, range: ±3' (±55 mgon)
Display mode	H V	Clockwise/ Counterclockwise, Repetition, Oset, Hold available Zenith 0°/ Horizontal 0°/ Horizontal 0°±90°/ Slope%
Distance measurement		Electro-optical with modulated infrared LED.
Measuring range (slope distance)		A: Average conditions; slight haze, visibility about 20km (12 miles), sunny periods, weak scintillation. G: Good conditions; no haze, visibility about 40km (25 miles), overcast, no scintillation. Maximum ranges are achieved with Sokkia CP/AP prisms.
With CP01 compact prism		A: 1.3m (4.3ft.) to 700m (2,300ft.)
With one AP01 prism		A: 1.3m (4.3ft.) to 1,200m (3,900ft.), G: 1,500m (4,900ft.)
With three AP01 prism		A: 1.3m (4.3ft.) to 1,600m (5,200ft.), G: 2,000m (6,500ft.)
Distance unit		Meters or feet, selectable
Accuracy (Fine measurement)		±(3+2ppmxD)mm D=measuring range, unit=mm
Measuring unit and time (slope distance)	Fine	0.001 m Every 3.2 seconds (initial 4.7 seconds)
	Rapid	0.001 m 1.7 seconds
	Tracking	0.01 m Every 0.3 seconds (initial 1.4 seconds)
	Average	0.0001 m (average of 2 to 9 times measurement)
Atmospheric correction		Key-in the temperature and pressure, or -499 to +499ppm.
Prism constant		-99 to 0mm (1 mm steps)
Refraction & Earth-curvature correction		On/off selectable (K=0.142)
General		
Display		LCD dot matrix display (20 characters x 4 lines) on both faces with back light.
Keyboard		5 keys on both faces, free assignment of functions.
Resume function		On/off selectable
Sensitivity of levels		Plate level: 40"/2mm, Circular level: 10"/2mm (in tribrach)
Optical plummet		Image: erect, Magnification: 3x, Minimum focus: 0.5m (1.6ft.)
Interface		Asynchronous serial, RS-232C compatible, baud rate 1200/9600bps
2-way communication		Provided
Data storage		3,000-point data memory
Operating temperature		-20°C to +50°C (-4°F to +122°F)
Tilting/Trunnion axis height		236mm (9.3in) from tribrach bottom, 193mm (7.6in) from tribrach dish.
Size with handle and battery		W150 x D165 x H353mm, W5.9 x D6.5 x H13.9in.
Weight with handle and battery		5.4kg (11.9lbs)
Weight of parts		BDC25 battery: 240g (8.5oz.), Handle: 100g (3.5oz.), Tribrach: 740g (1.6 lbs), Case: 2.4kg (5.3lbs)
Power supplies		
Battery level display		4 steps with warning message.
Automatic power cut-off		On/off selectable (30 minutes after the last operation)
Power source		BDC25 rechargeable battery, Ni-Cd 6V, 2 supplied as standard.
Working duration at 25°C (77°F) w/one BDC25 battery		Distance & angle measurement: about 5 hours, about 600 points (Fine & single measurement with 30 seconds intervals). Angle measurement only: about 9 hours.
Charging time		CDC27/31: about 80 minutes, CDC31A: about 90 minutes

Designs and specifications are subject to change without notice.

## SOKKIA CO.,LTD.

1-1, TOMIGAYA I-CHOME, SHIBUYA-KU, TOKYO, 151 JAPAN  
PHONE +81-3-3465 5211 FAX +81-3-346-5203  
INTERNATIONAL DEPT. PHONE +81-3-346-5201 FAX +81-3-3465-5202



Sokkia is a sponsor of the International Federation of Surveyors.



## **Appendix III**

---

### **Vessel Reports, Offsets, and Diagrams**

#### **Launch 1010**

1. Offsets
2. Patch Test
3. DDSSM and Settlement & Squat
4. POS Gams Calibration
5. Wire Diagram

#### **Launch 1018**

1. Offsets
2. Patch Test
3. DDSSM and Settlement & Squat
4. POS Gams Calibration
5. Wire Diagram

#### **S220**

1. Offsets
2. Patch Test
3. DDSSM and Settlement & Squat
4. POS Gams Calibration
5. Wire Diagram
6. Correspondence

## **Appendix III**

---

### **Vessel Reports, Offsets, and Diagrams**

#### **Launch 1010**

1. Offsets
2. Wire Diagram
3. POS Gams Calibration
4. Patch Test
5. Dynamic Draft

#### **Launch 1018**

1. Offsets
2. Wire Diagram
3. POS Gams Calibration
4. Patch Test
5. Dynamic Draft

#### **Launch 2801**

1. Offsets
2. Wire Diagram
3. POS Gams Calibration (no documentation available)
4. Patch Test
5. Dynamic Draft

#### **Launch 2802**

1. Offsets
2. Wire Diagram
3. POS Gams Calibration (no documentation available)
4. Patch Test
5. Dynamic Draft

#### **S220**

1. Offsets
2. Wire Diagram
3. POS Gams Calibration
4. Patch Test
5. Dynamic Draft
6. Correspondence

### **Sounding System Comparison Apr-July 2009**

### **Coordinate Systems Utilized in Vessel Offsets**

### 1010 Offsets and Measurements - Summary

Measurement aka Coord. Sys.	IMU to RP*	8101 to RP*	IMU to 8101 <i>SWATH1 x,y,z &amp; MRU to Trans</i>		Port Ant to 8101 <i>Nav to Trans x,y,z</i>		RP* to Waterline	
	Caris	Caris		Caris		Caris		Caris
x	0.000	0.250		0.250		1.147		n/a
y	0.000	-0.133		-0.133		1.066		n/a
z	0.000	0.549		0.549		3.665		-0.256

\*IMU is RP (Reference Pt)

Vessel Offsets for 1010\_8101 are derived from the [Horizontal](#), [Vertical](#) & [XYZ](#) worksheets in this spreadsheet. 2008 Measured Values

#### Calculations

Coord. Sys.	8101 to RP*	IMU to 8101		Port Ant to 8101		RP to Waterline	
<a href="#">Theodolite</a>		IMU (m)	x 3.516	IMU (m)	x 3.516	IMU (m)	x 3.516
			y 0.011		y 0.011		y 0.011
			z -1.183		z -1.183		z -1.183
		BM H	x 3.271447	Port Antenna	x 2.317	BM C	x 0.000
			y 0.425598		y -0.886		y 0.000
			z -1.37667		z 1.933		z 0.000
		IMU to BM H	x -0.244	IMU to Port Antenna	x -1.199	BM C to IMU	x n/a
			y 0.415		y -0.897		y n/a
			z -0.194		z 3.116		z -1.183
		BM H to Phase Ctr measured (cm)	x 11.10496	IMU to Phase Ctr	x -0.133	BM C to Waterline measured	x n/a
			y -16.466		y 0.250		y n/a
			z -35.540		z -0.549		z -0.927
		BM H to Phase Ctr (m)	x 0.11105				
			y -0.16466				
			z -0.3554				

see

Coord. Sys.	IMU to 8101	IMU to 8101		Port Ant to 8101		RP to Waterline	
<a href="#">Theodolite</a>		IMU to	x -0.133		x 1.066		x n/a
		Phase Ctr	y 0.250		y 1.147		y n/a
			z -0.549		z -3.665		z 0.256
		Coord. Sys. <a href="#">CARIS</a>	x 0.250	Coord. Sys. <a href="#">CARIS</a>	x 1.147	Coord. Sys. <a href="#">CARIS</a>	x n/a
			y -0.133		y 1.066		y n/a
			z 0.549		z 3.665		z -0.256

### 1010 Offsets and Measurements - Summary

Port Ant to Stbd Ant		IMU to Port Antenna		IMU to Heave	
		Caris	Pos/Mv	Caris	Pos/Mv
Scalar Distance	1.839	-0.897	-1.199	-0.011	-1.176
		-1.199	-0.897	-1.176	-0.011
		-3.117	-3.117	-0.243	-0.243

Values in the POSMV remained as entered in 2008.

2009 Measured Values

2007 Measured Values

Port Ant to Stbd Ant			IMU to Port Antenna			IMU to Heave		
Port Ant (m)	x	2.317	IMU (m)	x	3.516	IMU (m)	y	0.011
	y	-0.886		y	0.011	x is n/a	z	-1.183
	z	1.933		z	-1.183	Heave Pt (m)		
Stbd Ant (m)	x	2.324	Port Ant (m)	x	2.317	(centerline)	y	0.000
	y	0.953		y	-0.886	BM C to Waterline (m)		-0.940
	z	1.918		z	1.934	measured scalar dist		
						BM C		
						x&y are n/a	z	0.000
						BM C to Waterline (m)		
						(Heave Pt)	z	-0.940
						IMU to LCG	x	-1.176
								<a href="#">See IMU to Heave tab</a>

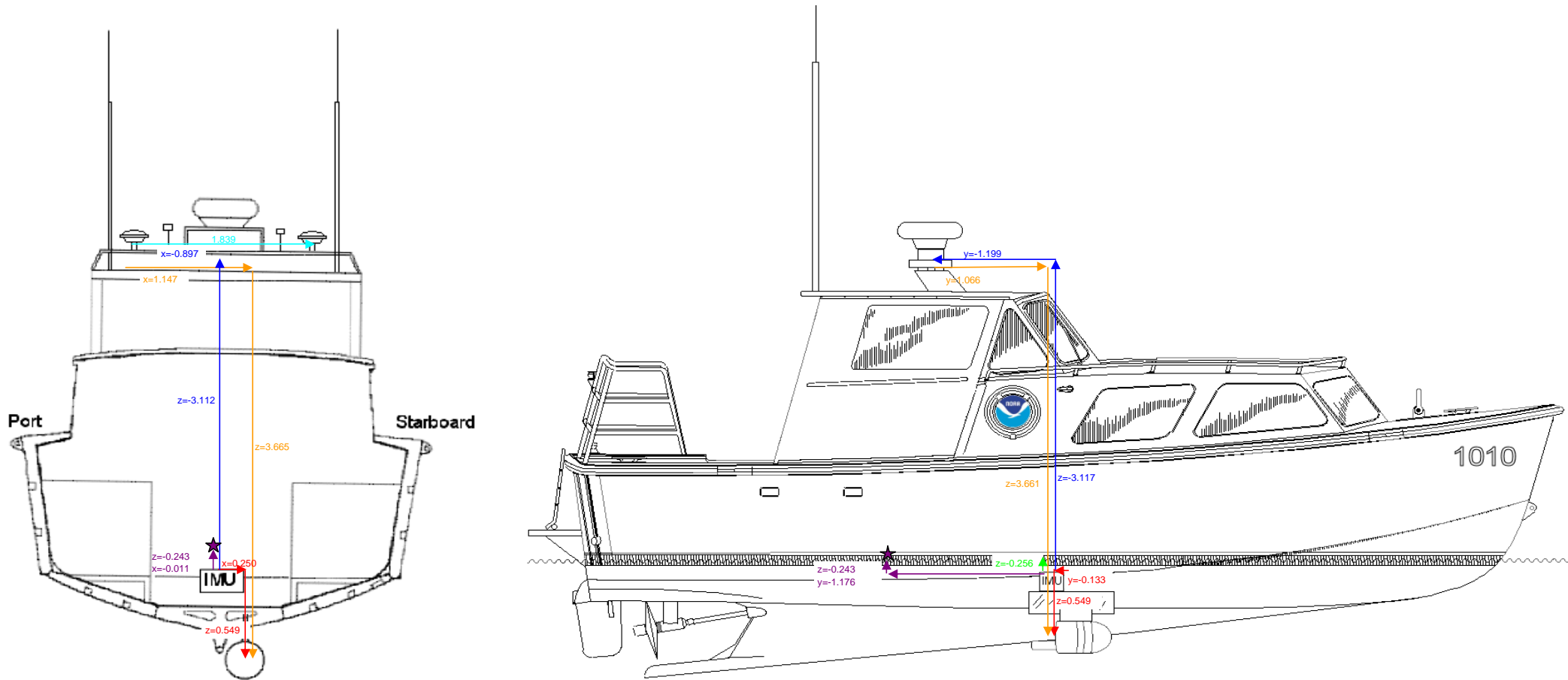
Port Ant to Stbd Ant		IMU to Port Antenna		IMU to Heave	
Scalar Distance	1.839				
		x	-1.199	x	-1.176
		y	-0.897	y	-0.011
		z	3.117	z	0.243
		Coord. Sys. <span style="color: green;">Pos/Mv</span>		Coord. Sys. <span style="color: green;">Pos/Mv</span>	
		x	-1.199	x	-1.176
		y	-0.897	y	-0.011
		z	-3.117	z	-0.243
					<a href="#">See IMU to Heave tab</a>



# Description of Offsets for Launch 1010

All Values Shown are in CARIS Coordinates

The Ship Reference Frame (SRF) for Launch 1010 was based from benchmark (BM) C as the 0 point. Physical locations were measured with x,y,z offsets from this point. These locations were used to calculate offsets of items with respect to each other, as described for each offset.



IMU to 8101		
x	y	z
0.250	-0.133	0.549

The physical positions of the IMU and the phase center of the 8101 with respect to the Ship Reference Frame were measured by NOAA personnel. These physical measurements were used to calculate the xyz offsets from the IMU to BM H. Measurements from BM H to the Phase Center of the 8101 were collected by NOAA personnel while the boat was secured on the pier and thought to be as level as possible. The measured offsets from BM H to the phase center were then added to the offset from the IMU to BM H. The result is the offset from the IMU to the phase center of the transducer. The values in the X and Y fields are transposed and the inverse of the Z value is used to give the offsets in CARIS coordinates.

Port Ant to 8101		
x	y	z
1.147	1.066	3.665

NOAA personnel calculated the distance between the port antenna and the phase center of the port antenna subtracting the IMU to Port Antenna value from the IMU to Phase Center value.

RP to Waterline		
x	y	z
N/A	N/A	-0.256

The average vertical distance from BM A and B to the waterline was measured by FAIRWEATHER personnel using a steel tape and bubble level. These values were used to calculate the BM C to the waterline value. With the knowledge of the BM C height above the IMU, the waterline height above the IMU could be calculated. On launch 1010, the IMU is used as the reference point.

Port Ant to Stbd Ant
Scalar Distance
1.839

The location of the phase center of the port and starboard POS/MV antennas were measured by NOAA personnel with respect to the SRF. The scalar distance between the phase centers was then calculated.

IMU to Port Antenna		
x	y	z
-0.897	-1.199	-3.117

The location of the IMU and the location of the port antenna were measured by NOAA personnel with respect to the Ship Reference Frame (SRF). The xyz offsets from the IMU to the port antenna could be calculated from these physical locations.

IMU to Heave		
x	y	z
-0.011	-1.176	-0.243

The heave point was positioned differently on each of the axes. The distance for the longitudinal axis was determined as described in the "IMU to Heave" tab in this workbook. The athwart ships axis was the vessel centerline. Lastly, the waterline was used as the height of the heave point, which was calculated earlier in 'RP to Waterline'.

## 1010 Offsets and Measurements IMU to Heave

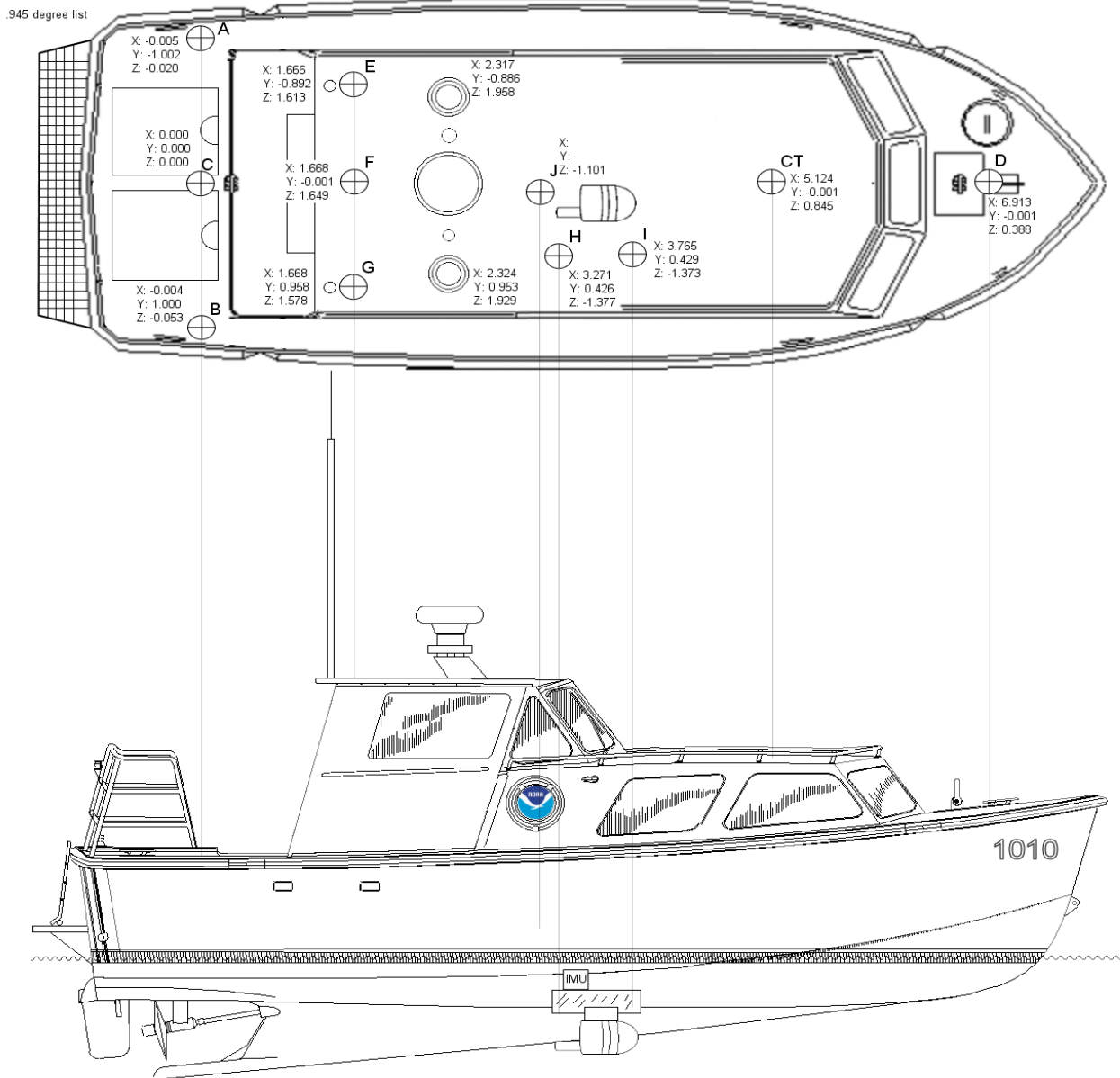
### IMU to Heave

Measurement	Explanation	Notes
BM C to BM D 6.913	From Offsets & Measurements XYZ.	Stability values are not available for Launch 1010 at this time. Values used are from Launch 1018*.
BM D to Center of Pick Point -0.275	Measured with steel tape 11/16/05.	LCG stands for logitudinal center of gravity, which was assumed to be the location of the heave point for the launch.
Center of Pick Point to Frame 0 0.5207	From JMC drawing. Converted to meters.	
BM C to Frame 0 7.1587	Calculated from cells 4, 7 and 10.	JMC refers to the Jensen Marine Consultants, Inc. report titled, "28' NOAA Survey Launch Stability Information Booklet," dated February 23, 2005*. There were several different values for the LCG in the JMC report, but the value used for these calculations was believed to be the most reasonable.
Frame 0 to LCG -4.818888	From JMC Stability Test. Converted to meters.	
BM C to LCG 2.339812	Calculated from cells 13 and 16.	
BM C to IMU 3.516	From Offsets & Measurements XYZ.	
IMU to LCG -1.176188	Calculated from cells 19 and 22.	

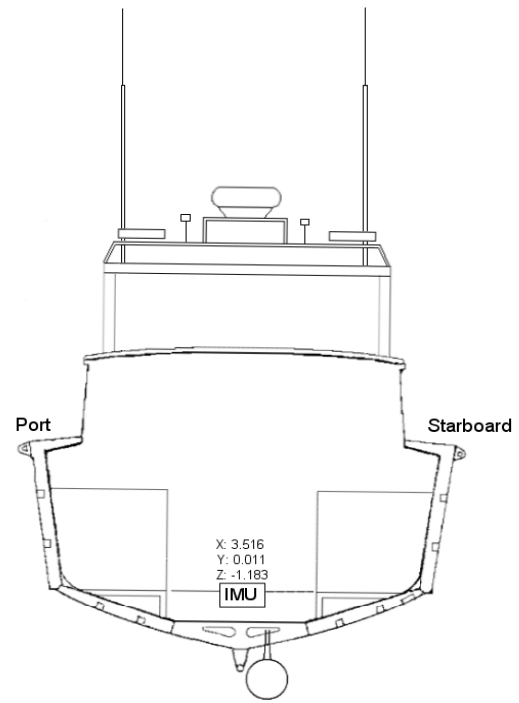
\* There was some confusion as to which boat had the stability testing done to it. This was due to the report listing it as 1010, but the CO (CAPT John Lowell at the time) and Steve Currie both assert that the testing was done to 1018.

# 1010 Vessel Diagram

All Values Shown are in Theodolite Coordinates



Note: Both antenna have been replaced for the POS V4. While their x-y values are not thought to have changed, the z-value has been remeasured.



## 1010 Offsets and Measurements - Summary

Port Ant to Stbd Ant		IMU to Port Antenna	
		Caris	Pos/Mv
Scalar Distance	1.839	-0.897	-1.199
		-1.199	-0.897
		-3.080	-3.080

**Antenna values after new installation of the same model antenna on August 23, 2009.**

(Values were used in the POSMV but not adjusted in the CARIS TPE Offset section of the hvf.)

2009 Measured Values

2007 Measured Values

Port Ant to Stbd Ant			IMU to Port Antenna		
Port Ant (m)	x	2.317	IMU (m)	x	3.516
	y	-0.886		y	0.011
	z	1.933		z	-1.183
Stbd Ant (m)	x	2.324	Port Ant (m)	x	2.317
	y	0.953		y	-0.886
	z	1.918		z	1.934
mount (m)	z	0.040	mount (m)	z	0.040
<i>removed</i>			<i>removed</i>		
washers (m)	z	0.003	washers (m)	z	0.003
<i>added</i>			<i>added</i>		
Port Ant (m)	x	2.317	Port Ant (m)	x	2.317
	y	-0.886		y	-0.886
	z	1.896		z	1.897
Stbd Ant (m)	x	2.324			
	y	0.953			
	z	1.882			

Port Ant to Stbd Ant		IMU to Port Antenna	
Scalar Distance	1.839	x	-1.199
		y	-0.897
		z	3.080
		Coord. Sys. <span style="color: green;">Pos/Mv</span>	
		x	-1.199
		y	-0.897
		z	-3.080

## Waterline Measurements

Measuring Party: Rice, Argento, Campbell, Beduhn

Waterline Measurements should be Negative!

<b>1010</b>		
	Benchmark A to Waterline	Benchmark B to Waterline
Measure 1	-86.2	-88.5
Measure 2	-86.6	-89.2
Measure 3	-87.6	-96.0
Avg (cm)	-86.80	-91.23
Avg (m)	-0.8680	-0.9123

Stdev                      0.00721                      0.04143

BM Z-value (m)            -0.02017                      -0.05283

BM C to WL (m)           -0.888                         -0.965

Individual measurement            -0.88217                      -0.93783  
    -0.88617                      -0.94483

StDev for TPU xls     0.04986            -0.89617                      -1.01283  
 (of 6 #'s)

**Fill in Yellow squares only!**

Date: 4/7/2009 Dn 097

Fuel Level: .5+

Draft Tube:  

Port-to-Stbd Z-difference

	Theoretical	Actual	Error
	0.0327	-0.0443	-0.0770

BM C to WL Average (m)

-0.927 (This value added to 1010\_Offsets & Measurements\_200X.xls)

utilized in Offsets and Measurements and TPU spreadsheet

This spreadsheet is designed to compute the z-values of the phase centers of the new POS M/V antenna.

**All offsets are in the Theodolite Coordinate System**

BM E	x	1.665536
	y	-0.892424
	z	1.612667
BM F	x	1.668082
	y	-0.001217
	z	1.649000
BM G	x	1.668115
	y	0.957794
	z	1.578000

Port Ant	x	2.316862
	y	-0.886431
	z	Unknown
Stbd Ant	x	2.324270
	y	0.952574
	z	Unknown

**POS MV V4 Installation and Operation Guide**

Drawings

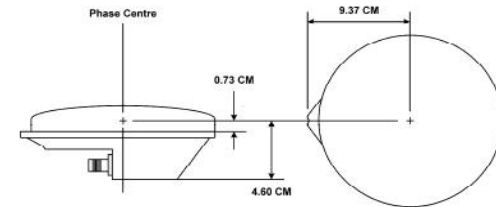


Figure 79: GPS Antenna Footprint

**Measuring Party (fill in yellow spaces only):**

Rice, Argento, Campbell, Beduhn

**Date:**

4/7/2009

**Serial #- Port**

60162863

**Serial #- Stbd**

60145247

**Distances**

Port Ant to BM 'E'	0.693	0.693	0.693	0.70575
Port Ant to BM 'F'	1.11	1.11	1.112	1.1234167
Port Ant to BM 'G'	1.967	1.97	1.97	1.98175

Stbd Ant to BM 'E'	1.959	1.964	1.962	1.9744167
Stbd Ant to BM 'F'	1.166	1.167	1.167	1.1794167
Stbd Ant to BM 'G'	0.707	0.705	0.705	0.7184167

**Antenna Post**

Diameter	Radius
0.0255	0.01275

**z-Values**

Ant. Base	Phase Center
1.884369	1.930369
1.888889	1.934889
1.902489	1.948489
1.886629	1.932629
AVERAGE	
0.0094 STDEV	
1.858381	1.904381
1.874221	1.920221
1.870499	1.916499
1.872360	1.918360
AVERAGE	
0.0083 STDEV	

The distances from the antenna post to each benchmark was measured three times and averaged. The post offset to phase center (radius) was then added.

The distance is 0.046m (4.60cm) from the bottom of the antenna to the Phase center, obtained from the POSM/V4 guide, see image above.

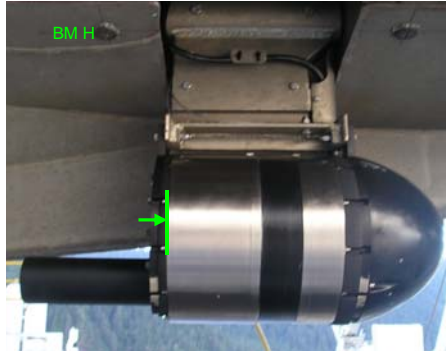
# Offsets from Aft Benchmark to Phase Center of Transducer

3/20/2009	79	Launch 1010	Campbell, Argento, Beduhn
Date	DN	Vessel	Personnel

2701011
Serial Number of Transducer

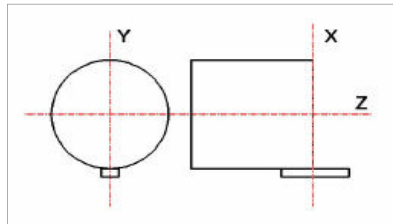
**Instructions:** The purpose of this measurement is to check for gross movement of the transducer. **Fill in yellow spaces only.**

While the boat is in the cradle, gently lower the transducer and lock it in place. Using a metric tape measure, plumb bob and carpenter's level, measure the horizontal and vertical offsets from the aft benchmark (BM H) to the phase center of the transducer. The phase center is measured at the forward edge of the black insulating layer, as shown in the photos. If you have trouble locating the center, borrow a compass from the navigation department.



Notwithstanding a major accident, BM H will be outboard, aft and higher than the phase center; as such, enter all offsets as positive numbers (in cm) and the proper signs will be applied.

Once offsets have been measured, apply a digital level to the IMU to determine any pitch or roll bias in the orientation of the launch. For the purposes of this spreadsheet, a positive angle (measured in degrees) will imply the bow is higher than the stern and the port side is higher than the starboard side.



All measurements should be done in triplicate to aid in the calculation of the uncertainty (needed in the HVF). The *IMU to Phase Center* values will be calculated automatically.

Offset Measurements (positive cm):				Average
Bow-Stern	10.6	10.7	11.0	10.8
Port-Stbd	15.9	15.9	15.8	15.9
Up-Down	35.5	35.4	36.0	35.6

Angle Bias (deg):	
Bow Up	
Port Up	

The measuring crew should insure there will be no yaw bias.

Std Dev:	
Bow-Stern	0.21
Port-Stbd	0.06
Up-Down	0.32

BM H to Phase Center	
(Theodolite Coordinate System)	
x	10.767 cm
y	-15.867 cm
z	-35.633 cm

Measured by NOAA Personnel inserted into Offset Worksheet, if to be used in IMU to 8101 calculation

IMU to Phase Center	
(CARIS Coordinate System)	
x	0.256 m
y	-0.136 m
z	0.550 m

Calculated Value for check purposes

**These 2009 values were not used for the hvf offsets due to the angle bias not being entered. The 2008 values were used instead and the 2009 values were used as a check that the unit had not been displaced.**

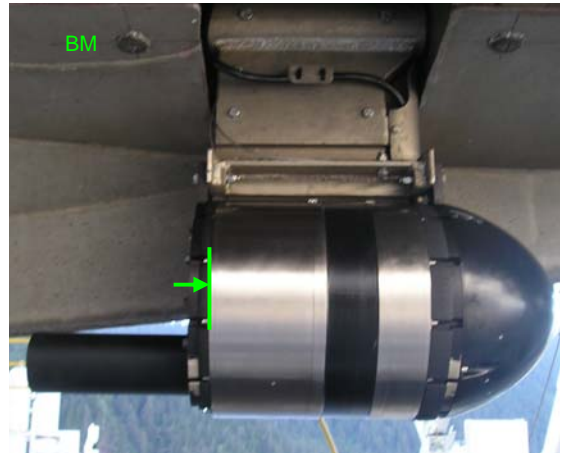


# Offsets from Aft Benchmark to Phase Center of Transducer

4/15/2008	106	1010	Breen
Date	DN	Vessel	Personnel

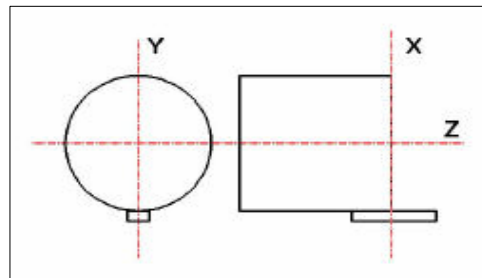
**Instructions:** The purpose of this measurement is to check for gross movement of the transducer.

While the boat is in the cradle, gently lower the transducer and lock it in place. Using a metric tape measure, plumb bob and carpenter's level, measure the horizontal and vertical offsets from the aft benchmark (BM H) to the phase center of the transducer. The phase center is measured at the forward edge of the black insulating layer, as shown in the photos. If you have trouble locating the center, borrow a compass from the navigation department.



Notwithstanding a major accident, BM H will be outboard, aft and higher than the phase center; as such, enter all offsets as positive numbers (in cm) and the proper signs will be applied.

Once offsets have been measured, apply a digital level to the IMU to determine any pitch or roll bias in the orientation of the launch. For the purposes of this spreadsheet, a positive angle (measured in degrees) will imply the bow is higher than the stern and the port side is higher than the starboard side.



All measurements should be done in triplicate to aid in the calculation of the uncertainty (needed in the HVF). The *IMU to Phase Center* values will be calculated automatically.

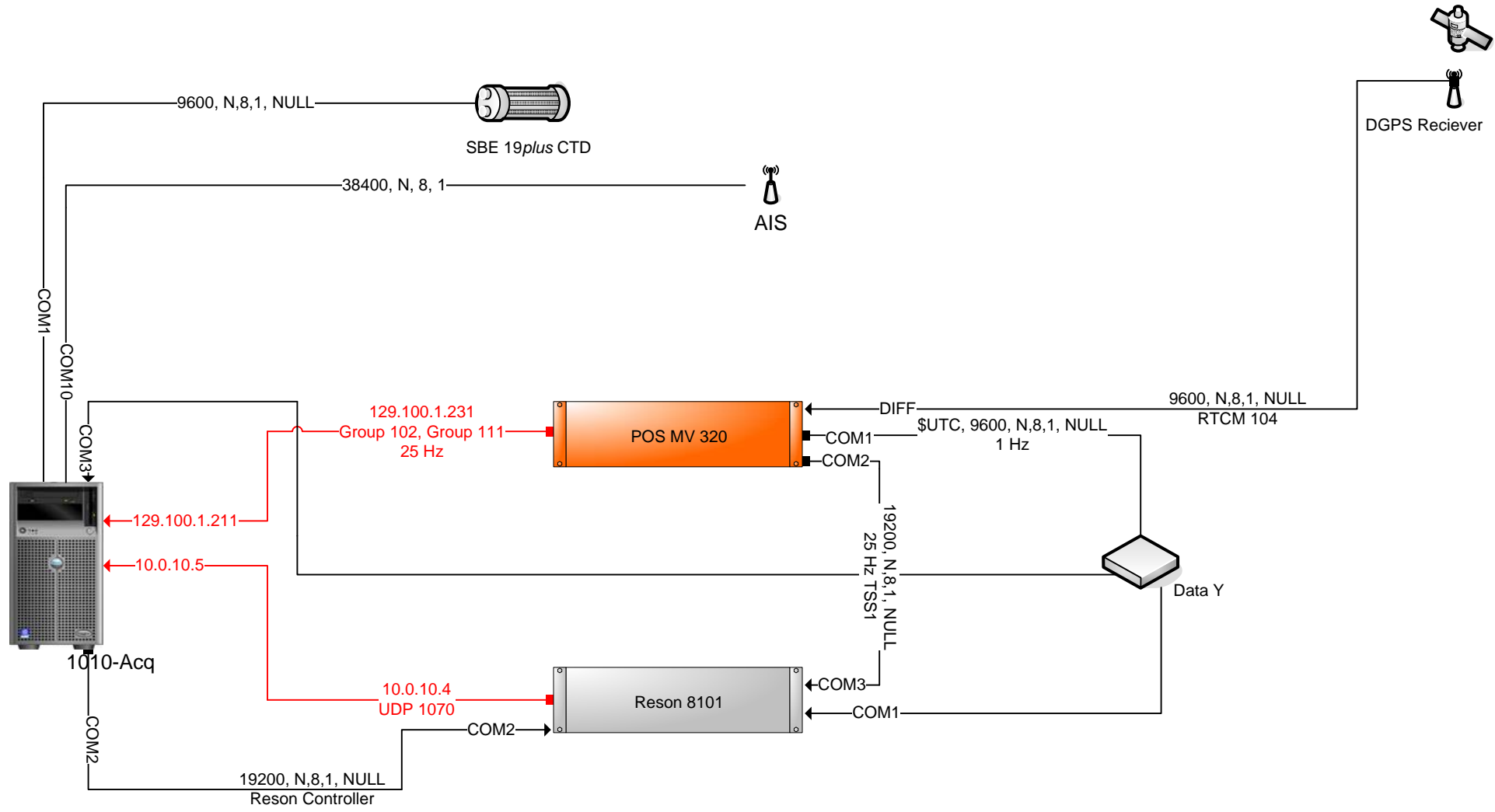
Offset Measurements (positive cm):				Average
Bow-Stern	10.1	10.2	10.4	10.2
Port-Stbd	15.1	15.2	15.7	15.3
Up-Down	36.0	36.4	36.5	36.3

Angle Bias (deg):	
Bow Up	-1.4
Port Up	-1.8

The measuring crew should insure there will be no yaw bias.

BM H to Phase Center	
(Theodolite Coordinate System)	
x	11.105 cm
y	-16.466 cm
z	-35.540 cm

IMU to Phase Center	
(CARIS Coordinate System)	
x	0.250 m
y	-0.133 m
z	0.549 m



Key

—	Serial
—	Crossover
—	Patch

Launch 1010 Wire Diagram		
Rev 3.0	12 July 2009	LT Ringel

# NOAA POS/MV Calibration Report

**Fill out all fields!** See previous years as an example.

**Yellow areas require screen grabs!**

Ship: FAIRWEATHER

Vessel: 1010

Date: 4/15/2009

Dn: 105

Personnel: W Renoud, L Morgan, T Beduhn

PCS Serial # 2564

IMU Serial # 294

IP Address: 129.100.1.231

Port Antenna Serial # 60162863

Stbd Antenna Serial # 60145247

POS controller Version (Use Menu Help > About) 3.4.0.0

POS Version (Use Menu View > Statistics) MV-320,VER4,S/N2564,HW2.6-7,SW03.42-May28/07,ICD03.25,OS425B14,IMU2,PGPS13,SGPS13,RTK-0,THV-0,DPW-0

**GPS Receivers**

Primary Receiver Serial #: 4624A70264

Secondary Receiver Serial #: 4622A68956

**Statistics**

**POS Version**  
MV-320,VER4,S/N2564,HW2.6-7,SW03.42-May28/07,ICD03.25,OS425B14,IMU2,PGPS13,SGPS13,RTK-0,THV-0,DPW-0

**GPS Receivers**

**Primary Receiver**  
BD950 SN:4624A70264, v.00211, channels:24

**Secondary Receiver**  
BD950 SN:4622A68956, v.00211, channels:24

Statistics	
Total Hours	<b>1315.0</b>
Total Runs	<b>275</b>
Average Run (hours)	<b>4.8</b>
Longest Run (hours)	<b>41.0</b>
Current Run (hours)	<b>4.2</b>

**Calibration area**

Location: Lake Washington, N of Sandpoint

Approximate Position: \_\_\_\_\_ Lat  
 \_\_\_\_\_ Lon

47	43	41
122	16	30

DGPS Beacon Station: Whidbey

DGPS Receiver Serial#: 0331-12579-0008

Frequency: 302HZ



# POS/MV Calibration

## Calibration Procedure:

(Refer to POS MV V4 Installation and Operation Guide, 4-25)

Start time: \_\_\_\_\_

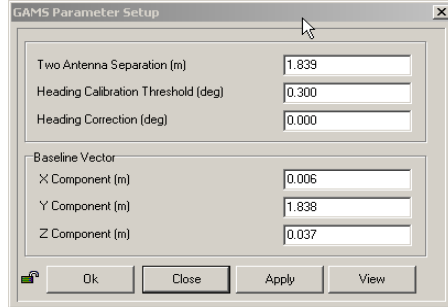
End time: \_\_\_\_\_

Heading accuracy achieved for calibration: 0.091°

## Calibration Results:

### Gams Parameter Setup

(Use Settings > Installation > GAMS Intallation)



GAMS Status Online X

Save Settings X

## Calibration Notes:

\_\_\_\_\_  
\_\_\_\_\_  
\_\_\_\_\_

## Save POS Settings on PC

(Use File > Store POS Settings on PC)

File Name: 1010\_Dn105\_POS\_Config\_new.nvm

## General Notes:

**The POS/MV uses a Right-Hand Orthogonal Reference System**  
The right-hand orthogonal system defines the following:

- The x-axis is in the fore-aft direction in the appropriate reference frame.
- The y-axis is perpendicular to the x-axis and points towards the right (starboard) side in the appropriate reference frame.
- The z-axis points downwards in the appropriate reference frame.

**The POS/MV uses a Tate-Bryant Rotation Sequence**  
Apply the rotation in the following order to bring the two frames of reference into complete alignment:

- a) Heading rotation - apply a right-hand screw rotation  $\theta_z$  about the z-axis to align one frame with the other.
- b) Pitch rotation - apply a right-hand screw rotation  $\theta_y$  about the once-rotated y-axis to align one frame with the other.
- c) Roll rotation - apply a right-hand screw rotation  $\theta_x$  about the twice-rotated x-axis to align one frame with the other.

# SETTINGS

## Input/Output Ports

(Use Settings > Input/Output Ports)

COM1

Input/Output Ports Set-up

COM1 | COM2 | COM3 | COM4 | COM5

Baud Rate: 9600

Parity:  None  Even  Odd

Data Bits:  7 Bits  8 Bits

Stop Bits:  1 Bit  2 Bits

Flow Control:  None  Hardware  XON/XOFF

Output Select: NMEA

NMEA Output:

- \$INRST
- \$INGGA
- \$INRDT
- \$INZDA
- \$INVTG
- \$PASHR

Update Rate: 1 Hz

Talker ID: IN

Roll Positive Sense:  Port Up  Starboard Up

Pitch Positive Sense:  Bow Up  Stem Up

Heave Positive Sense:  Heave Up  Heave Down

Input Select: None

Close Apply

COM2

Input/Output Ports Set-up

COM1 | COM2 | COM3 | COM4 | COM5

Baud Rate: 19200

Parity:  None  Even  Odd

Data Bits:  7 Bits  8 Bits

Stop Bits:  1 Bit  2 Bits

Flow Control:  None  Hardware  XON/XOFF

Output Select: Binary

Update Rate: 25 Hz

Frame:  Sensor 1  Sensor 2

Formula Select: TSS1

Roll Positive Sense:  Port Up  Starboard Up

Pitch Positive Sense:  Bow Up  Stem Up

Heave Positive Sense:  Heave Up  Heave Down

Input Select: None

Close Apply

COM3

Input/Output Ports Set-up

COM1 | COM2 | COM3 | COM4 | COM5

Baud Rate: 9600

Parity:  None  Even  Odd

Data Bits:  7 Bits  8 Bits

Stop Bits:  1 Bit  2 Bits

Flow Control:  None  Hardware  XON/XOFF

Output Select: None

Input Select: Base 1 GPS

Input Type: RTCM 1 or 9

Line:  Serial  Modem

Modem Settings

Close Apply

COM4

Input/Output Ports Set-up

COM1 | COM2 | COM3 | COM4 | COM5

Baud Rate: 9600

Parity:  None  Even  Odd

Data Bits:  7 Bits  8 Bits

Stop Bits:  1 Bit  2 Bits

Flow Control:  None  Hardware  XON/XOFF

Output Select: NMEA

NMEA Output:

- \$GPGST
- \$GPGGA
- \$GPHDT
- \$GPRDA
- \$GPVTG
- \$PASHR

Update Rate: 1 Hz

Talker ID: GP

Roll Positive Sense:  Port Up  Starboard Up

Pitch Positive Sense:  Bow Up  Stem Up

Heave Positive Sense:  Heave Up  Heave Down

Input Select: None

Close Apply

COM5

Input/Output Ports Set-up

COM1 | COM2 | COM3 | COM4 | COM5

Baud Rate: 9600

Parity:  None  Even  Odd

Data Bits:  7 Bits  8 Bits

Stop Bits:  1 Bit  2 Bits

Flow Control:  None  Hardware  XON/XOFF

Output Select: None

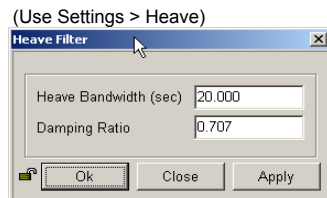
Input Select: None

Close Apply

## SETTINGS Continued

### Heave Filter

(Use Settings > Heave)



Heave Filter

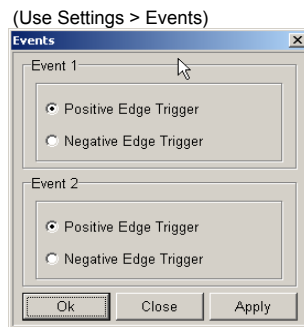
Heave Bandwidth (sec) 20.000

Damping Ratio 0.707

Ok Close Apply

### Events

(Use Settings > Events)



Events

Event 1

Positive Edge Trigger

Negative Edge Trigger

Event 2

Positive Edge Trigger

Negative Edge Trigger

Ok Close Apply

### Time Sync

(Use Settings > Time Sync)

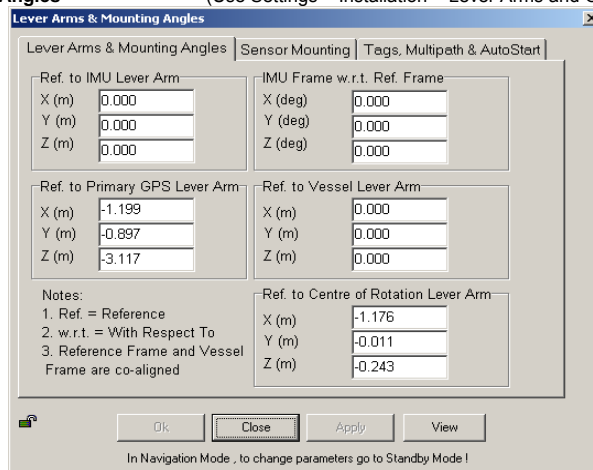
User Time Conversion (Units/Sec.)

## INSTALLATION

(Use Settings > Installation)

### Lever Arms and Mounting Angles

(Use Settings > Installation > Lever Arms and Offsets)



Lever Arms & Mounting Angles

Sensor Mounting | Tags, Multipath & AutoStart

Ref. to IMU Lever Arm

X (m)	0.000
Y (m)	0.000
Z (m)	0.000

IMU Frame w.r.t. Ref. Frame

X (deg)	0.000
Y (deg)	0.000
Z (deg)	0.000

Ref. to Primary GPS Lever Arm

X (m)	-1.199
Y (m)	-0.897
Z (m)	-3.117

Ref. to Vessel Lever Arm

X (m)	0.000
Y (m)	0.000
Z (m)	0.000

Notes:

1. Ref. = Reference
2. w.r.t. = With Respect To
3. Reference Frame and Vessel Frame are co-aligned

Ref. to Centre of Rotation Lever Arm

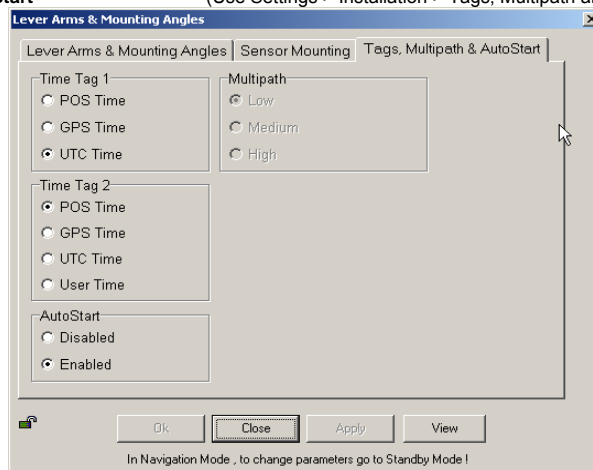
X (m)	-1.176
Y (m)	-0.011
Z (m)	-0.243

Ok Close Apply View

In Navigation Mode , to change parameters go to Standby Mode !

### Tags, Multipath and Auto Start

(Use Settings > Installation > Tags, Multipath and Auto Start)



Lever Arms & Mounting Angles

Sensor Mounting | Tags, Multipath & AutoStart

Time Tag 1

POS Time

GPS Time

UTC Time

Time Tag 2

POS Time

GPS Time

UTC Time

User Time

AutoStart

Disabled

Enabled

Multipath

Low

Medium

High

Ok Close Apply View

In Navigation Mode , to change parameters go to Standby Mode !

**Sensor Mounting**

(Use Settings > Installation > Sensor Mounting)

**Lever Arms & Mounting Angles**

Sensor Mounting | Tags, Multipath & AutoStart

Ref. to Aux. 1 GPS Lever Arm  
 X (m) 0.000  
 Y (m) 0.000  
 Z (m) 0.000

Ref. to Aux. 2 GPS Lever Arm  
 X (m) 0.000  
 Y (m) 0.000  
 Z (m) 0.000

Ref. to Sensor 1 Lever Arm  
 X (m) 0.000  
 Y (m) 0.000  
 Z (m) 0.000

Sensor 1 Frame w.r.t. Ref. Frame  
 X (deg) 0.000  
 Y (deg) 0.000  
 Z (deg) 0.000

Ref. to Sensor 2 Lever Arm  
 X (m) 0.000  
 Y (m) 0.000  
 Z (m) 0.000

Sensor 2 Frame w.r.t. Ref. Frame  
 X (deg) 0.000  
 Y (deg) 0.000  
 Z (deg) 0.000

Ok Close Apply View

In Navigation Mode , to change parameters go to Standby Mode !

**User Parameter Accuracy**

(Use Settings > Installation > User Accuracy)

**User Parameter Accuracy**

RMS Accuracy

Attitude (deg) 0.050  
 Heading (deg) 0.050  
 Position (m) 2.000  
 Velocity (m/s) 0.500

Ok Close Apply

**Frame Control**

(Use Tools > Config)

User Frame      Primary GPS Measurement

IMU Frame      Auxiliary GPS Measurement

Use GAMS enabled

**GPS Receiver Configuration**

(Use Settings> Installation> GPS Receiver Configuration)

**Primary GPS Receiver**

**Gps Receiver Configuration**

Primary GPS Receiver | Secondary GPS Receiver

Primary GPS  
 GPS Output Rate: 1 Hz

GPS 1 Port  
 Baud Rate: 9600

Parity:  None  Even  Odd  
 Data Bits:  7 Bits  8 Bits  2 Bits  
 Stop Bits:  1 Bit  2 Bits

Auto Configuration:  Enabled  Disabled

Ok Close Apply

**Secondary GPS Receiver**

**Gps Receiver Configuration**

Primary GPS Receiver | Secondary GPS Receiver

Secondary GPS  
 GPS Output Rate: 1 Hz

GPS 2 Port  
 Baud Rate: 9600

Parity:  None  Even  Odd  
 Data Bits:  7 Bits  8 Bits  2 Bits  
 Stop Bits:  1 Bit  2 Bits

Auto Configuration:  Enabled  Disabled

Ok Close Apply



# NOAA POS/MV Calibration Report

Fill out all fields! See previous years as an example.

Yellow areas require screen grabs!

Ship: FAIRWEATHER

Vessel: 1010

Date: 8/23/2009

Dn: 235

Personnel: Welten, Rice, Beduhn, Mallory

PCS Serial # 2564

IMU Serial # 294

IP Address: 129.100.1.231

Port Antenna Serial # 60268090

Stbd Antenna Serial # 60078644

POS controller Version (Use Menu Help > About) 3.4.0.0

POS Version (Use Menu View > Statistics) MV-320,VER4,S/N2564,HW2.6-7,SW03.42-May28/07,ICD03.25,OS425B14,IMU2,PGPS13,SGPS13,RTK-0,THV-0,DPW-0

## GPS Receivers

Primary Receiver Serial #: 4624A70264

Secondary Receiver Serial #: 4622A68956

Statistics

POS Version  
MV-320,VER4,S/N2564,HW2.6-7,SW03.42-May28/07,ICD03.25,OS425B14,IMU2,PGPS13,SGPS13,RTK-0,THV-0,DPW-0

GPS Receivers

Primary Receiver  
BD950 SN:4624A70264, v.00211, channels:24

Secondary Receiver  
BD950 SN:4622A68956, v.00211, channels:24

Statistics

Total Hours	1409.8
Total Runs	293
Average Run (hours)	4.8
Longest Run (hours)	41.0
Current Run (hours)	0.3

Close

## Calibration area

Location: Port Graham, Katchemak Bay

Approximate Position: \_\_\_\_\_ Lat  
\_\_\_\_\_ Lon

59/ 21.625 N
151/ 50.546 W

DGPS Beacon Station: Kenai

DGPS Receiver Serial#: 0331-12579-0008

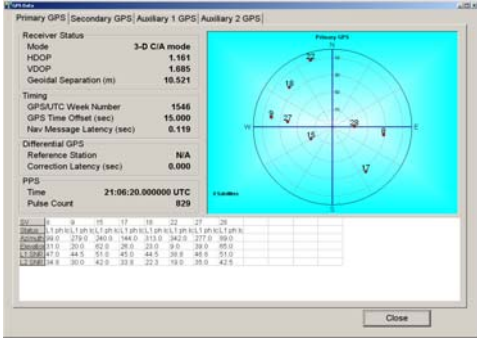
Frequency: 310HZ

**Satellite Constellation**

(Use View> GPS Data)

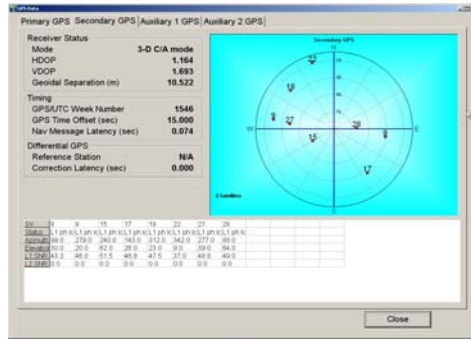
**Primary GPS**

Insert screen grabs



**Secondary GPS**

Note any differences from Primary GPS Receiver



**PDOP**

(Use View> GAMS Solution)

**POS/MV Configuration Settings**

**Gams Parameter Setup**

(Use Settings > Installation > GAMS Installation)

GAMS Parameter Setup

Two Antenna Separation (m) 1.837

Heading Calibration Threshold (deg) 0.300

Heading Correction (deg) 0.000

Baseline Vector

X Component (m) 0

Y Component (m) 0

Z Component (m) 0

Ok Close Apply View

**Configuration Notes:**

**POS/MV Calibration**

**Calibration Procedure:**

(Refer to POS MV V4 Installation and Operation Guide, 4-25)

Start time: 1330

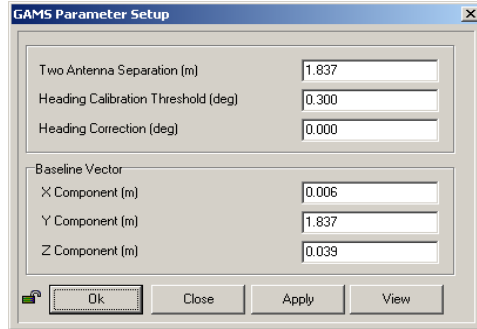
End time: 1400

Heading accuracy achieved for calibration: 0.021

**Calibration Results:**

**Gams Parameter Setup**

(Use Settings > Installation > GAMS Intallation)



GAMS Status Online

X

Save Settings

X

**Calibration Notes:**

---

---

---

**Save POS Settings on PC**

(Use File > Store POS Settings on PC)

File Name: \_\_\_\_\_

**General Notes:**

**The POS/MV uses a Right-Hand Orthogonal Reference System**  
The right-hand orthogonal system defines the following:

- The x-axis is in the fore-aft direction in the appropriate reference frame.
- The y-axis is perpendicular to the x-axis and points towards the right (starboard) side in the appropriate reference frame.
- The z-axis points downwards in the appropriate reference frame.

**The POS/MV uses a Tate-Bryant Rotation Sequence**  
Apply the rotation in the following order to bring the two frames of reference into complete alignment:

- a) Heading rotation - apply a right-hand screw rotation  $\theta_z$  about the z-axis to align one frame with the other.
- b) Pitch rotation - apply a right-hand screw rotation  $\theta_y$  about the once-rotated y-axis to align one frame with the other.
- c) Roll rotation - apply a right-hand screw rotation  $\theta_x$  about the twice-rotated x-axis to align one frame with the other.

# SETTINGS

## Input/Output Ports

(Use Settings > Input/Output Ports)

COM1

Input/Output Ports Set-up

COM1 | COM2 | COM3 | COM4 | COM5

Baud Rate: 9600

Parity:  None  Even  Odd

Data Bits:  7 Bits  8 Bits

Stop Bits:  1 Bit  2 Bits

Flow Control:  None  Hardware  XON/XOFF

Output Select: NMEA

NMEA Output:

- \$INCSST
- \$INOGA
- \$INHDY
- \$INZDA
- \$INVTG
- \$PASHR

Update Rate: 1 Hz

Talker ID: N

Roll Positive Sense:  Port Up  Starboard Up

Pitch Positive Sense:  Bow Up  Stern Up

Heave Positive Sense:  Heave Up  Heave Down

Input Select: None

Close Apply

COM2

Input/Output Ports Set-up

COM1 | COM2 | COM3 | COM4 | COM5

Baud Rate: 19200

Parity:  None  Even  Odd

Data Bits:  7 Bits  8 Bits

Stop Bits:  1 Bit  2 Bits

Flow Control:  None  Hardware  XON/XOFF

Output Select: Binary

Update Rate: 25 Hz

Formula Select: TSS1

Frame:  Sensor 1  Sensor 2

Roll Positive Sense:  Port Up  Starboard Up

Pitch Positive Sense:  Bow Up  Stern Up

Heave Positive Sense:  Heave Up  Heave Down

Input Select: None

Close Apply

COM3

Input/Output Ports Set-up

COM1 | COM2 | COM3 | COM4 | COM5

Baud Rate: 9600

Parity:  None  Even  Odd

Data Bits:  7 Bits  8 Bits

Stop Bits:  1 Bit  2 Bits

Flow Control:  None  Hardware  XON/XOFF

Output Select: None

Input Select: Base GPS Input

Line: Dase 1 GPS

Input Type: RTCM 1 or 9

Serial  Modem

Modem Settings

Close Apply

COM4

Input/Output Ports Set-up

COM1 | COM2 | COM3 | COM4 | COM5

Baud Rate: 9600

Parity:  None  Even  Odd

Data Bits:  7 Bits  8 Bits

Stop Bits:  1 Bit  2 Bits

Flow Control:  None  Hardware  XON/XOFF

Output Select: NMEA

NMEA Output:

- \$GPGST
- \$GPGGA
- \$GPHDT
- \$GPDZA
- \$GPVTG
- \$PASHR

Update Rate: 1 Hz

Talker ID: GP

Roll Positive Sense:  Port Up  Starboard Up

Pitch Positive Sense:  Bow Up  Stern Up

Heave Positive Sense:  Heave Up  Heave Down

Input Select: None

Close Apply

COM5

Input/Output Ports Set-up

COM1 | COM2 | COM3 | COM4 | COM5

Baud Rate: 9600

Parity:  None  Even  Odd

Data Bits:  7 Bits  8 Bits

Stop Bits:  1 Bit  2 Bits

Flow Control:  None  Hardware  XON/XOFF

Output Select: None

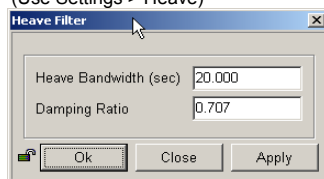
Input Select: None

Close Apply

## SETTINGS Continued

### Heave Filter

(Use Settings > Heave)



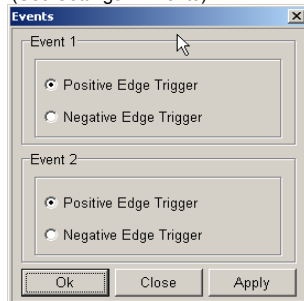
Heave Filter dialog box with the following fields:

Heave Bandwidth (sec)	20.000
Damping Ratio	0.707

Buttons: Ok, Close, Apply

### Events

(Use Settings > Events)



Events dialog box with two event configurations:

Event 1

- Positive Edge Trigger
- Negative Edge Trigger

Event 2

- Positive Edge Trigger
- Negative Edge Trigger

Buttons: Ok, Close, Apply

### Time Sync

(Use Settings > Time Sync)

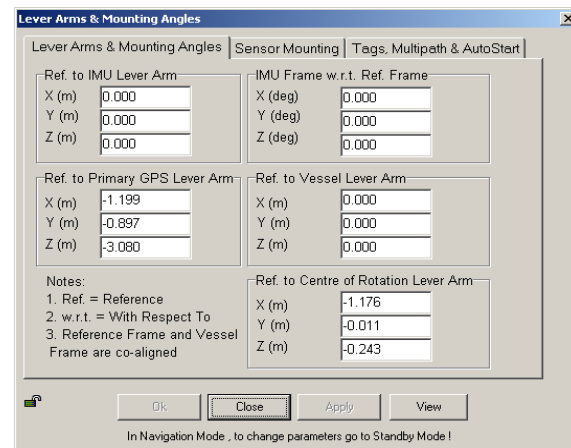
User Time Conversion (Units/Sec.)

## INSTALLATION

(Use Settings > Installation)

### Lever Arms and Mounting Angles

(Use Settings > Installation > Lever Arms and Offsets)



Lever Arms & Mounting Angles dialog box with the following sections:

- Ref. to IMU Lever Arm:** X (m) 0.000, Y (m) 0.000, Z (m) 0.000
- IMU Frame w.r.t. Ref. Frame:** X (deg) 0.000, Y (deg) 0.000, Z (deg) 0.000
- Ref. to Primary GPS Lever Arm:** X (m) -1.199, Y (m) -0.897, Z (m) -3.080
- Ref. to Vessel Lever Arm:** X (m) 0.000, Y (m) 0.000, Z (m) 0.000
- Ref. to Centre of Rotation Lever Arm:** X (m) -1.176, Y (m) -0.011, Z (m) -0.243

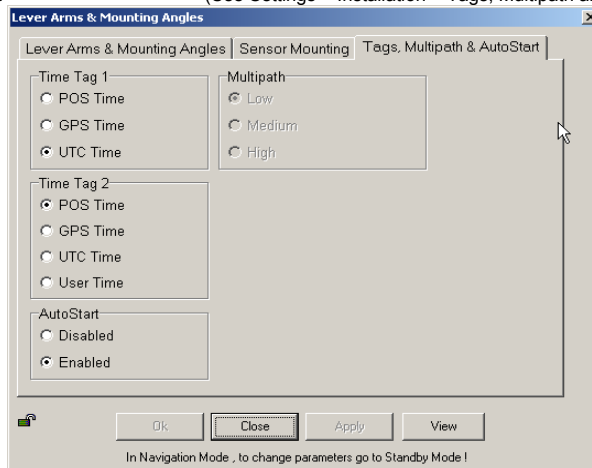
Notes:  
1. Ref. = Reference  
2. w.r.t. = With Respect To  
3. Reference Frame and Vessel Frame are co-aligned

Buttons: Ok, Close, Apply, View

In Navigation Mode, to change parameters go to Standby Mode!

### Tags, Multipath and Auto Start

(Use Settings > Installation > Tags, Multipath and Auto Start)



Tags, Multipath and Auto Start dialog box with the following sections:

- Time Tag 1:**  POS Time,  GPS Time,  UTC Time
- Time Tag 2:**  POS Time,  GPS Time,  UTC Time,  User Time
- AutoStart:**  Disabled,  Enabled
- Multipath:**  Low,  Medium,  High

Buttons: Ok, Close, Apply, View

In Navigation Mode, to change parameters go to Standby Mode!

**Sensor Mounting**

(Use Settings > Installation > Sensor Mounting)

**Lever Arms & Mounting Angles**

Lever Arms & Mounting Angles		Sensor Mounting		Tags, Multipath & AutoStart	
Ref. to Aux. 1 GPS Lever Arm			Ref. to Aux. 2 GPS Lever Arm		
X (m)	0.000	X (m)	0.000	Y (m)	0.000
Y (m)	0.000	Y (m)	0.000	Z (m)	0.000
Z (m)	0.000	Z (m)	0.000		
Ref. to Sensor 1 Lever Arm			Sensor 1 Frame w.r.t. Ref. Frame		
X (m)	0.000	X (deg)	0.000	Y (deg)	0.000
Y (m)	0.000	Y (deg)	0.000	Z (deg)	0.000
Z (m)	0.000	Z (deg)	0.000		
Ref. to Sensor 2 Lever Arm			Sensor 2 Frame w.r.t. Ref. Frame		
X (m)	0.000	X (deg)	0.000	Y (deg)	0.000
Y (m)	0.000	Y (deg)	0.000	Z (deg)	0.000
Z (m)	0.000	Z (deg)	0.000		

Ok Close Apply View

In Navigation Mode , to change parameters go to Standby Mode !

**User Parameter Accuracy**

(Use Settings > Installation > User Accuracy)

**User Parameter Accuracy**

RMS Accuracy

Attitude (deg) 0.050

Heading (deg) 0.050

Position (m) 2.000

Velocity (m/s) 0.500

Ok Close Apply

**Frame Control**

(Use Tools > Config)

User Frame      Primary GPS Measurement   
 IMU Frame      Auxiliary GPS Measurement   
 Use GAMS enabled

**GPS Receiver Configuration**

(Use Settings> Installation> GPS Receiver Configuration)

**Primary GPS Receiver**

**Gps Receiver Configuration**

Primary GPS Receiver    Secondary GPS Receiver

Primary GPS

GPS Output Rate: 1 Hz

Auto Configuration:  Enabled  Disabled

GPS 1 Port

Baud Rate: 9600

Parity:  None  Even  Odd

Data Bits:  7 Bits  8 Bits  9 Bits

Stop Bits:  1 Bit  2 Bits

Ok Close Apply

**Secondary GPS Receiver**

**Gps Receiver Configuration**

Primary GPS Receiver    Secondary GPS Receiver

Secondary GPS

GPS Output Rate: 1 Hz

Auto Configuration:  Enabled  Disabled

GPS 2 Port

Baud Rate: 9600

Parity:  None  Even  Odd

Data Bits:  7 Bits  8 Bits  9 Bits

Stop Bits:  1 Bit  2 Bits

Ok Close Apply

# FAIRWEATHER

## Multibeam Echosounder Calibration

Launch 1010

Vessel

4/17/2009 | 107 | Lake Washington, Seattle, Washington  
Date Dn Local Area

Rice, Beduhn, Forney, Marcum  
Calibrating Hydrographer(s)

Reson 8101 | Swing Arm-Hull Mount | not available  
MBES System MBES System Location Date of most recent EED/Factory Check

2701011 | 35737  
Sonar Serial Number Processing Unit Serial Number

Swing Arm | 3/20/2009  
Sonar Mounting Configuration Date of current offset measurement/verification

DGPS - Woodby Island | 4/15/2009  
Description of Positioning System Date of most recent positioning system calibration

### Acquisition Log

4/17/2009 | 107 | Lake Washington | 5-10kt, >1ft  
Date Dn Local Area Wx

| 10m-80m  
Bottom Type Approximate Water Depth

Marcum, Rice, Forney, Beduhn  
Personnel on board

Beacon: 302 Hz Whidbey, MBES lines 2009\_1071850\_1 through 2009\_1072047\_5, 24 lines collected  
Comments

TH\_1010\_107  
TrueHeave filename

SV Cast #1 filename	UTC Time	Lat	Lon	Depth	Ext. Depth
09107175_4616.5nv	0:00	47/39/01.97	122/16/17.32	51	

09107202.3nv	0:00	47/39/15.82	122/15/31.53	51	
--------------	------	-------------	--------------	----	--

09107210.0nv	0:00	47/39/08.84	122/14/06.18	15	20
--------------	------	-------------	--------------	----	----

view parallel to track, one line with induced roll (outerbeam) or same lines bounded slope (nadir)  
[same direction, different speed]

**NAV TIME LATENCY**

SV Cast #	XTF Line Filename	Heading	Speed (kts)	Remarks
1	2009_1071923_1	271	5.4	
1	2009_1071925_1	093	5.1	
1	2009_1071927_1	272	5.0	
1	2009_1071929_1	091	5.0	
1	2009_1071914_1	272	2.9	
1	2009_1071917_1	090	2.7	
1	2009_1071931_1	272	2.5	

**PITCH** view parallel to track, same line (at nadir) [opposite direction, same speed]

SV Cast #	XTF Line Filename	Heading	Speed (kts)	Remarks
1	2009_1071850_1	272	4	
1	2009_1071910_1	92	4	
1	2009_1071905_1	93	4	
1	2009_1071907_1	271	4	
1	2009_1071903_1	270	4	

**HEADING/YAW** view parallel to track, offset lines (outerbeams) [opposite direction, same speed]

SV Cast #	XTF Line Filename	Heading	Speed (kts)	Remarks
1	2009_1071945_4	272	4	N
1	2009_1071938_4	272	4	N
1	2009_1071935_4	94	4	N
1	2009_1071941_4	93	4	N
1	2009_1071955_2	092	4	S
1	2009_1071959_2	272	4	S
1	2009_1071949_2	092	4	S
1	2009_1071952_2	272	4	S

**ROLL** view across track, same line [opposite direction, same speed]

SV Cast #	XTF Line Filename	Heading	Speed (kts)	Remarks
2	2009_1072043_5	04	3.8	
2	2009_1072039_5	183	3.5	
2	2009_1072047_5	184	3.5	
2	2009_1072035_5	03	3.9	



**Processing Log**

4/18/2009 | 108 | Welton  
 Date Dn Personnel

- Data converted --> HDCS\_Data in CARIS
- TrueHeave applied \_\_\_\_\_
- SVP applied \_\_\_\_\_
- Tide applied \_\_\_\_\_
- Zone file na \_\_\_\_\_
- Lines merged
- Data cleaned to remove gross fliers

**Compute correctors in this order**

1. Precise Timing      2. Pitch bias      3. Heading bias      4. Roll bias

Do not enter/apply correctors until all evaluations are complete and analyzed.

**PATCH TEST RESULTS/CORRECTORS**

Evaluators	Latency (sec)	Pitch (deg)	Roll (deg)	Yaw (deg)	
FOO Ringel	-0.05	0.20	1.50	0.50	
B. Welton	0.02	-0.35	1.50	0.35	
G. Rice	0.01	0.43	1.48	0.28	
N.Morgan	0.06		1.48		
A. Raymond	0.02	0.00	1.46	0.20	
CST Morgan	0.00	-0.40	1.48	0.60	
<b>Averages</b>	0.01	-0.02	1.48	0.39	
<b>Standard Deviation</b>	0.04	0.36	0.04	0.16	0.08
<b>FINAL VALUES</b>	0.00	-0.02	1.48	0.39	

Final Values based on \_\_\_\_\_ averages with outliers removed

Resulting HVF File Name FA\_1010\_Reson8101\_2009.hvf

**Actual values used**

MRU Align StdDev gyro 0.16 Value from standard deviation of Heading offset values      MRU Align StdDev 0.075 gyro

MRU Align StdDev Roll/Pitch 0.19 Value from averaged standard deviations of pitch and roll offset values      MRU Align StdDev 0.025 Roll/Pitch

**NARRATIVE**

Lines from Dn108 (2009\_1081822\_11 through 2009\_1082211\_2) were also utilized to assess patch test values. Dn108 did not have True Heave applied as the Pos file was not logged, therefore a full patch write-up was not conducted.

Removed N. Morgan pitch (-1.6 deg) and yaw (1.62) values from the averages as outliers.

Initial MRU values were too high, TPU values reassessed with outliers removed.

- HVF Hydrographic Vessel File created or updated with current offsets

Name: CST/FOO/Welton      Date: 04/24/09

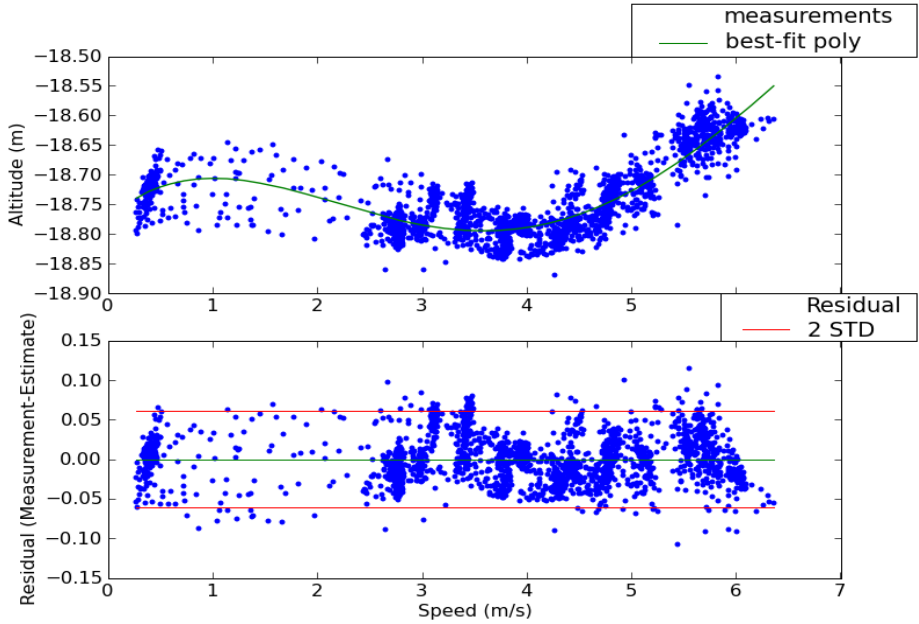
# Ellipsoid Referenced Dynamic Draft

Launch 1010

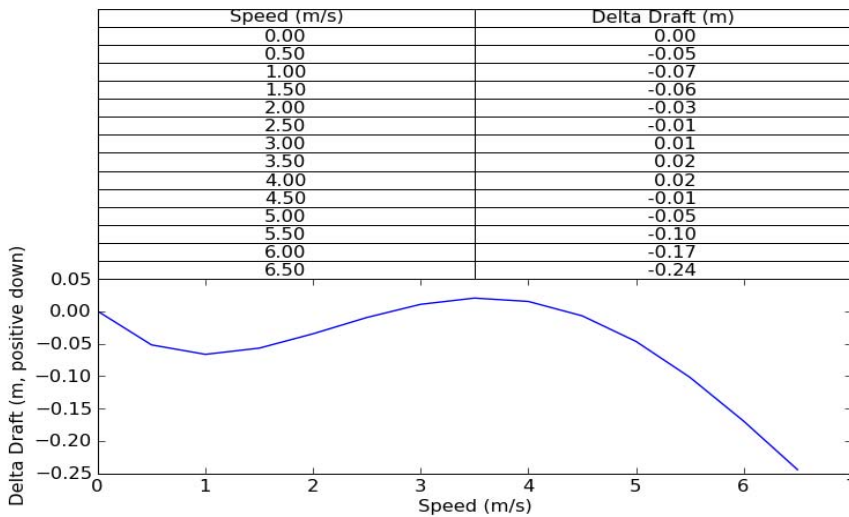
4/17/2009	107	Lake Washington	Rice
Date	DN	Local Area	Processor

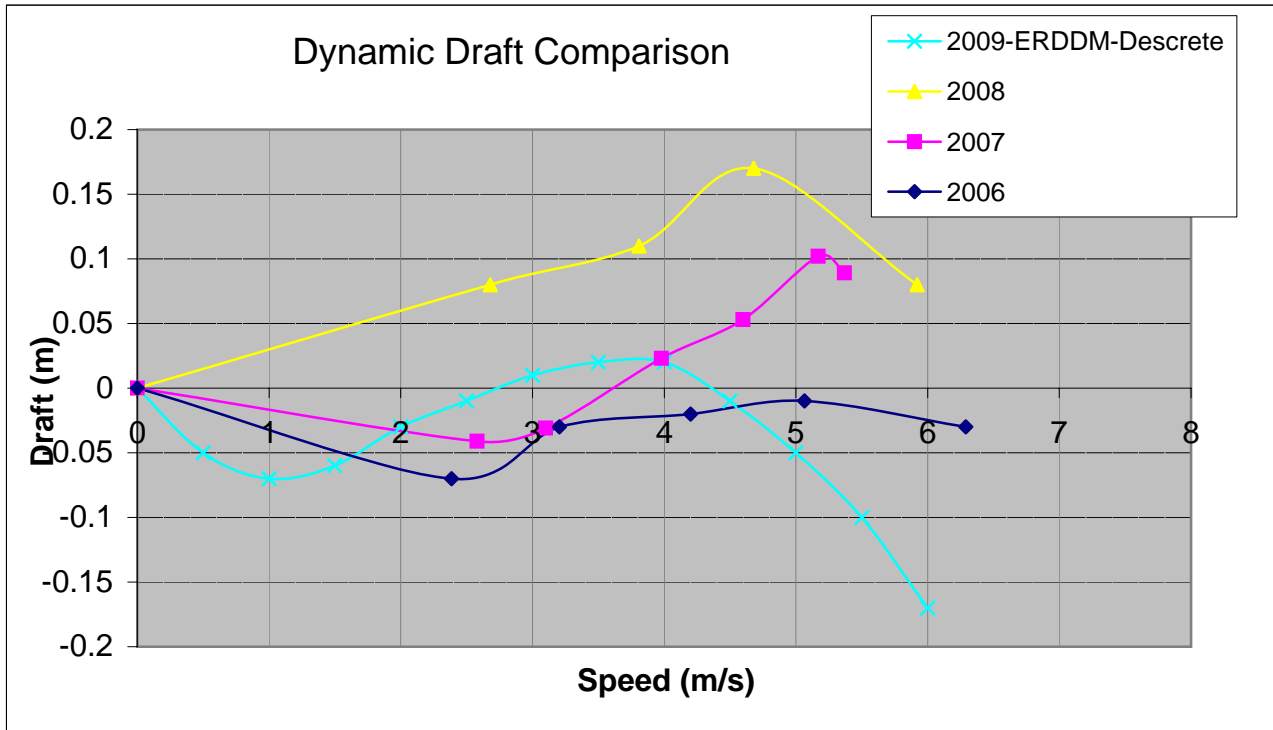
SEAI	TH_1010_107.000.002	1018_ERDDM.txt
Primary Station	POSPac File	SBET File

proc_erddm.py, v0.12	4
Processing Method	Coefficients



$$1.24e-003 * X^3 + -2.15e-002 * X^2 + 1.05e-001 * X$$





#### 2009 HVF Values

##### 2009-ERDDM-Descrete

speed (m/s)	draft (m)
0	0
0.5	-0.05
1	-0.07
1.5	-0.06
2	-0.03
2.5	-0.01
3	0.01
3.5	0.02
4	0.02
4.5	-0.01
5	-0.05
5.5	-0.1
6	-0.17

##### 2008

speed (m/s)	draft (m)
0	0
2.68	0.08
3.81	0.11
4.68	0.17
5.92	0.08

##### 2007

speed (m/s)	draft
0	0
2.58	-0.041
3.1	-0.031
3.98	0.023
4.6	0.053
5.17	0.102
5.37	0.089

##### 2006

speed (m/s)	draft
0	0
2.385	-0.07
3.205	-0.03
4.2	-0.02
5.065	-0.01
6.29	-0.03

# Reference Surface Acquisition Log

Launch 1010

Vessel

4/18/2009	108	Shilshole Reference Surface	<1ft, <5kts
Date	Dn	Local Area	Wx

Andrews, Rice, Beduhn, Raymond

Personnel

Comments

09108172.7nv	1727	47/40/27.300	122/25/35.70	34	44.2
SV Cast #1 filename	UTC Time	Lat	Lon	Depth	Ext. Depth

09108211.0nv	2110	47/40/30.96	122/25/31.12	37.1	48.2
SV Cast #2 filename	UTC Time	Lat	Lon	Depth	Ext. Depth

SV Cast #	XTF Line Filename	Heading	Line Type	Remarks
2110	2009_1082123_3	240	ref	east-west
	2009_1082126_7	061	ref	east-west
	2009_1082128_8	240	ref	east-west
	2009_1082130_5	061	ref	east-west
	2009_1082132_4	240	ref	east-west
	2009_1082135_9	061	ref	east-west
	2009_1082137_9		ref	north-south
	2009_1082139_10		ref	north-south
	2009_1082142_11		ref	north-south
	2009_1082146_12		ref	north_south
	2009_1082149_13	150	ref	north-south
	2009_1082151_1	345	ref	north-south
	2153	155	ref	north-south
	2155	345	ref	north-south
	2158	161	ref	north-south
	2009_1082207_1	132	Heading	
	2009_1082208_1	312	Heading	
	2009_1082210_2	132	Heading	
	2009_1082211_2	312	Heading	

1018 Offsets and Measurements - Summary

Measurement aka Coord. Sys.	IMU to RP* Caris	8101 to RP* Caris	IMU to 8101 SWATH1 x,y,z & MRU to Trans Caris	Port Ant to 8101 Nav to Trans x,y,z Caris	RP* to Waterline Caris	Port Ant to Stbd Ant Scalar Distance 1.834	IMU to Port Ant Caris Pos/Mv	IMU to Heave Caris Pos/Mv
x	0.000	0.282	0.282	1.181	n/a		-0.898 -1.101	0.015 -1.114
y	0.000	-0.145	-0.145	0.955	n/a		-1.101 -0.898	-1.114 0.015
z	0.000	0.548	0.548	3.717	-0.333		-3.161 -3.161	-0.336 -0.336

\*IMU is Reference Point

Vessel Offsets for 1018\_8101 are derived from the [Horizontal](#), [Vertical](#) & [XYZ](#) worksheets in this spreadsheet.

2008 Measured Value

2009 Measured Value

Values in the POSMV remained as entered in 2008.

Calculations

Coord. Sys.	8101 to RP*	IMU to 8101	Port Ant to 8101	RP to Waterline	Port Ant to Stbd Ant	IMU to Port Ant	IMU to Heave
<u>Theodolite</u>							
IMU (m)	x 3.54587 y -0.01516 z -0.85883	x 3.54587 y -0.01516 z -0.85883	IMU (m) x 3.54587 y -0.01516 z -0.85883	IMU (m) x 3.546 y -0.015 z -0.859	Port Ant (m) x 2.445 y -0.913 z 2.309	IMU (m) x 3.546 y -0.015 z -0.859	IMU (m) y -0.015 z -0.859
BM H	x 3.30204 y 0.43081 z -1.0485	Port Ant (m) x 2.445 y -0.913 z 2.309	BM C x 0.000 y 0.000 z 0.000	Stbd Ant (m) x 2.445 y 0.921 z 2.280	Port Ant(m) x 2.445 y -0.913 z 2.302	Heave Pt (m) (centerline) y 0.000	BM C to Waterline (m) measured scalar dist -0.523
IMU to BM H	x -0.244 y 0.446 z -0.190	IMU to Port Antenna x -1.101 y -0.898 z 3.168	BM C to IMU x n/a y n/a z -0.859	BM C to Waterline (m) z -0.526		BM C x&y are n/a z 0.000	BM C to Waterline (m) (Heave Pt) z -0.523
BM H to Phase Ctr measured (cm)	x 9.867 y -16.372 z -35.876	IMU to Phase Ctr x -0.145 y 0.282 z -0.548				IMU to Hv x -1.114 <a href="#">See IMU to Heave tab.</a>	
BM H to Phase Ctr (m)	x 0.099 y -0.164 z -0.359						
Coord. Sys. <u>Theodolite</u>	IMU to 8101	IMU to 8101	Port Ant to 8101	RP to Waterline	Port Ant to Stbd Ant	IMU to Port Ant	IMU to Heave
	IMU to Phase Ctr x -0.145 y 0.282 z -0.548	IMU to Phase Ctr x -0.145 y 0.282 z -0.548	Port Ant to Phase Ctr x 0.955 y 1.181 z -3.717	RP to Waterline x n/a y n/a z 0.333	Port Ant to Stbd Ant Scalar Distance 1.8343	IMU to Port Ant x -1.101 y -0.898 z 3.161	IMU to Heave x -1.114 y 0.015 z 0.336
Coord. Sys. <u>CARIS</u>	IMU to 8101 x 0.282 y -0.145 z 0.548	IMU to 8101 x 0.282 y -0.145 z 0.548	Port Ant to 8101 x 1.181 y 0.955 z 3.717	RP to Waterline x n/a y n/a z -0.333		Coord. Sys. <u>Pos/Mv</u> x -1.101 y -0.898 z -3.161	Coord. Sys. <u>Pos/Mv</u> x -1.114 y 0.015 z -0.336 <a href="#">See IMU to Heave tab.</a>

Measurement aka Coord. Sys.	IMU to 8125 <i>SWATH1 x,y,z &amp; MRU to Trans</i>	Port Ant to 8125 <i>Nav to Trans x,y,z</i>	RP* to Waterline	Port Ant to Stbd Ant	IMU to Port Ant	IMU to Heave		
	Caris	Caris	Caris		Caris Pos/Mv	Caris Pos/Mv		
x	-0.396	0.502	n/a	Scaler Distance 1.834	-0.898	-1.101	0.015	-1.114
y	0.982	2.082	n/a		-1.101	-0.898	-1.114	0.015
z	0.751	3.919	-0.333		-3.161	-3.161	-0.336	-0.336

Vessel Offsets [Horizontal](#), [Vertical](#) & [XYZ](#) worksheets in this spreadsheet.

2009 Measured Value

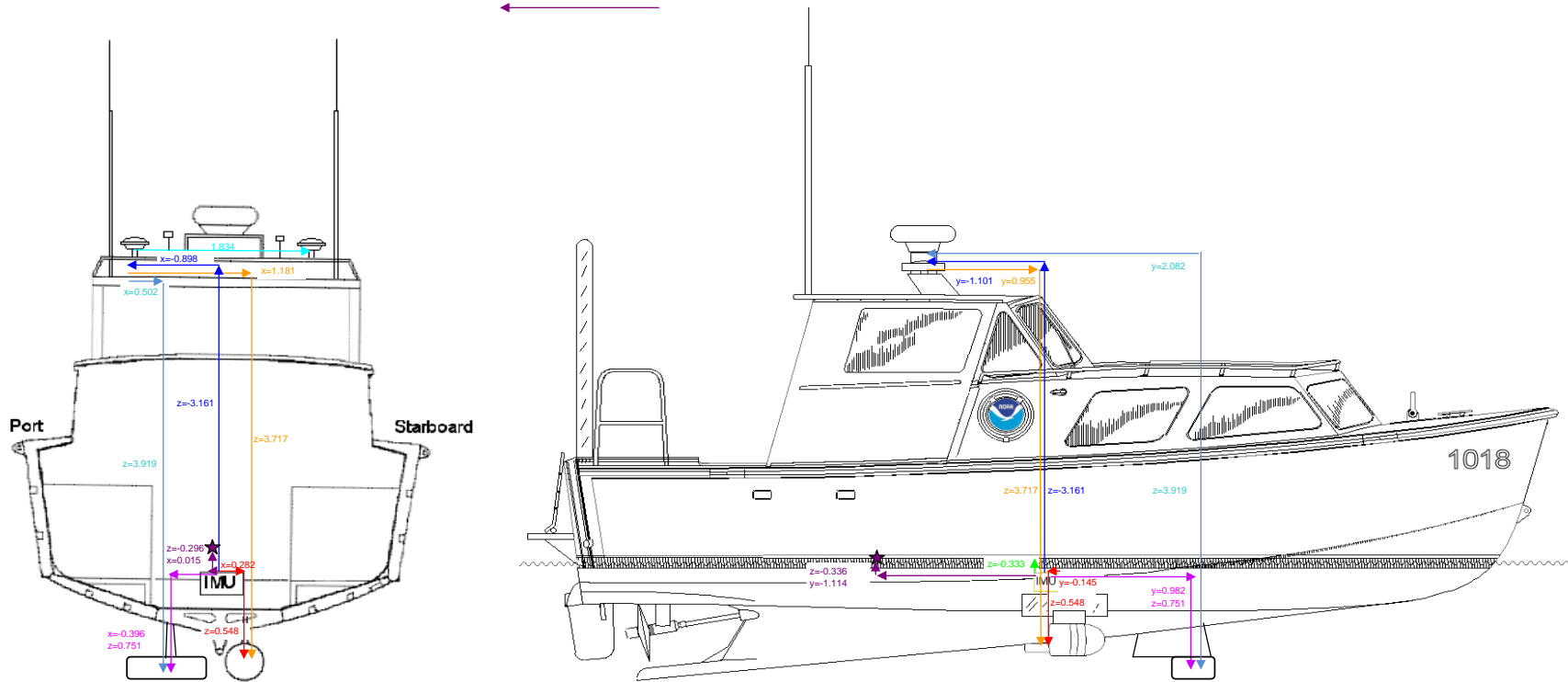
### Calculations

Coord. Sys.	IMU to 8125	Port Ant to 8125
<u>Theodolite</u>		
IMU (m)	x 3.54587 y -0.01516 z -0.85883	IMU (m) x 3.54587 y -0.01516 z -0.85883
BM H	x 3.30204 y 0.43081 z -1.0485	Port Ant (m) x 2.445 y -0.913 z 2.309
IMU to BM H	x -0.244 y 0.446 z -0.190	IMU to Port Antenna x -1.101 y -0.898 z 3.168
BM H to Phase Ctr measured (cm)	x 122.533 y -84.216 z -56.133	IMU to Phase Ctr x 0.982 y -0.396 z -0.751
BM H to Phase Ctr (m)	x 1.225 y -0.842 z -0.561	
Coord. Sys. <u>Theodolite</u>	IMU to Phase Ctr x 0.982 y -0.396 z -0.751	Port Ant to 8125 x 2.082 y 0.502 z -3.919
Coord. Sys. <u>CARIS</u>	x -0.396 y 0.982 z 0.751	Coord. Sys. <u>CARIS</u> x 0.502 y 2.082 z 3.919

## Description of Offsets for Launch 1018

All Values Shown are in CARIS Coordinates

The Ship Reference Frame (SRF) for Launch 1018 was based from benchmark (BM) C as the 0 point. Physical locations were measured with x,y,z offsets from this point. These locations were used to calculate offsets of items with respect to each other, as described for each offset.



IMU to 8101		
x	y	z
0.282	-0.145	0.548

IMU to 8125		
x	y	z
-0.396	0.982	0.751

The physical positions of the IMU and the phase center of the 8101 with respect to the Ship Reference Frame were measured by NOAA personnel. These physical measurements were used to calculate the xyz offsets from the IMU to BM H. Measurements from BM H to the Phase Center of the 8101 were collected by NOAA personnel while the boat was secured on the pier and thought to be as level as possible. The measured offsets from BM H to the phase center were then added to the offset from the IMU to BM H. The result is the offset from the IMU to the phase center of the transducer. The values in the X and Y fields are transposed and the inverse of the Z value is used to give the offsets in CARIS coordinates.

Port Ant to 8101		
x	y	z
1.181	0.955	3.717

Port Ant to 8125		
x	y	z
0.502	2.082	3.919

NOAA personnel calculated the distance between the port antenna and the phase center of the port antenna subtracting the IMU to Port Antenna value from the IMU to Phase Center value.

RP to Waterline		
x	y	z
N/A	N/A	-0.333

The average vertical distance from BM A and B to the waterline was measured by FAIRWEATHER personnel using a steel tape and bubble level. These values were used to calculate the BM C to the waterline value. With the knowledge of the BM C height above the IMU, the waterline height above the IMU could be calculated. On launch 1018, the IMU is used as the reference point.

Port Ant to Stbd Ant
Scalar Distance
1.834

The location of the phase center of the port and starboard POS/MV antennas were measured by NOAA personnel with respect to the SRF. The scalar distance between the phase centers was then calculated.

IMU to Port Antenna		
x	y	z
-0.898	-1.101	-3.161

The location of the IMU and the location of the port antenna were measured by NOAA personnel with respect to the Ship Reference Frame (SRF). The xyz offsets from the IMU to the port antenna could be calculated from these physical locations.

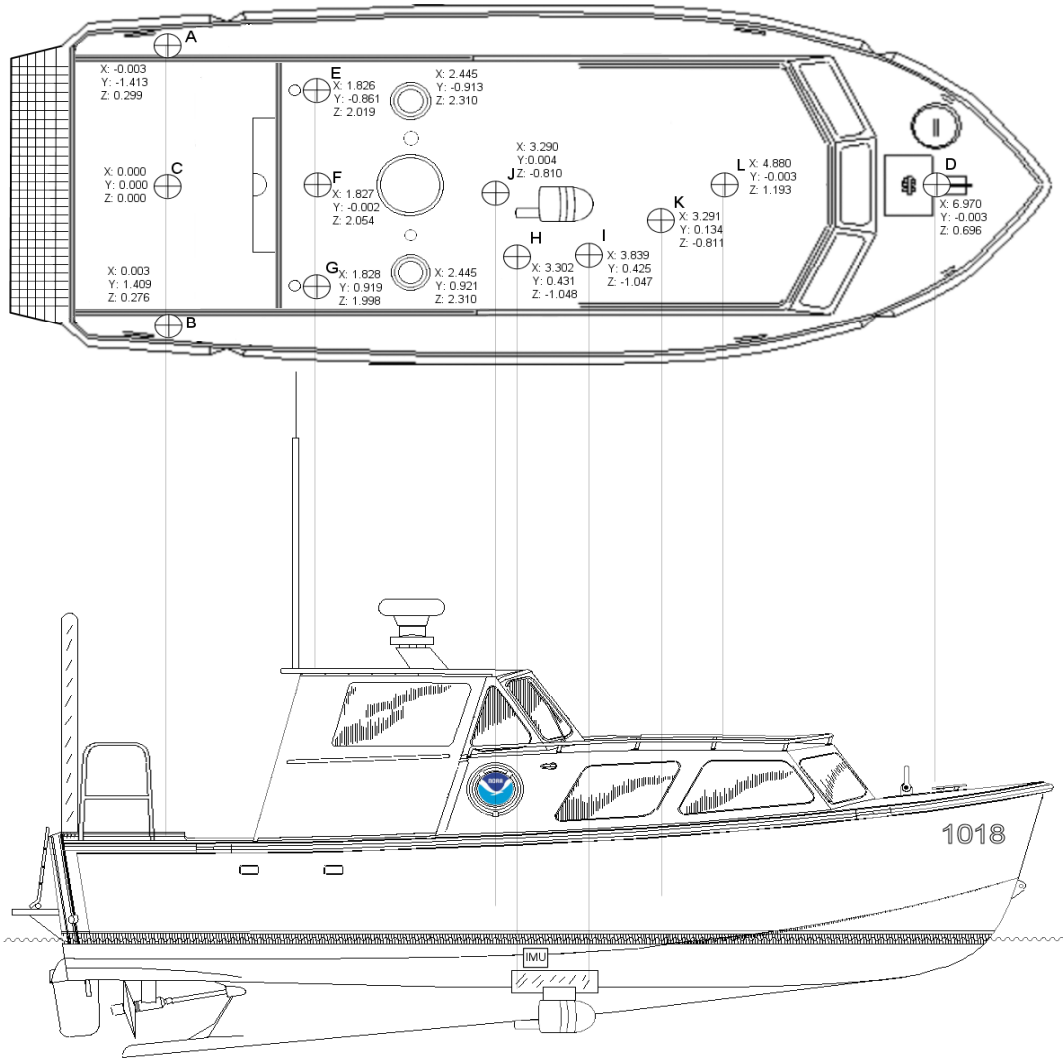
IMU to Heave		
x	y	z
0.015	-1.114	-0.336

The heave point was positioned differently on each of the axes. The distance for the longitudinal axis was determined as described in the "IMU to Heave" tab in this workbook. The athwart ships axis was the vessel centerline. Lastly, the waterline was used as the height of the heave point, which was calculated earlier in 'RP to Waterline'.

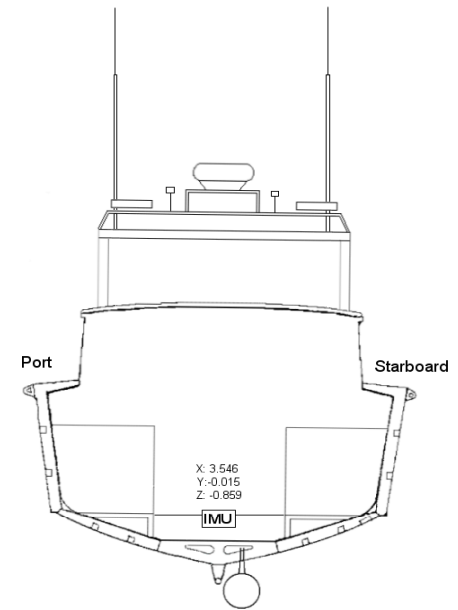


# 1018 Vessel Diagram

All Values Shown are in Theodolite Coordinates



Note: Both antenna have been replaced for the POS V4. While their x-y values are not thought to have changed, the z-value has been remeasured.



IMU to 8125		Port Ant to 8125	
SWATH1 x,y,z & MRU to Trans		Nav to Trans x,y,z	
Caris		Caris	
x	-0.415	x	0.483
y	0.794	y	1.895
z	0.712	z	3.881

Values for 8125 Phase center adjusted, newer manual had different location.  
 Adjustment applied to data after June 2009 (Dn155),  
 P183, P357, P158, O351, and S-O927.

IMU to 8125		Port Ant to 8125	
IMU (m)	x 3.54587	IMU (m)	x 3.54587
	y -0.01516		y -0.01516
	z -0.85883		z -0.85883
BM H	x 3.30204	Port Ant (m)	x 2.445
	y 0.43081		y -0.913
	z -1.0485		z 2.309
IMU to BM H	x -0.244	IMU to Port Antenna	x -1.101
	y 0.446		y -0.898
	z -0.190		z 3.168
BM H to Phase Ctr measured (cm)	x 103.793	IMU to Phase Ctr	x 0.794
	y -86.141		y -0.415
	z -52.256		z -0.712
BM H to Phase Ctr (m)	x 1.038		
	y -0.861		
	z -0.523		

IMU to 8125		Port Ant to 8125	
IMU to Phase Ctr	x 0.794		x 1.895
	y -0.415		y 0.483
	z -0.712		z -3.881
Coord. Sys. <b>CARIS</b>		Coord. Sys. <b>CARIS</b>	
	x -0.415		x 0.483
	y 0.794		y 1.895
	z 0.712		z 3.881

### Waterline Measurements

Measuring Party: Rice, Argento, Campbell, Beduhn  
 Waterline measurements should be negative!

1018		
	Benchmark A to Waterline	Benchmark B to Waterline
Measure 1	-80.8	-81.0
Measure 2	-81.3	-82.1
Measure 3	-81.1	-81.9
Avg (cm)	-81.07	-81.67
Avg (m)	-0.8107	-0.8167
Stdev	0.00252	0.00586
BM Z-value (m)	0.29933	0.27567
BM C to WL (m)	-0.511	-0.541
Individual measurement	-0.50867	-0.53433
	-0.51367	-0.54533
StDev for TPU xls (of 6 #s)	0.016742	-0.54333

Measuring Party: Raymond, Welton

1018		
	Benchmark A to Waterline	Benchmark B to Waterline
Measure 1	-82.4	-82.2
Measure 2	-82.3	-82.2
Measure 3	-82.0	-81.1
Avg (cm)	-82.23	-81.83
Avg (m)	-0.8223	-0.8183
Stdev	0.00208	0.00635
BM Z-value (m)	0.29933	0.27567
BM C to WL (m)	-0.523	-0.543
Individual measurement	-0.52467	-0.54633
	-0.52367	-0.54633
StDev for TPU xls (of 6 #s)	0.011572	-0.53533

### Fill in Yellow squares only!

Date: 4/7/2009  
 Fuel Level: 0.75  
 Draft Tube:

Port-to-Stbd Z-difference  
 Theoretical Actual Error  
 0.0237 -0.0060 -0.0297

BM C to WL Average (m)  
 -0.526 (Add this value to 1018\_Offsets & Measurements\_200X.xls)

utilized in Offsets and Measurements and TPU spreadsheet

Date: 4/16/2009  
 Fuel Level: half full  
 Draft Tube: na

Port-to-Stbd Z-difference  
 Theoretical Actual Error  
 0.0237 0.0040 -0.0197

BM C to WL Average (m)  
 -0.533 (or add this value to 1018\_Offsets & Measurements\_2008)

This spreadsheet is designed to compute the z-values of the phase centers of the new POS M/V antenna.

**All offsets are in the Theodolite Coordinate System**

BM E    x 1.825761  
           y -0.861405  
           z 2.018667

BM F    x 1.826865  
           y -0.002043  
           z 2.054333

BM G    x 1.828354  
           y 0.918931  
           z 1.998333

Port Ant    x 2.445325  
               y -0.913449  
               z Unknown

Stbd Ant    x 2.444676  
               y 0.920569  
               z Unknown

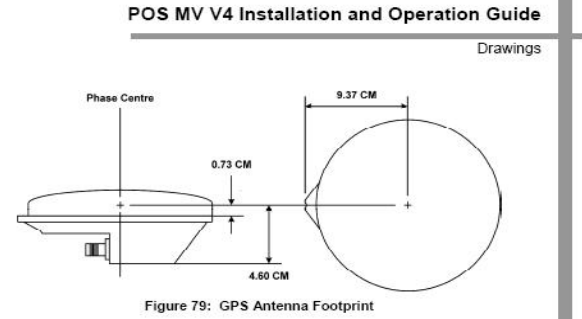


Figure 79: GPS Antenna Footprint

**Measuring Party (fill in yellow spaces only):**  
 Rice, Argento, Campbell, Beduhn

**Date:**  
 4/7/2009

<b>Serial #- Port</b>	<b>Serial #- Stbd</b>
60145158	60130644

**Distances**

Port Ant to BM 'E'	0.652	0.652	0.653	0.665083
Port Ant to BM 'F'	1.109	1.11	1.111	1.12275
Port Ant to BM 'G'	1.941	1.945	1.943	1.95575

Stbd Ant to BM 'E'	1.884	1.882	1.889	1.89775
Stbd Ant to BM 'F'	1.111	1.112	1.113	1.12475
Stbd Ant to BM 'G'	0.648	0.647	0.647	0.660083

Antenna Post	Diameter	Radius
	0.0255	0.01275

**z-Values**

Ant. Base	Phase Center
2.254818	2.300818
2.272081	2.318081
2.292759	2.338759
2.263449	2.309449
	AVERAGE
	0.019 STDEV
2.225956	2.271956
2.233664	2.279664
2.234669	2.280669
2.234166	2.280166
	AVERAGE
	0.005 STDEV

The distances from the antenna post to each benchmark was measured three times and averaged. The post offset to phase center (radius) was then added.

The distance is 0.046m (4.60cm) from the bottom of the antenna to the Phase center, obtained from the POSM/V v4 guide, see image above.

# Offsets from Aft Benchmark to Phase Center of Transducer

3/20/2009	79	launch 1018	Campbell, Argento, Rice, Beduhn
Date	DN	Vessel	Personnel

3102026

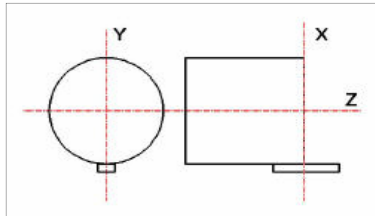
  
 Serial Number of Transducer

**Instructions:** The purpose of this measurement is to check for gross movement of the transducer. **Fill in yellow spaces only.**

While the boat is in the cradle, gently lower the transducer and lock it in place. Using a metric tape measure, plumb bob and carpenter's level, measure the horizontal and vertical offsets from the aft benchmark (BM H) to the phase center of the transducer. The phase center is measured at the forward edge of the black insulating layer, as shown in the photos. If you have trouble locating the center, borrow a compass from the navigation department.



Notwithstanding a major accident, BM H will be outboard, aft and higher than the phase center; as such, enter all offsets as positive numbers (in cm) and the proper signs will be applied.



Once offsets have been measured, apply a digital level to the IMU to determine any pitch or roll bias in the orientation of the launch. For the purposes of this spreadsheet, a positive angle (measured in degrees) will imply the bow is higher than the stern and the port side is higher than the starboard side.

All measurements should be done in triplicate to aid in the calculation of the uncertainty (needed in the HVF). The *IMU to Phase Center* values will be calculated automatically.

Offset Measurements (positive cm):				Average
Bow-Stern	8.7	8.7	8.8	8.7
Port-Stbd	15.9	15.9	15.8	15.9
Up-Down	35.5	35.4	36.0	35.6

Angle Bias (deg):	
Bow Up	
Port Up	

The measuring crew should insure there will be no yaw bias.

Std Dev:	
Bow-Stern	0.06
Port-Stbd	0.06
Up-Down	0.32

BM H to Phase Center	
(Theodolite Coordinate System)	
x	8.733 cm
y	-15.867 cm
z	-35.633 cm

Measured by NOAA Personnel inserted into Offset Worksheet, if to be used in IMU to 8101 calculation

IMU to Phase Center (8101)	
(CARIS Coordinate System)	
x	0.287 m
y	-0.156 m
z	0.546 m

Calculated Value for check purposes  
 \* [see Math Explanation tab](#)

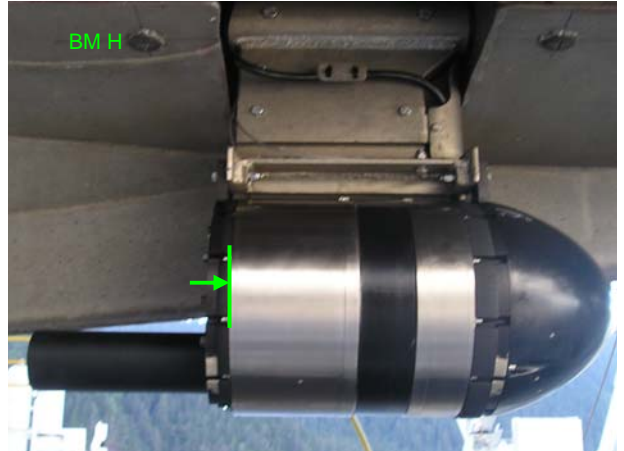
These 2009 values were not used for the hvf offsets due to the angle bias not being entered. The 2008 values were used instead and the 2009 values were used as a check that the unit had not been displaced.

# Offsets from Aft Benchmark to Phase Center of Transducer

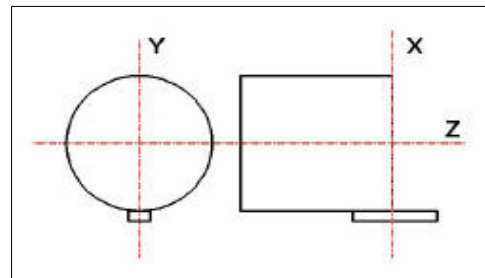
4/1/2008	92	1018	Andrews, Breen, Campbell, Rice
Date	DN	Vessel	Personnel

**Instructions:** The purpose of this measurement is to check for gross movement of the transducer.

While the boat is in the cradle, gently lower the transducer and lock it in place. Using a metric tape measure, plumb bob and carpenter's level, measure the horizontal and vertical offsets from the aft benchmark (BM H) to the phase center of the transducer. The phase center is measured at the forward edge of the black insulating layer, as shown in the photos. If you have trouble locating the center, borrow a compass from the navigation department.



Notwithstanding a major accident, BM H will be outboard, aft and higher than the phase center; as such, enter all offsets as positive numbers (in cm) and the proper signs will be applied.



Once offsets have been measured, apply a digital level to the IMU to determine any pitch or roll bias in the orientation of the launch. For the purposes of this spreadsheet, a positive angle (measured in degrees) will imply the bow is higher than the stern and the port side is higher than the starboard side.

All measurements should be done in triplicate to aid in the calculation of the uncertainty (needed in the HVF). The *IMU to Phase Center* values will be calculated automatically.

Offset Measurements (positive cm):				Average
Bow-Stern	9.6	10.0	10.0	9.9
Port-Stbd	14.3	14.6	14.9	14.6
Up-Down	37.0	36.5	36.4	36.6

Angle Bias (deg):	
Bow Up	0.0
Port Up	-2.8

The measuring crew should insure there will be no yaw bias.

BM H to Phase Center	
(Theodolite Coordinate System)	
x	<u>9.867</u> cm
y	<u>-16.372</u> cm
z	<u>-35.876</u> cm

IMU to Phase Center (8101)	
(CARIS Coordinate System)	
x	<u>0.282</u> m
y	<u>-0.145</u> m
z	<u>0.548</u> m

# Offsets from Aft Benchmark to Phase Center of Transducer

4/29/2009	119	launch 1018	Argento, Andrews, Foster, Nuckols
Date	DN	Vessel	Personnel

4400007
Serial Number of Transducer

**Instructions:** The purpose of this measurement is to check for gross movement of the transducer. **Fill in yellow spaces only.**

While the boat is in the cradle, connect the 8125 sled with the sonar head attached. Using a metric tape measure, plumb bob and carpenter's level, measure the horizontal and vertical offsets from the aft benchmark (BM H) to the phase center of the transducer. The phase center is measured at the center middle of the black insulating layer below the flat faced transducer, as shown in the photos. If you have trouble locating the center, borrow a compass from the navigation department.



Notwithstanding a major accident, BM H will be outboard, aft and higher than the phase center; as such, enter all offsets as positive numbers (in cm) and the proper signs will be applied.

Once offsets have been measured, apply a digital level to the IMU to determine any pitch or roll bias in the orientation of the launch. For the purposes of this spreadsheet, a positive angle (measured in degrees) will imply the bow is higher than the stern and the port side is higher than the starboard side.

All measurements should be done in triplicate to aid in the calculation of the uncertainty (needed in the HVF). The *IMU to Phase Center* values will be calculated automatically.

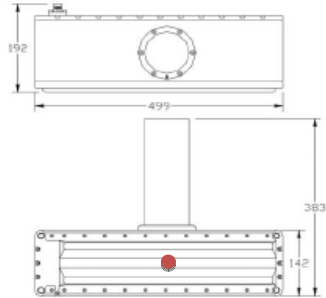


Figure 3 - Transducer array outline dimensions

Offset Measurements (positive cm):				Average
Bow-Stern	123.2	122.0	122.4	122.5
Port-Stbd	84.2	84.4	84.1	84.2
Up-Down	55.7	56.2	56.5	56.1

Angle Bias (deg):	
Bow Up	-0.5
Port Up	-2.0

Std Dev:	
Bow-Stern	0.61
Port-Stbd	0.15
Up-Down	0.40

The measuring crew should insure there will be no yaw bias.

BM H to Phase Center	
(Theodolite Coordinate System)	
x	122.533 cm
y	-84.233 cm
z	-56.133 cm

Measured by NOAA Personnel inserted into Offset Worksheet, if to be used in IMU to 8101 calculation

IMU to Phase Center (8125)	
(CARIS Coordinate System)	
x	-0.396 m
y	0.982 m
z	0.751 m

Calculated Value for check purposes  
[\\* see Math Explanation tab](#)

## Offsets from Aft Benchmark to Phase Center of Transducer

September 2009	155 +	launch 1018 8125	Andrews using April measured values and 8125 manual 4.01
Date	DN	Vessel	Personnel

4400007  
Serial Number of Transducer

**Instructions:** The purpose of this measurement is to check for gross movement of the transducer. **Fill in yellow spaces only.**

While the boat is in the cradle, connect the 8125 sled with the sonar head attached. Using a metric tape measure, plumb bob and carpenter's level, measure the horizontal and vertical offsets from the aft benchmark (BM H) to the phase center of the transducer. The phase center is measured at the center middle of the black insulating layer below the flat faced transducer, as shown in the photos. If you have trouble locating the center, borrow a compass from the navigation department.

Notwithstanding a major accident, BM H will be outboard, aft and higher than the phase center; as such, enter all offsets as positive numbers (in cm) and the proper signs will be applied.

Once offsets have been measured, apply a digital level to the IMU to determine any pitch or roll bias in the orientation of the launch. For the purposes of this spreadsheet, a positive angle (measured in degrees) will imply the bow is higher than the stern and the port side is higher than the starboard side.

All measurements should be done in triplicate to aid in the calculation of the uncertainty (needed in the HVF). The *IMU to Phase Center* values will be calculated automatically.

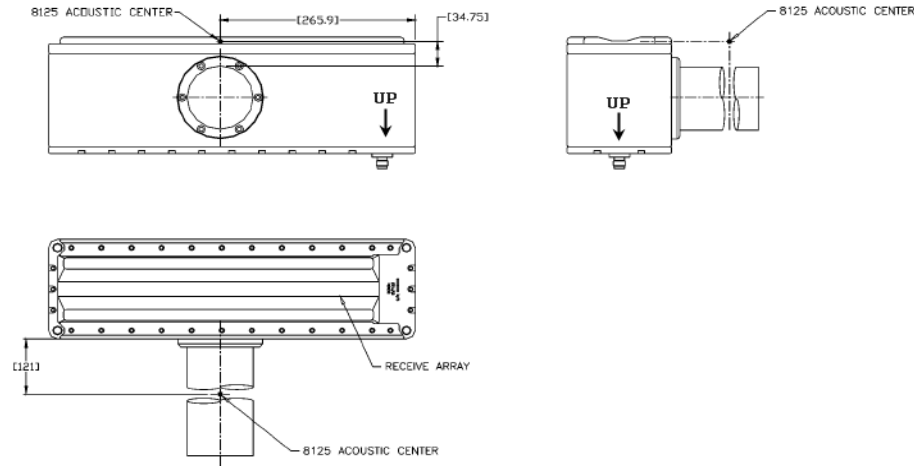


Figure 8: Sonar Head Acoustic Center

Offset Measurements (positive cm):	Average			
!!! Bow-Stern	104.0	102.8	103.2	103.3 !!!
Port-Stbd	84.2	84.4	84.1	84.2
Up-Down	55.7	56.2	56.5	56.1

Angle Bias (deg):	
Bow Up	-0.5
Port Up	-2.0

The measuring crew should insure there will be no yaw bias.

Std Dev:	
Bow-Stern	0.61
Port-Stbd	0.15
Up-Down	0.40

BM H to Phase Center	
(Theodolite Coordinate System)	
x	103.793 cm
y	-86.141 cm
z	-52.256 cm

Measured by NOAA Personnel inserted into Offset Worksheet, if to be used in IMU to 8125 calculation

IMU to Phase Center (8125)	
(CARIS Coordinate System)	
x	-0.415 m
y	0.794 m
z	0.712 m

Calculated Value for check purposes \* see [Math Explanation tab](#)

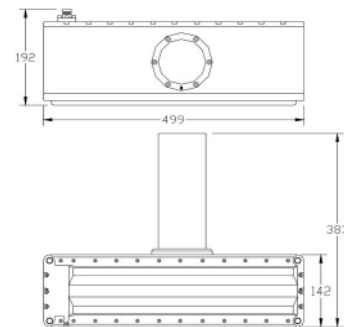
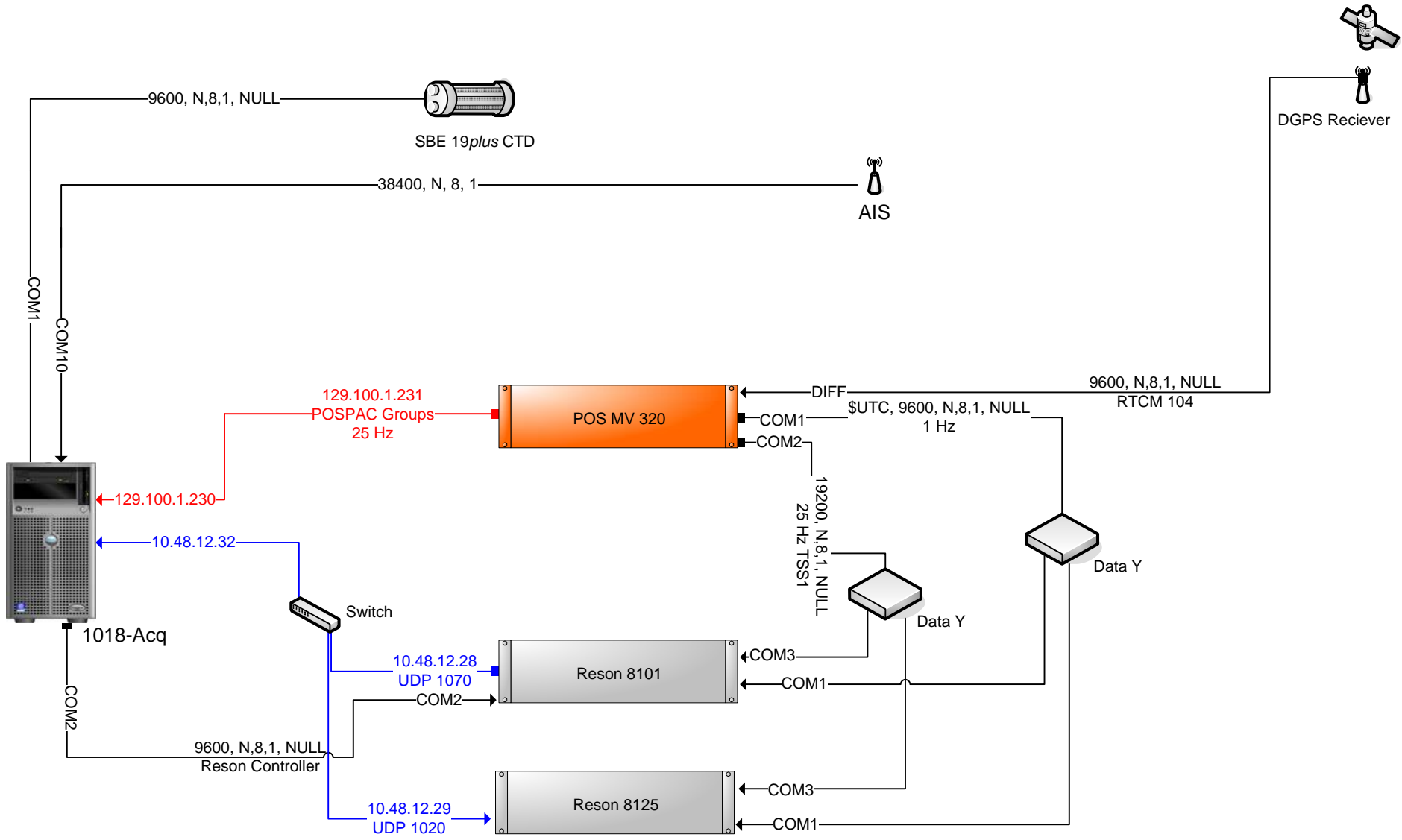


Figure 3: Sonar Head Dimensions

!!! The offsets were measured to the wrong phase center because an out-of-date manual was used. The bow-stern measurements were changed to the correct phase center by subtracting 12.1 cm (the distance from the receive array to the center) and 7.1 cm (half the width of the receive array) from the original measurement.



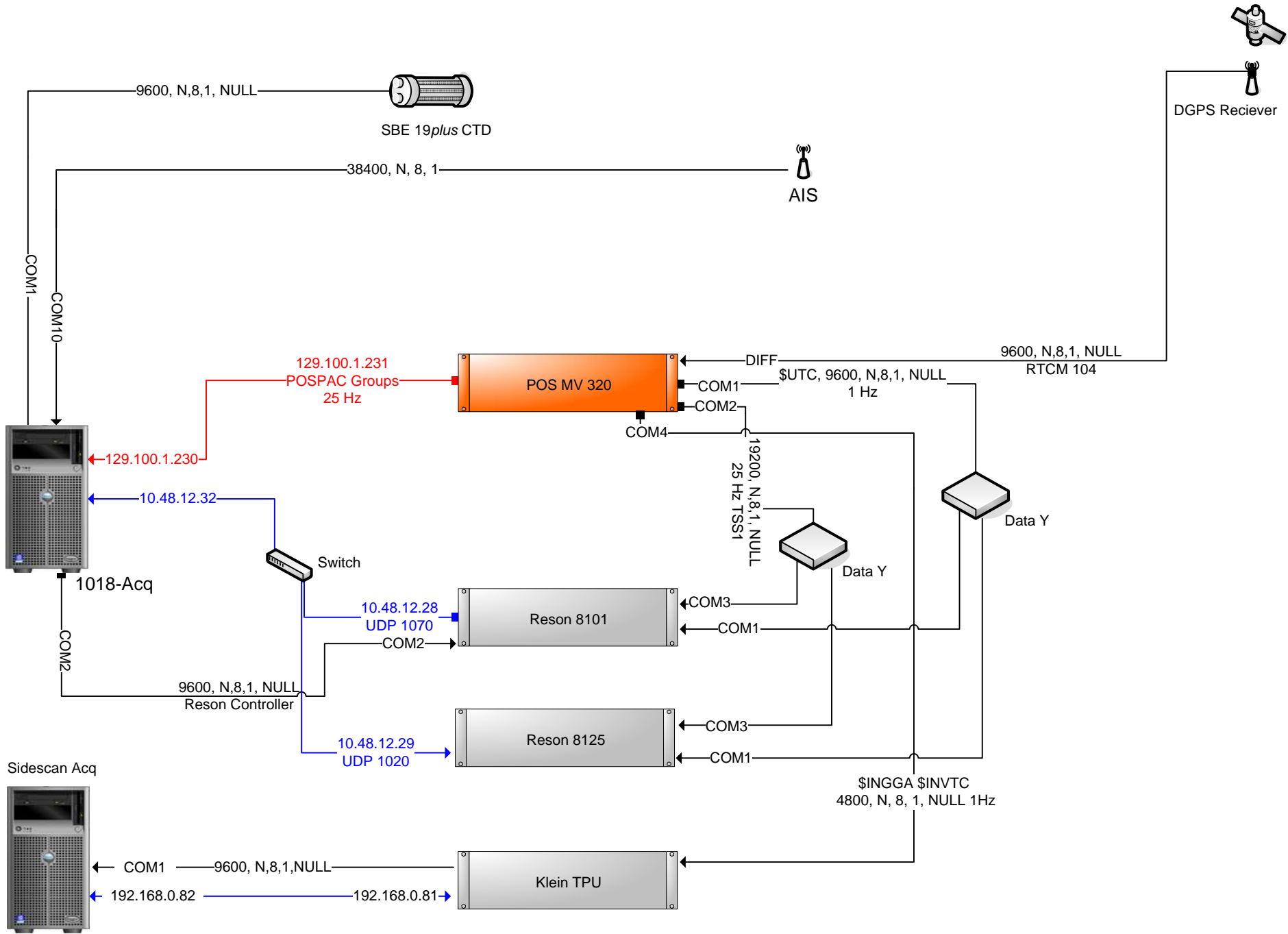


Key

- Serial
- Crossover
- Patch

**Launch 1018 Wire Diagram**

Rev 4.0	12 July 2009	LT Ringel
---------	--------------	-----------



Key

- Serial
- Crossover
- Patch

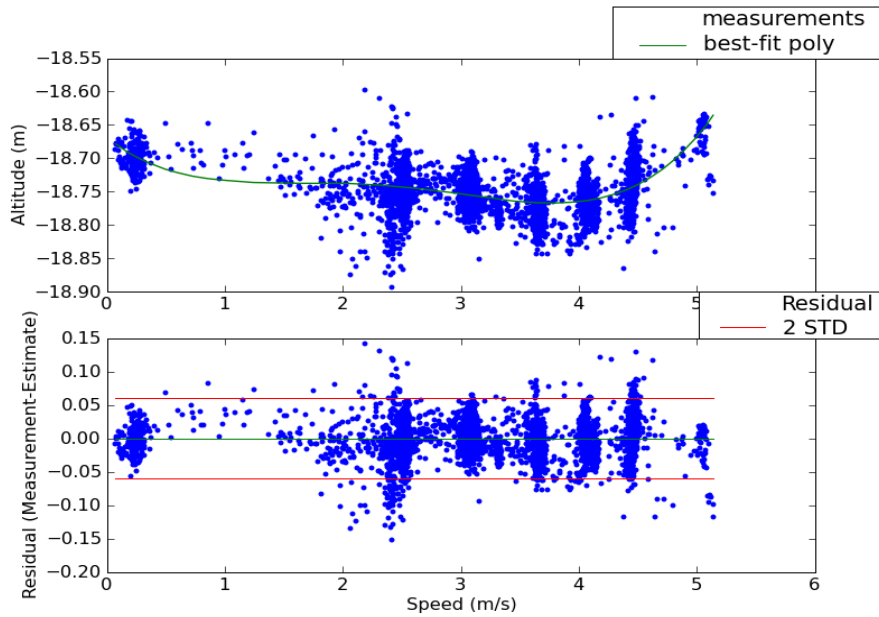
**Launch 1018 Wire Diagram  
with Sidescan**

Rev 1.0	12 July 2009	LT Ringel
---------	--------------	-----------

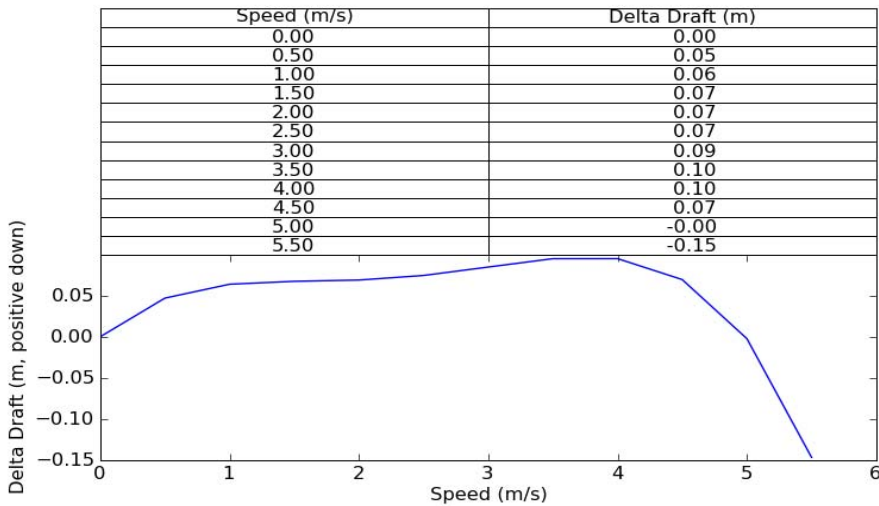
# Ellipsoid Referenced Dynamic Draft

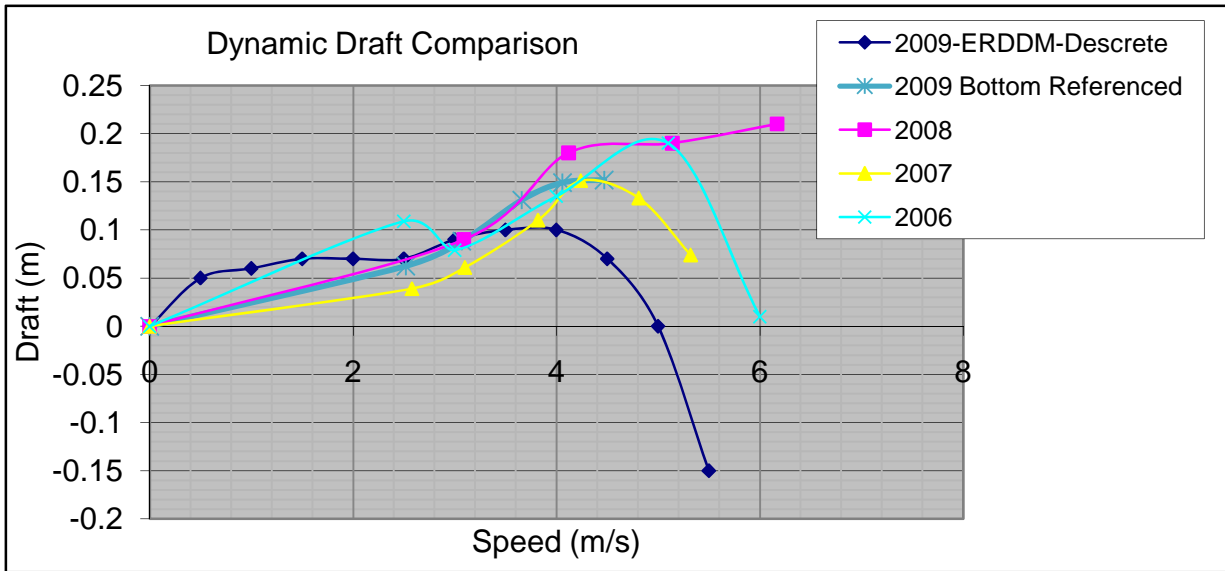
Launch 1018

4/16/2009	106 Lake Washington	Rice
Date	DN	Local Area Processor
SEAI	TH_1018_patch_test_dn105.000.002	1018_ERDDM.txt
Primary Station	POSPac File	SBET File
proc_erddm.py, v0.12	4	
Processing Method	Coefficients	



$$-3.59e-003 * X^3 + 3.31e-002 * X^2 + -1.04e-001 * X$$





**2009 HVF Values**

**2009-ERDDM-Descrete**

speed (m/s)	draft (m)
0	0
0.5	0.05
1	0.06
1.5	0.07
2	0.07
2.5	0.07
3	0.09
3.5	0.1
4	0.1
4.5	0.07
5	0
5.5	-0.15

**2009 Bottom Referenced**

speed (m/s)	draft (m)
0	0
2.52	0.062
3.07	0.088
3.66	0.131
4.06	0.149
4.47	0.152

**2008**

speed (m/s)	draft (m)
0	0
3.09	0.09
4.12	0.18
5.14	0.19
6.17	0.21

**2007**

speed (m/s)	draft (m)
0	0
2.58	0.039
3.1	0.061
3.82	0.11
4.24	0.151
4.81	0.133
5.32	0.074

**2006**

speed (m/s)	draft (m)
0	0
2.5	0.109
3	0.079
4	0.135
5.1	0.19
6	0.01

# NOAA POS/MV Calibration Report

**Fill out all fields!** See previous years as an example.

**Yellow areas require screen grabs!**

Ship: FAIRWEATHER

Vessel: 1018

Date: 4/15/2009

Dn: 104

Personnel: Andrews, Welton, Forney, Shetler

PCS Serial # 2560

IMU Serial # 007

IP Address: 129.100.1.231

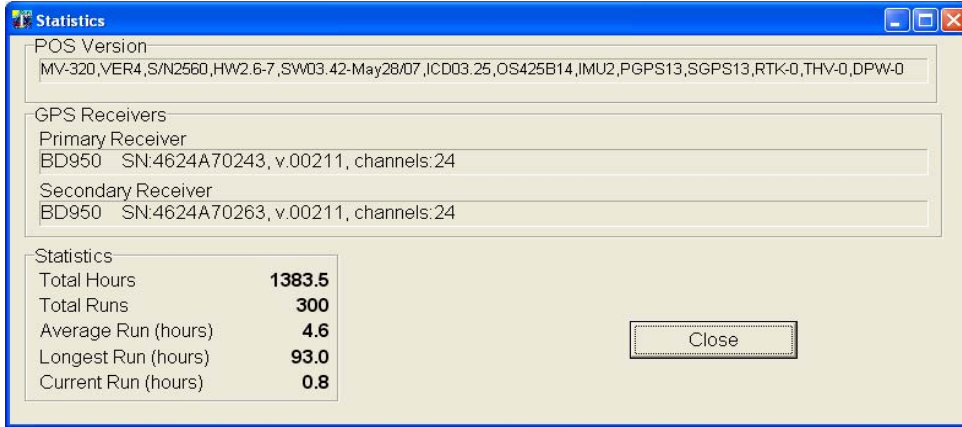
Port Antenna Serial # 60145158

Stbd Antenna Serial # 60130644

POS controller Version (Use Menu Help > About) 3.4.0.0

POS Version (Use Menu View > Statistics) MV-320,Ver 4

GPS Receivers  
 Primary Receiver Serial #: 4624A70243  
 Secondary Receiver Serial #: 4624A70263



## Calibration area

Location: Lake Washington, Seattle, WA

Approximate Position: \_\_\_\_\_ Lat \_\_\_\_\_  
 \_\_\_\_\_ Lon \_\_\_\_\_

47	39	35.8
122	15	35.6

DGPS Beacon Station: Whidbey Island

DGPS Receiver Serial#: 0328-12352-0001

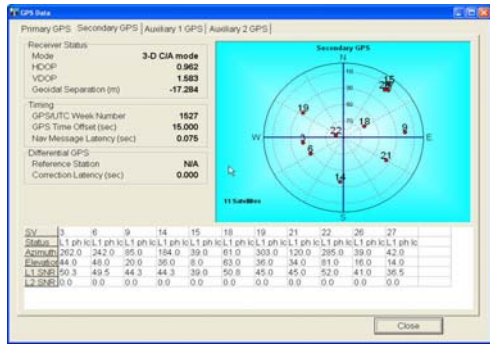
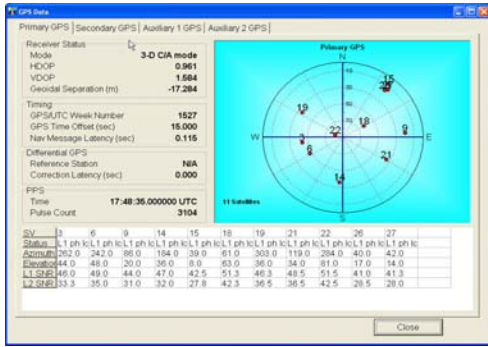
Frequency: 302

**Satellite Constellation**

(Use View> GPS Data)

**Primary GPS**

**Secondary GPS**



PDOP 1.823

(Use View> GAMS Solution)

**POS/MV Configuration Settings**

**Gams Parameter Setup**

(Use Settings > Installation > GAMS Intallation)

GAMS Parameter Setup

Two Antenna Separation (m): 1.831

Heading Calibration Threshold (deg): 0.500

Heading Correction (deg): 0.000

Baseline Vector:  
 X Component (m): -0.004  
 Y Component (m): 1.831  
 Z Component (m): 0.028

Buttons: Ok, Close, Apply, View

Configuration Notes:

---



---

**POS/MV Calibration**

**Calibration Procedure:**

(Refer to POS MV V4 Installation and Operation Guide, 4-25)

Start time: 1722 UTC

End time: 1723 UTC

Heading accuracy achieved for calibration: 0.324

**Calibration Results:**

**Gams Parameter Setup**

(Use Settings > Installation > GAMS Intallation)

GAMS Parameter Setup

Two Antenna Separation (m): 1.832

Heading Calibration Threshold (deg): 0.500

Heading Correction (deg): 0.000

Baseline Vector:  
 X Component (m): 0.016  
 Y Component (m): 1.831  
 Z Component (m): 0.026

Buttons: Ok, Close, Apply, View

GAMS Status Online Ready Online

Save Settings Yes

Calibration Notes:

---



---

**Save POS Settings on PC**

(Use File > Store POS Settings on PC)

File Name: C:\Documents and Settings\1018acq\Desktop\POS-MV Settings\GAMS\_Parameter\_104\_2009.nvm

## General Notes:

### The POS/MV uses a Right-Hand Orthogonal Reference System

The right-hand orthogonal system defines the following:

- The x-axis is in the fore-aft direction in the appropriate reference frame.
- The y-axis is perpendicular to the x-axis and points towards the right (starboard) side in the appropriate reference frame.
- The z-axis points downwards in the appropriate reference frame.

### The POS/MV uses a Tate-Bryant Rotation Sequence

Apply the rotation in the following order to bring the two frames of reference into complete alignment:

- a) Heading rotation - apply a right-hand screw rotation  $\theta_z$  about the z-axis to align one frame with the other.
- b) Pitch rotation - apply a right-hand screw rotation  $\theta_y$  about the once-rotated y-axis to align one frame with the other.
- c) Roll rotation - apply a right-hand screw rotation  $\theta_x$  about the twice-rotated x-axis to align one frame with the other.

# SETTINGS

## Input/Output Ports

(Use Settings > Input/Output Ports)

COM1

Input/Output Ports Set-up

COM1 | COM2 | COM3 | COM4 | COM5

Baud Rate: 9600

Parity:  None  Even  Odd

Data Bits:  7 Bits  8 Bits

Stop Bits:  1 Bit  2 Bits

Flow Control:  None  Hardware  XON/XOFF

Output Select: NMEA

NMEA Output:

- \$INGST
- \$INGGA
- \$INHDT
- \$INZDA
- \$INVTG
- \$PASHR

Update Rate: 1 Hz

Talker ID: IN

Roll Positive Sense:  Port Up  Starboard Up

Pitch Positive Sense:  Bow Up  Stern Up

Heave Positive Sense:  Heave Up  Heave Down

Input Select: None

Close Apply

COM2

Input/Output Ports Set-up

COM1 | COM2 | COM3 | COM4 | COM5

Baud Rate: 19200

Parity:  None  Even  Odd

Data Bits:  7 Bits  8 Bits

Stop Bits:  1 Bit  2 Bits

Flow Control:  None  Hardware  XON/XOFF

Output Select: Binary

Binary Output:

Update Rate: 25 Hz

Frame:  Sensor 1  Sensor 2

Formula Select: TSS1

Roll Positive Sense:  Port Up  Starboard Up

Pitch Positive Sense:  Bow Up  Stern Up

Heave Positive Sense:  Heave Up  Heave Down

Input Select: None

Close Apply

COM3

Input/Output Ports Set-up

COM1 | COM2 | COM3 | COM4 | COM5

Baud Rate: 9600

Parity:  None  Even  Odd

Data Bits:  7 Bits  8 Bits

Stop Bits:  1 Bit  2 Bits

Flow Control:  None  Hardware  XON/XOFF

Output Select: None

Input Select: Base 1 GPS

Base GPS Input:

Line:  Serial  Modem

Input Type: RTCM 1 or 9

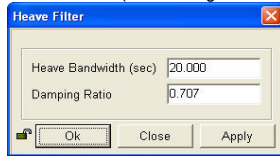
Modem Settings

Close Apply



## SETTINGS Continued

Heave Filter (Use Settings > Heave)



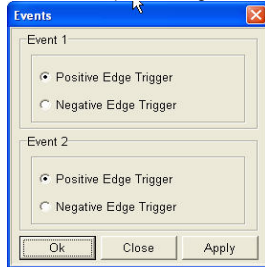
Heave Filter dialog box with the following fields:

Heave Bandwidth (sec)	20.000
Damping Ratio	0.707

Buttons: Ok, Close, Apply

Events

(Use Settings > Events)



Events dialog box with two event configurations:

Event 1

- Positive Edge Trigger
- Negative Edge Trigger

Event 2

- Positive Edge Trigger
- Negative Edge Trigger

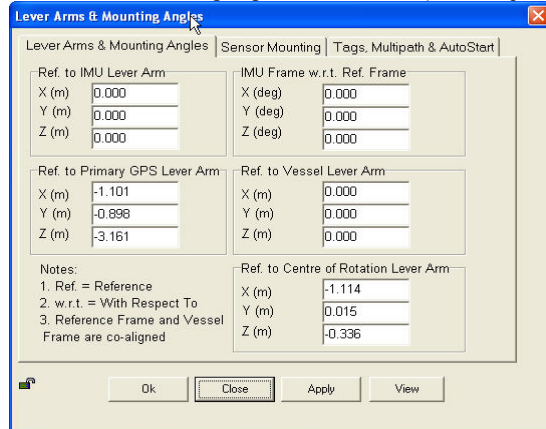
Buttons: Ok, Close, Apply

## INSTALLATION

(Use Settings > Installation)

Lever Arms and Mounting Angles

(Use Settings > Installation > Lever Arms and Offsets)



Lever Arms & Mounting Angles dialog box with the following sections:

- Ref. to IMU Lever Arm**

X (m)	0.000
Y (m)	0.000
Z (m)	0.000
- IMU Frame w.r.t. Ref. Frame**

X (deg)	0.000
Y (deg)	0.000
Z (deg)	0.000
- Ref. to Primary GPS Lever Arm**

X (m)	-1.101
Y (m)	-0.898
Z (m)	-3.161
- Ref. to Vessel Lever Arm**

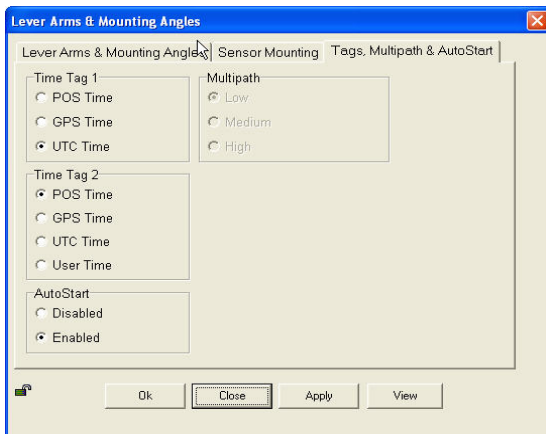
X (m)	0.000
Y (m)	0.000
Z (m)	0.000
- Notes:**
  1. Ref. = Reference
  2. w.r.t. = With Respect To
  3. Reference Frame and Vessel Frame are co-aligned
- Ref. to Centre of Rotation Lever Arm**

X (m)	-1.114
Y (m)	0.015
Z (m)	-0.336

Buttons: Ok, Close, Apply, View

Tags, Multipath and Auto Start

(Use Settings > Installation > Tags, Multipath and Auto Start)



Lever Arms & Mounting Angles dialog box - Tags, Multipath and Auto Start section:

- Time Tag 1**
  - POS Time
  - GPS Time
  - UTC Time
- Time Tag 2**
  - POS Time
  - GPS Time
  - UTC Time
  - User Time
- AutoStart**
  - Disabled
  - Enabled
- Multipath**
  - Low
  - Medium
  - High

Buttons: Ok, Close, Apply, View

### Sensor Mounting

(Use Settings > Installation > Sensor Mounting)

**Lever Arms & Mounting Angles** | **Sensor Mounting** | Tags, Multipath & AutoStart

Ref. to Aux. 1 GPS Lever Arm	Ref. to Aux. 2 GPS Lever Arm
X (m) 0.000	X (m) 0.000
Y (m) 0.000	Y (m) 0.000
Z (m) 0.000	Z (m) 0.000
Ref. to Sensor 1 Lever Arm	Sensor 1 Frame w.r.t. Ref. Frame
X (m) 0.000	X (deg) 0.000
Y (m) 0.000	Y (deg) 0.000
Z (m) 0.000	Z (deg) 0.000
Ref. to Sensor 2 Lever Arm	Sensor 2 Frame w.r.t. Ref. Frame
X (m) 0.000	X (deg) 0.000
Y (m) 0.000	Y (deg) 0.000
Z (m) 0.000	Z (deg) 0.000

Ok Close Apply View

### User Parameter Accuracy

(Use Settings > Installation > User Accuracy)

**User Parameter Accuracy**

RMS Accuracy

Attitude (deg)	0.050
Heading (deg)	0.050
Position (m)	2.000
Velocity (m/s)	0.500

Ok Close Apply

### GPS Receiver Configuration

(Use Settings> Installation> GPS Receiver Configuration)

#### Primary GPS Receiver

**Gps Receiver Configuration**

Primary GPS Receiver | Secondary GPS Receiver

Primary GPS

GPS Output Rate: 1 Hz

GPS 1 Port

Baud Rate: 9600

Parity:  None  Even  Odd

Data Bits:  7 Bits  8 Bits

Stop Bits:  1 Bit  2 Bits

Auto Configuration:  Enabled  Disabled

Ok Close Apply

#### Secondary GPS Receiver

**Gps Receiver Configuration**

Primary GPS Receiver | Secondary GPS Receiver

Secondary GPS

GPS Output Rate: 1 Hz

GPS 2 Port

Baud Rate: 9600

Parity:  None  Even  Odd

Data Bits:  7 Bits  8 Bits

Stop Bits:  1 Bit  2 Bits

Auto Configuration:  Enabled  Disabled

Ok Close Apply

**FAIRWEATHER**

**Multibeam Echosounder Calibration**

**Launch 1018**

Vessel

4/16/2009 | 106 | L. Washington  
Date Dn Local Area

FOO Ringel, CST Morgan, LT Welton, ENS Morgan  
Calibrating Hydrographer(s)

8101 | 1018 | not available  
MBES System MBES System Location Date of most recent EED/Factory Check

3102026 | 34497  
Sonar Serial Number Processing Unit Serial Number

Hull mounted swing arm | 03/20/2009  
Sonar Mounting Configuration Date of current offset measurement/verification

POSMV v4 GPS (DGPS corrected) | 04/15/2009  
Description of Positioning System Date of most recent positioning system calibration

**Acquisition Log**

4/16/2009 | 106 | L. Washington | Calm  
Date Dn Local Area Wx

| 30-190 feet  
Bottom Type Approximate Water Depth

Welton, ENS Morgan, Raymond, Heiner  
Personnel on board

Comments

TH\_1018\_Patch\_Test\_Dn105  
TrueHeave filename

081060818 | 0:00 | | | | |  
SV Cast #1 filename UTC Time Lat Lon Depth Ext. Depth

| | | | | |  
SV Cast #2 filename UTC Time Lat Lon Depth Ext. Depth

**ROLL**

SV Cast #	XTF Line Filename	Heading	Speed (kts)	Remarks
	005_1832.81X	3	5.9	roll
	005_1838.81X	183	6.0	roll
	005_1844.81X	03	6.0	roll

**PITCH**

SV Cast #	XTF Line Filename	Heading	Speed (kts)	Remarks
	001_1730.81X	274	5.1	
	001_1741.81X	092	5.1	
	002_1751.81X	272	5.2	
	002_1801.81X	092	5.1	

**HEADING/YAW**

SV Cast #	XTF Line Filename	Heading	Speed (kts)	Remarks
91060818	001_1730.81X	274	5.1	Heading
	001_1741.81X	092	5.1	Heading
	002_1751.81X	272	5.2	Heading
	002_1801.81X	092	5.1	Heading (1805 overtaking boat noise)

**NAV TIME LATENCY**

SV Cast #	XTF Line Filename	Heading	Speed (kts)	Remarks
	001_1811.81X	272	4.8	timing
	001_1823.81X	092	8.0	timing
	001_1741.81X	092	5.1	Heading

**Processing Log**

4/16/2009 | DN106 | ENS Morgan  
 Date Dn Personnel

- Data converted --> HDCS\_Data in CARIS
- TrueHeave applied yes
- SVP applied yes
- Tide applied zerotide.tid
- Zone file na
- Lines merged
- Data cleaned to remove gross fliers

**Compute correctors in this order**

- 1. Precise Timing
- 2. Pitch bias
- 3. Heading bias
- 4. Roll bias

Do not enter/apply correctors until all evaluations are complete and analyzed.

**PATCH TEST RESULTS/CORRECTORS**

Evaluators	Latency (sec)	Pitch (deg)	Roll (deg)	Yaw (deg)
FOO (in progress)	-0.05	-0.80	2.88	-0.40
CST	0.00	0.30	2.86	-0.50
Nick	0.03	-0.94	2.86	-0.35
Bri	-0.03	-1.06	2.90	-0.10
<b>Averages</b>	-0.01	-0.63	2.88	-0.34
<b>Standard Deviation</b>	0.04	0.63	0.13	0.02
<b>FINAL VALUES</b>	0.00	-0.63	2.88	-0.34
<b>Final Values based on</b>	CST/FOO	Averages	Averages	Averages

Resulting HVF File Name FA\_1018\_Reson8101\_2009

**Actual values used**  
 MRU Align StdDev  
 0.035 gyro  
 MRU Align  
 0.075 StdDev Roll/Pitch

MRU Align StdDev gyro 0.17 Value from standard deviation of Heading offset values

MRU Align StdDev Roll/Pitch 0.32 Value from averaged standard deviations of pitch and roll offset values

**NARRATIVE**

Values based on two patch tests- one performed on DN106 in Lake Washington using the bounded slope method and one performed on DN107 on the Shilshole reference surface using the target method.

Initial MRU values were too high, TPU values reassessed with outliers removed.

HVF Hydrographic Vessel File created or updated with current offsets

Name: Ringel, Welton, Morgan

Date: 4/18/09

# FAIRWEATHER

## Multibeam Echosounder Calibration

Launch 1018

Vessel

5/24/2009 | 144 | Ernest Sound, Vixen Inlet  
Date Dn Local Area

Ringel, Argento, Francksen, Andrews  
Calibrating Hydrographer(s)

8125 | 1018 | unknown (on loan from RUDE)  
MBES System MBES System Location Date of most recent EED/Factory Check

4400007 | 31562  
Sonar Serial Number Processing Unit Serial Number

Sled hull mount | 4/29/2009  
Sonar Mounting Configuration Date of current offset measurement/verification

POSMV w/ DGPS correctors | 4/15/2009  
Description of Positioning System Date of most recent positioning system calibration

### Acquisition Log

5/24/2009 | 144 | Ernest Sound, Vixen Inlet | Wind lgt vrb, waves <1ft (Awesome)  
Date Dn Local Area Wx

| 20 meters  
Bottom Type Approximate Water Depth

Argento, Ringel, Francksen, Andrews  
Personnel on board

Comments

2009-144\_1018.002  
TrueHeave filename

091441904.svp | 19:04 | 55/48/41 | 132/04/16 | 42  
SV Cast #1 filename UTC Time Lat Lon Depth Ext. Depth

| | | | | |  
SV Cast #2 filename UTC Time Lat Lon Depth Ext. Depth



# Processing Log

6/24/2009 | 144 | Argento  
 Date Dn Personnel

Data converted --> HDCS\_Data in CARIS

TrueHeave applied ACA

SVP applied Previous in Time

Tide applied ACA

Zone file O119FA2009CORP.zdf

Lines merged

Data cleaned to remove gross fliers

**Compute correctors in this order**

1. Precise Timing      2. Pitch bias      3. Heading bias      4. Roll bias

Do not enter/apply correctors until all evaluations are complete and analyzed.

**PATCH TEST RESULTS/CORRECTORS**

Evaluators	Latency (sec)	Pitch (deg)	Roll (deg)	Yaw (deg)
Argento	0.00	-0.10	-1.55	-1.70
<b>Averages</b>	0.00	-0.10	-1.55	-1.70
<b>Standard Deviation</b>	0.00	0.00	0.00	0.00
<b>FINAL VALUES</b>	0.00	-0.10	-1.55	-1.70

Final Values based on Argento and review by FOO

Resulting HVF File Name FA\_1018\_Reson8125\_2009

**MRU Align StdDev gyro** 0.00 Value from standard deviation of Heading offset values  
**MRU Align StdDev Roll/Pitch** 0.00 Value from averaged standard deviations of pitch and roll offset values

**NARRATIVE**

Multiple patch values were not obtained for this testing, therefore the TPE values for MRU alignment are zero.  
 Values were confirmed by CST and FOO.

Values entered under Dn143 to allow for all lines.

HVF Hydrographic Vessel File created or updated with current offsets

Name: Argento

Date: 5/24/2009



# FAIRWEATHER

## Multibeam Echosounder Calibration

Launch 1018

Vessel

6/27/2009	178	Shumagin Islands, Near Northeast Harbor
Date	Dn	Local Area
Welton, FOO Ringel, CST Morgan		
Calibrating Hydrographer(s)		
8125	1018	unknown (on loan from RUDE)
MBES System	MBES System Location	Date of most recent EED/Factory Check
4400007		31562
Sonar Serial Number		Processing Unit Serial Number
Sled hull mount		4/29/2009
Sonar Mounting Configuration		Date of current offset measurement/verification
POSMV w/ DGPS correctors		4/15/2009
Description of Positioning System		Date of most recent positioning system calibration

## Acquisition Log

6/27/2009	178	Shumagin Islands, Near Northeast Harbor	Wind lgt vrb, waves <1ft (Awesome)
Date	Dn	Local Area	Wx
rock			20-30 meters
Bottom Type			Approximate Water Depth
Froelich, Francksen, Walker			
Personnel on board			

Comments

2009-178\_1018.000

TrueHeave filename

SV Cast #1 filename	UTC Time	Lat	Lon	Depth	Ext. Depth
SV Cast #2 filename	UTC Time	Lat	Lon	Depth	Ext. Depth



# Processing Log

6/27/2009 | 178 |  
 Date | Dn | Personnel

Data converted --> HDCS\_Data in CARIS

TrueHeave applied

SVP applied Previous in Time

Tide applied

Zone file predicted- Sand Point, AK

Lines merged

Data cleaned to remove gross fliers

### Compute correctors in this order

1. Precise Timing      2. Pitch bias      3. Heading bias      4. Roll bias

Do not enter/apply correctors until all evaluations are complete and analyzed.

### PATCH TEST RESULTS/CORRECTORS

Evaluators	Latency (sec)	Pitch (deg)	Roll (deg)	Yaw (deg)
Welton	0.00	-0.90	-1.98	-2.20
FOO	0.00	-0.30	-1.95	-1.70
CST	0.00	-0.40	-1.91	-1.50
<b>Averages</b>	0.00	-0.53	-1.95	-1.80
<b>Standard Deviation</b>	0.00	0.32	0.04	0.36
<b>FINAL VALUES</b>	0.00	-0.53	-1.95	-1.80

Final Values based on Averages

Resulting HVF File Name added to FA\_1018\_Reson8125\_2009

**MRU Align StdDev gyro** 0.36 Value from standard deviation of Heading offset values  
**MRU Align StdDev Roll/Pitch** 0.18 Value from averaged standard deviations of pitch and roll offset values





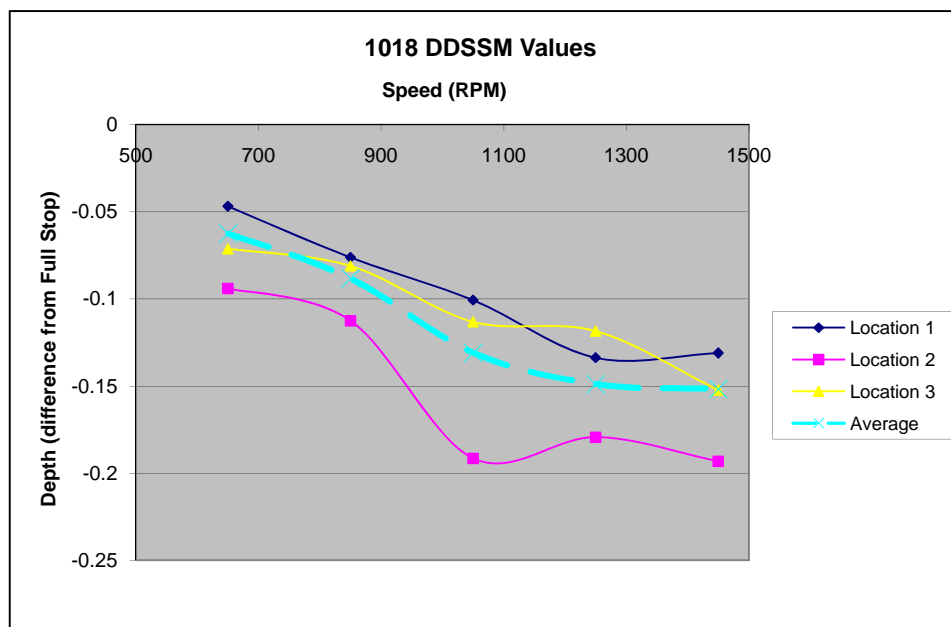
## DDSSM DATA PROCESSING AND RESULTS FORM

Date 4/18/2009      DN 106      Wind calm  
 Vessel # 1018      Location Lk Washington      Seas calm  
 Average Depth \_\_\_\_\_      Personnel \_\_\_\_\_

SVP file loaded \_\_\_\_\_

Tide file loaded \_\_\_\_\_

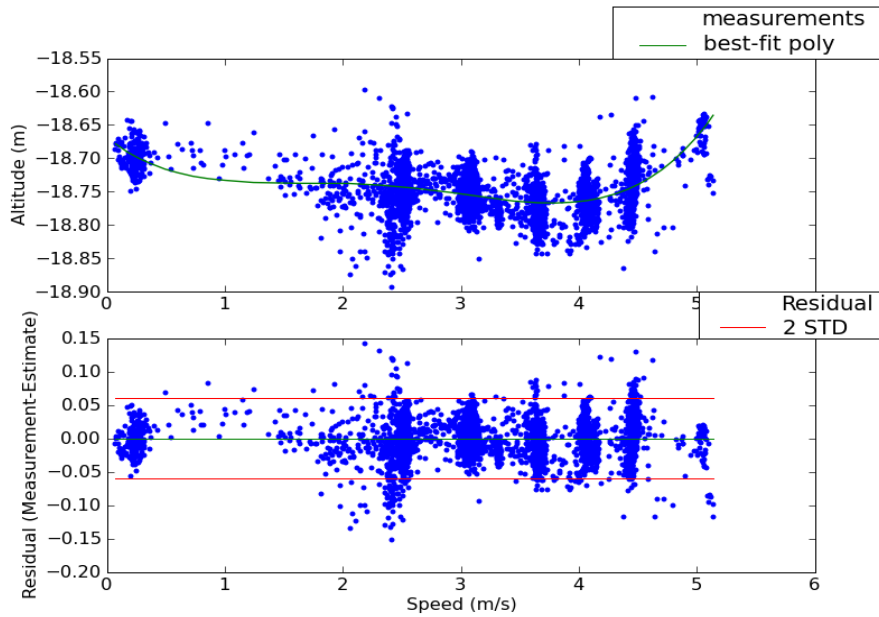
Speed (m/s)	Speed (Kts)	Speed (RPM)	Hypack Line Name	CARIS Line Name	Depth Loc 1	Diff Loc 1	Depth Loc 2	Diff Loc 2	Depth Loc 3	Diff Loc 3	Average
0	0	0			27.6557457		25.9568637		29.8462362		
2.52	4.9	650	007_1942.81X	007_1942	27.6090035	-0.0467422	25.8629032	-0.0939605	29.7750175	-0.0712187	-0.0624817
3.07	5.9	850	007_1952.81X	007_1952	27.5795859	-0.0761598	25.844337	-0.1125267	29.7651968	-0.0810394	-0.0882821
3.66	7	1050	007_2001.81X	007_2001	27.5550541	-0.1006916	25.7653247	-0.191539	29.7330816	-0.1131546	-0.130974
4.06	7.9	1250	007_2008.81X	007_2008	27.5219777	-0.133768	25.7774865	-0.1793773	29.7278022	-0.118434	-0.1489711
4.47	8.7	1450	007_2016.81X	007_2016	27.5246716	-0.1310741	25.7636516	-0.1932122	29.6939714	-0.1522648	-0.1517868



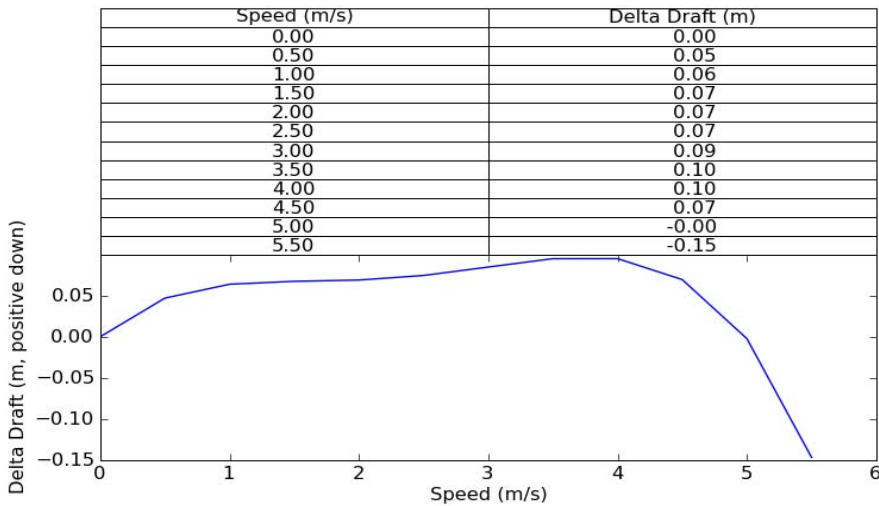
# Ellipsoid Referenced Dynamic Draft

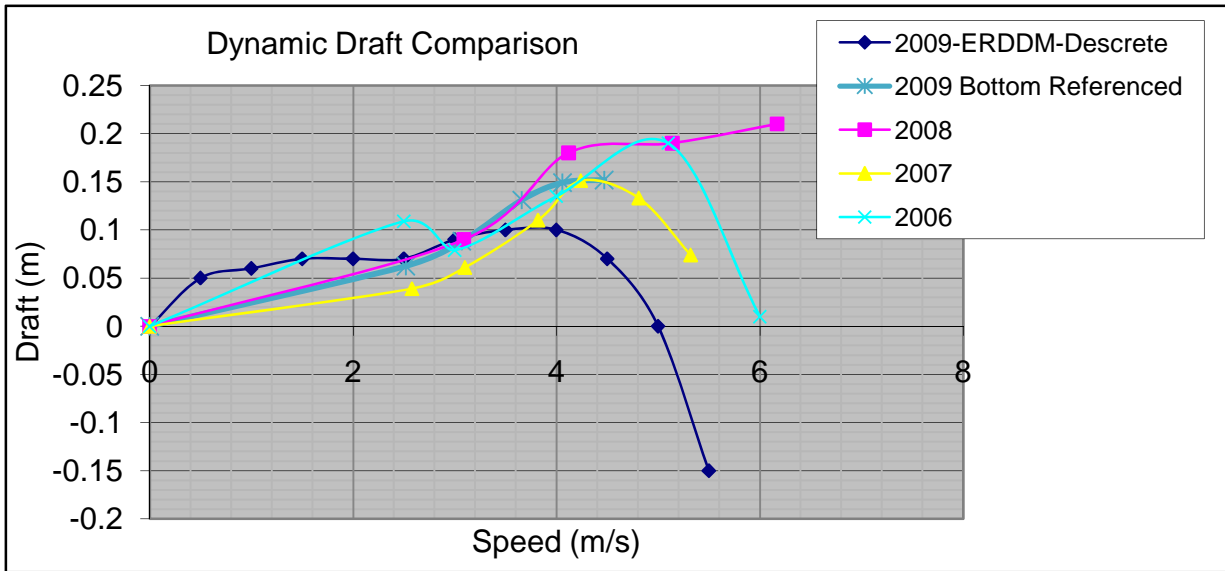
Launch 1018

4/16/2009	106 Lake Washington	Rice
Date	DN	Local Area Processor
SEAI	TH_1018_patch_test_dn105.000.002	1018_ERDDM.txt
Primary Station	POSPac File	SBET File
proc_erddm.py, v0.12	4	
Processing Method	Coefficients	



$$-3.59e-003 * X^3 + 3.31e-002 * X^2 + -1.04e-001 * X$$





**2009 HVF Values**

**2009-ERDDM-Descrete**

speed (m/s)	draft (m)
0	0
0.5	0.05
1	0.06
1.5	0.07
2	0.07
2.5	0.07
3	0.09
3.5	0.1
4	0.1
4.5	0.07
5	0
5.5	-0.15

**2009 Bottom Referenced**

speed (m/s)	draft (m)
0	0
2.52	0.062
3.07	0.088
3.66	0.131
4.06	0.149
4.47	0.152

**2008**

speed (m/s)	draft (m)
0	0
3.09	0.09
4.12	0.18
5.14	0.19
6.17	0.21

**2007**

speed (m/s)	draft (m)
0	0
2.58	0.039
3.1	0.061
3.82	0.11
4.24	0.151
4.81	0.133
5.32	0.074

**2006**

speed (m/s)	draft (m)
0	0
2.5	0.109
3	0.079
4	0.135
5.1	0.19
6	0.01

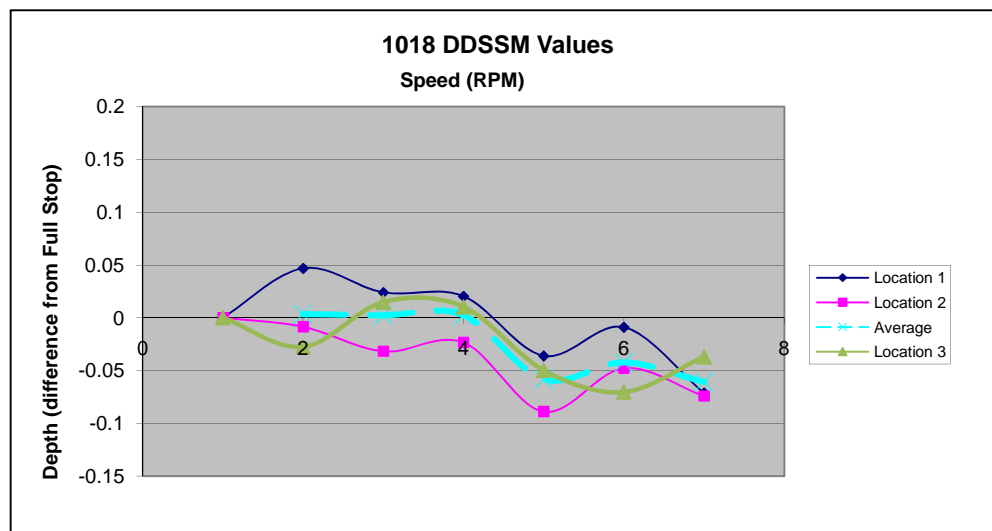


## DDSSM DATA PROCESSING AND RESULTS FORM

**NOTE: Conducted with sled-mounted 8125.**

Date	4/18/2009	DN	219	Wind	calm
Vessel #	1018	Location	Dutch Harbor, AK	Seas	calm
Average Depth	16 meters	Personnel	Welton, Rice, Beduhn		
SVP file loaded	092192151.svp				
Tide file loaded	946-2620	9462620.tid			

Speed (m/s)	Speed (Kts)	Speed (RPM)	Hypack Line Name	Depth Loc 1	Diff Loc 1	Depth Loc 2	Diff Loc 2	Depth Loc 3	Diff Loc 3	Average
0	0	0	2142	17.5421699	0	<b>16.9987276</b>	0	16.87650376	0	
	5	650	2050/2055	17.58894816	0.046778256	16.99016	-0.008567602	16.84873958	-0.027764188	0.003482155
	5.5	774	2123/2128	17.56613327	0.023963362	16.96695	-0.031777602	16.89124567	0.014741905	0.002309222
	6.3	890	2101/2105	17.56247363	0.020303723	16.97538	-0.023347602	16.88678976	0.010285998	0.00241404
	7.1/7.2	1060	2133/2136	17.50604808	-0.036121821	16.9098	-0.088927602	16.82672642	-0.049777349	-0.058275591
	7.4/7.5	1120	2109/2112	17.53315974	-0.009010164	16.951	-0.047727602	16.80605949	-0.070444274	-0.042394013
	8.4/8.5	1425	2116/2119	17.51770889	-0.07123927	16.916	-0.07416	16.8116773	-0.037062276	-0.060820515



## HULL 2801 (RA4) VESSEL OFFSET MEASUREMENTS CERTIFICATION REPORT 2008

---

**Vessel:** Hull 2801 (RA4) 28 ft. Aluminum Jensen Survey Launch

**Sonar / Instrument / etc.:** Reson 7125

**Written By:** CST Jacobson

**Report Date:** 4/10/08

### Background:

The following report gives a technical description of how vessel 2801 offset measurements were derived so that future surveys may accurately reproduce these results.

During the 2007-2008 winter import a brand new Jensen (2801) launch was constructed and delivered to RAINIER. Personnel from the National Geodetic Survey's Geodetic Services Division determine the spatial relationship of various sensors and reference points in relation to the POS/MV IMU. A report detailing this survey is included with the RAINIER's 2008 System Readiness package.

Two of the benchmarks positioned by NGS personnel are located on a sonar mounting bracket which was built precise dimensional standards. These two benchmarks and blueprints of the mounting bracket allowed for the determination of the exact orientation of the Reson 7125 sonar projectors once they were mounted.

### Calibration Location, Date, and Personnel:

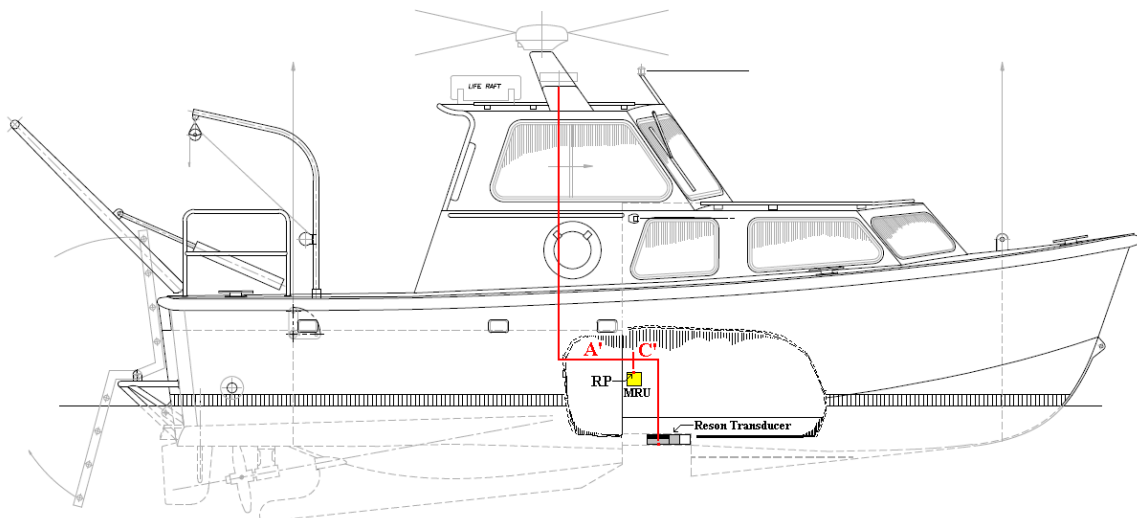
**Personnel:** CST Jacobson

**Coxwain:** N/A

**Location:** Sand point, WA

**Date:** 4/9/08 and 4/10/08

**Status:** Measurements were derived using both the NGS survey and blueprints of the sonar mounting bracket.



**Figure 1**

A' – The measurement was obtained by averaging the northing values of the port side and starboard side antenna pulled directly from the NGS survey report.

0.882	PORT SIDE GPS ANTENNA
<u>0.885</u>	STARBOARD SIDE GPS ANTENNA
0.8835	AVERAGE Value of antenna to RP

C' – The distance from sonar head acoustic center to RP can not be directly measured, but instead must be derived by manipulating several independent measurements. All of these dimensions (See fig. 2) were taken directly from the NGS survey, the mounting plate blueprints, or the Reson 7125 manual.

0.3520	average of distances between the two Plate RMs and the IMU
-0.0350	distance from plate RM to bolt-hole
-0.0170	bolt-hole to edge of Reson receiver
-0.1050	thickness of Reson receiver
<u>-0.1390</u>	edge of Reson receiver to Reson transmitter acoustic center
0.0560	The distance from sonar head acoustic center to RP

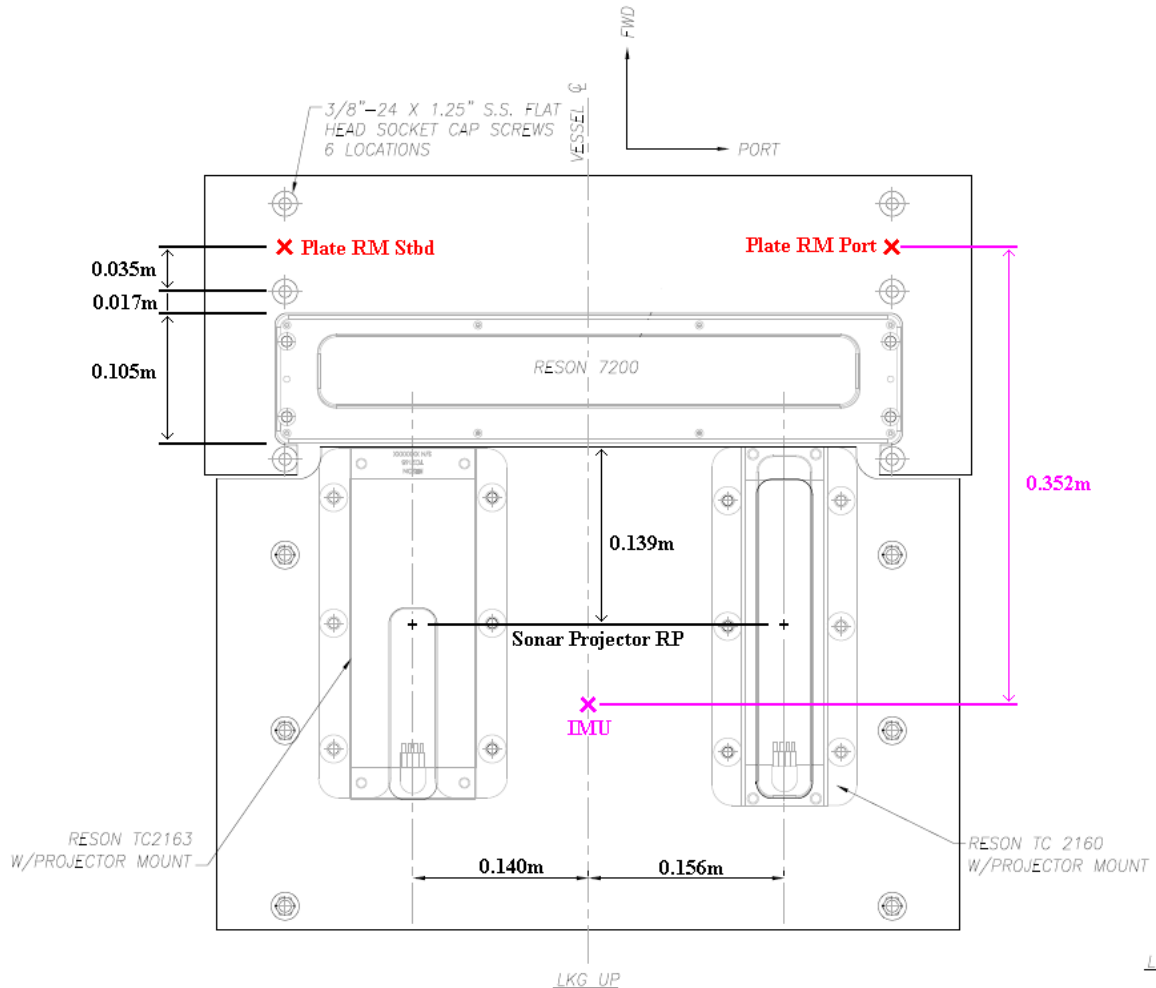
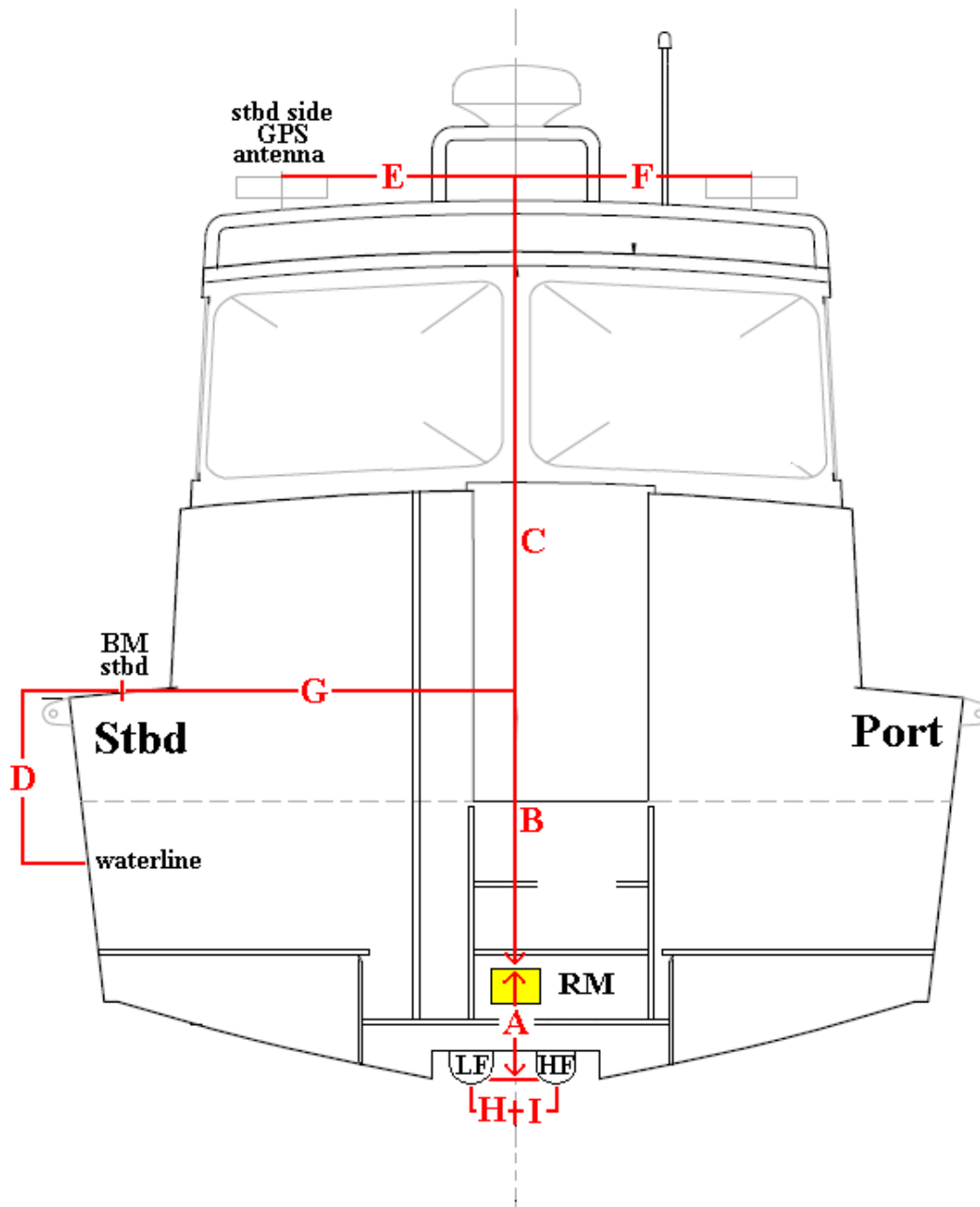


Figure 2



*Figure 3 Atwartship view of 2801 (RA-4) looking aft*

A - The distance from the waterline to the deck was determined by measuring directly from the deck to the waterline while the launch was in the water. A carpenter level was held level to the deck while a steel tape was used to measure directly to the surface of the water. Both the port and starboard measurements were taken and averaged together for a final value.

0.4775	average of distances between the two Plate RMs and the IMU
<u>-0.0260</u>	corrector from face of Reson transmitter to the acoustic center
0.4515	The distance from sonar head acoustic center to IMU

B – The measurement from the MRU to the deck benchmarks was taken directly from the NGS survey. The distance to the port and starboard BMs was the same, 1.078m.

C – This measurement was obtained by averaging the height values of the port side and starboard side antenna pulled directly from the NGS survey report.

3 . 452                      PORT SIDE GPS ANTENNA  
3 . 456                      STARBOARD SIDE GPS ANTENNA  
 3 . 454                      AVERAGE Value of antenna to RP

D – The distance from the waterline to the deck was determined by measuring directly from the deck BM to the waterline while the launch was in the water. A carpenter level was held level to the deck while a steel tape was used to measure directly to the surface of the water. Both the port and starboard measurements were taken and averaged together for a final value.

0 . 9440                      Port side BM to the waterline  
0 . 9710                      Starboard side BM to the waterline  
 0 . 9575                      AVERAGE Value deck BMs to waterline

E – The measurement to the starboard GPS antenna was obtained directly from the NGS survey report, 0.495m.

F – The measurement to the port GPS antenna obtained directly from the NGS survey report, 0.505m.

G – The measurement to the port deck BM obtained directly from the NGS survey report, 1.452m.

H – The measurement to the Reson low frequency transmitter acoustic center was obtained directly from the mounting plate blueprints, 0.140m.

I – The measurement to the Reson high frequency transmitter acoustic center was obtained directly from the mounting plate blueprints, 0.156m.

**Results and Final Error Estimates:**

		Y (along-ship)	
		date	
		cm.	measured
RP to GPS	A'	88.4	4/10/08
RP to Reson acoustic center	C'	5.6	4/10/08

		X (athwartship)		Z (vertical)	
		cm.	date measured	cm.	date measured
MRU to Reson acoustic center	A	n/a	n/a	45.2	4/10/08
MRU to deck BM	B	n/a	n/a	107.8	4/10/08
MRU to GPS antenna	C	n/a	n/a	345.6	4/10/08
Deck BM to waterline	D	n/a	n/a	95.8	4/10/08
Centerline to Stbd GPS	E	49.5	4/10/08	n/a	n/a
Centerline to Port GPS	F	50.5	4/10/08	n/a	n/a
Centerline to Starboard deck BM	G	145.2	4/10/08	n/a	n/a
Centerline to low freq Reson	H	14.0	4/10/08	n/a	n/a
Centerline to high freq Reson	I	15.6	4/10/08	n/a	n/a

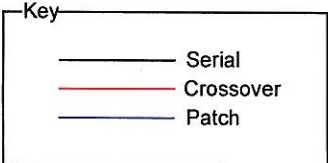
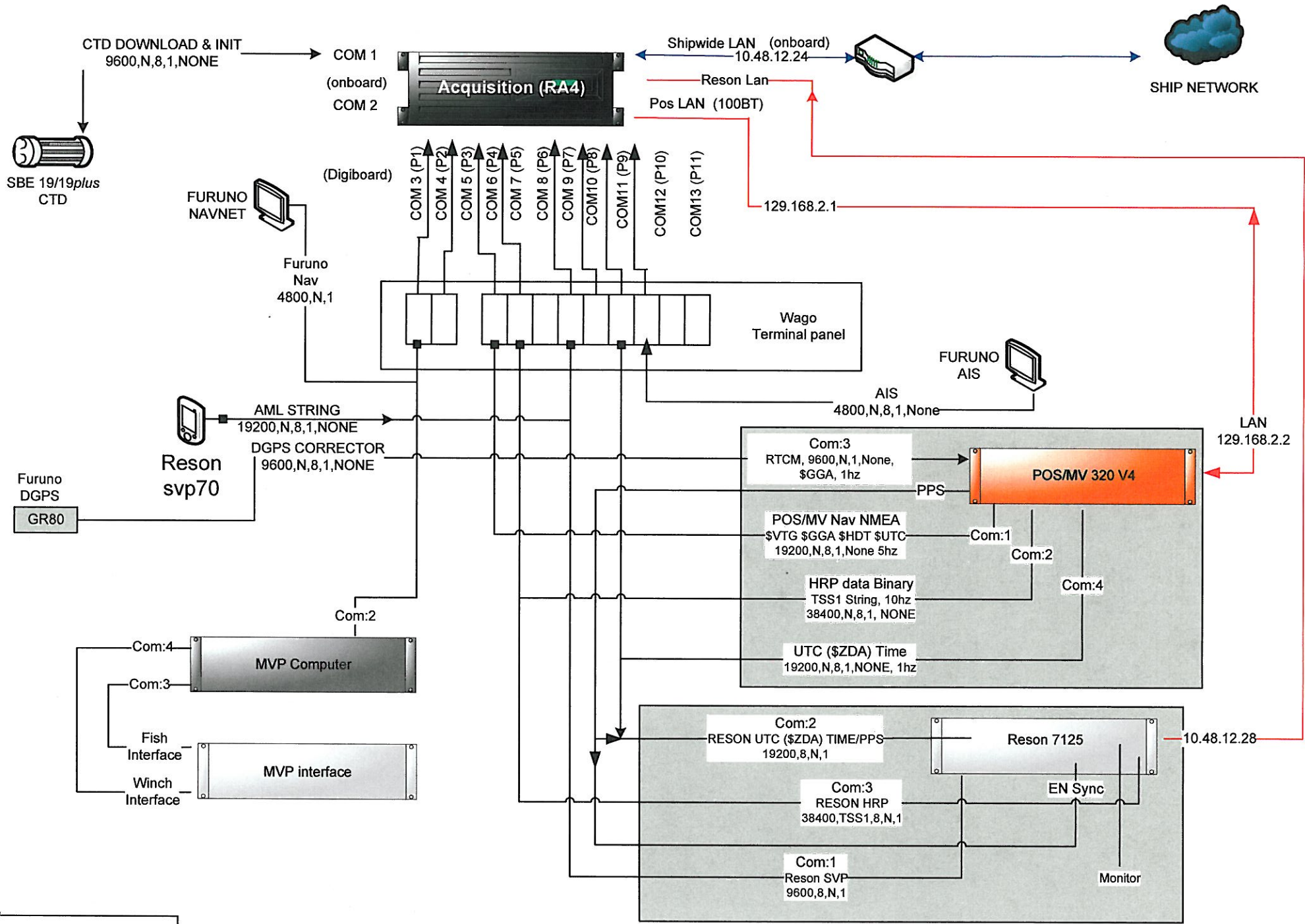
**CARIS** configuration is based on a Reference Position (RP)  
 The RP has been defined to coincide with the location of the MRU

**X** athwartship distance [+ starboard]  
**Y** along-ship distance [+ towards bow]  
**Z** vertical distance [+ into water]

<b>X</b>	RP to Reson LF transducer (equals H )	0.140	Reson LF
	RP to Reson HF transducer (equals I )	-0.156	
	MRU is RP (mounted centerline)	0.000	Reson HF
<b>Y</b>	RP to Reson LF transducer (equals C' )	0.056	Navigation
	RP to Reson HF transducer (equals C' )	0.056	Gyro
	MRU is RP	0.000	Heave Pitch Roll
<b>Z</b>	RP to Reson LF transducer (equals A )	0.452	
	RP to Reson HF transducer (equals A )	0.452	
	MRU is RP	0.000	Waterline
	MRU to waterline (equals B-D)	-0.121	

## Recommendations

Due to the combination of the NGS survey and the availability of precise measured blueprints, the offsets of launch 2801 are very precise. Errors in any of the offset measurements should be less than one centimeter. This being disclosed it is the opinion of the hydrographer that the measurements obtained and/or confirmed for this report are an accurate reflection of offset distances of vessel 2801. These offset measurements should be used to create the HVF for the 2008 field season.



### Launch 2801 Wire Diagram [RA-4]-7125

Rev 1.0 Rev 1.1 (6-12-09)	3-20-08	Garry Streeer J. Tegeder
------------------------------	---------	-----------------------------

# FAIRWEATHER

## Multibeam Echosounder Calibration

2801\_7125\_200

Vessel

9/28/2009 | 271 | Juneau, AK  
Date Dn Local Area

CST Morgan, PS Forfinski, LT Ringel  
Calibrating Hydrographer(s)

Reson 7125 200kHz | Launch 2801 | unknown  
MBES System MBES System Location Date of most recent EED/Factory Check

Sonar Serial Number | Processing Unit Serial Number

Hull Mounted | April 10, 2008  
Sonar Mounting Configuration Date of current offset measurement/verification

TSS POS/MV 320 (version 4) |  
Description of Positioning System Date of most recent positioning system calibration

### Acquisition Log

9/28/2009 | 271 | Juneau, AK | calm  
Date Dn Local Area Wx

Feature and bounded slope |  
Bottom Type Approximate Water Depth

Morgan, Forfinski, Raymond  
Personnel on board

Ran as equidistant  
Comments

TrueHeave filename

09271185 | 185X | 58-16-55.29 | 134-23-36.19 | |  
SV Cast #1 filename UTC Time Lat Lon Depth Ext. Depth

| | | | | |  
SV Cast #2 filename UTC Time Lat Lon Depth Ext. Depth

| | | | | |  
SV Cast #3 filename UTC Time Lat Lon Depth Ext. Depth





**Processing Log**

Date \_\_\_\_\_ Dn \_\_\_\_\_ Personnel Forfinski

Data converted --> HDCS\_Data in CARIS

TrueHeave applied \_\_\_\_\_

SVP applied \_\_\_\_\_

Tide applied \_\_\_\_\_

Zone file \_\_\_\_\_

Lines merged

Data cleaned to remove gross fliers

**Compute correctors in this order**

1. Precise Timing

2. Pitch bias

3. Heading bias

4. Roll bias

Do not enter/apply correctors until all evaluations are complete and analyzed.

**PATCH TEST RESULTS/CORRECTORS**

Evaluators	Latency (sec)	Pitch (deg)	Roll (deg)	Yaw (deg)
Forfinski	0.00	-0.77	-0.20	0.80
Morgan	0.00	-0.70	-0.19	0.60
LT Ringel	0.00	-0.80	-0.21	1.00
<b>Averages</b>	0.00	-0.76	-0.20	0.80
<b>Standard Deviation</b>	0.00	0.05	0.01	0.20
<b>FINAL VALUES</b>	0.00	-0.76	-0.20	0.80

Final Values based on averages

Resulting HVF File Name 2801\_Rsn7125\_200kHz\_256bms\_2009.hvf

MRU Align StdDev gyro 0.20 Value from standard deviation of Heading offset values

MRU Align StdDev Roll/Pitch 0.03 Value from averaged standard deviations of pitch and roll offset values

**NARRATIVE**

HVF Hydrographic Vessel File created or updated with current offsets

Name: CST Morgan

Date: 10/7/2009

# FAIRWEATHER

## Multibeam Echosounder Calibration

2801\_7125\_400

Vessel

9/30/2009 | 273 | Glacier Bay, Russel Island  
Date Dn Local Area

CST Morgan, PS Forfinski, LT Ringel  
Calibrating Hydrographer(s)

Reson 7125 | Launch 2801 |  
MBES System MBES System Location Date of most recent EED/Factory Check

Sonar Serial Number | Processing Unit Serial Number

Hull mounted | 4/10/2008  
Sonar Mounting Configuration Date of current offset measurement/verification

Description of Positioning System | Date of most recent positioning system calibration

### Acquisition Log

9/30/2009 | 273 | Glacier Bay, Russel Island | calm  
Date Dn Local Area Wx

varied |  
Bottom Type Approximate Water Depth

CST Morgan, PS Forfinski  
Personnel on board

Comments

TrueHeave filename

SV Cast #1 filename | UTC Time | 58d57'15.8526"N | 136d52'30.4976"W | Depth | Ext. Depth

SV Cast #2 filename | UTC Time | Lat | Lon | Depth | Ext. Depth

view parallel to track, one line with induced roll (outerbeam) or same lines over bounded slope or feature (nadir) [run same direction, different speed]

**NAV TIME LATENCY**

SV Cast #	Line Filename	Heading	Speed (kts)	Remarks

view parallel to track, same line (nadir) over feature or bounded slope [opposite direction, same speed]

**PITCH**

SV Cast #	Line Filename	Heading	Speed (kts)	Remarks
	2009P_2731754.HSX	SSW	4	no pos file
	2009P_2731759.HSX	NNE	4	no pos file
	1820	SSW	4	POS logging
	1827	NNE	4	POS logging, possible Hdg3 line

view parallel to track, offset lines from feature or slope (outerbeams) [opposite direction, same speed]

**HEADING/YAW**

SV Cast #	Line Filename	Heading	Speed (kts)	Remarks
	2009P_2731806.HSX	SSW	5	no pos file
	2009P_2731811.HSX	NNE	5	no pos file
	1834	SSW	4	Hdg4
	1843	E	4	Hdg5
	1848	W	4.0	Hdg6
	1854	112	4.0	Hdg7
	1858	294	5.0	Hdg8, higher current

view across track, same line [run in flat area in opposite direction, same speed]

**ROLL**

SV Cast #	Line Filename	Heading	Speed (kts)	Remarks
	1903	SE	4.5	R1
	1908	NW		R2

view across track, same line [run in flat area in opposite direction, same speed]

**DD**

SV Cast #	Line Filename	Heading	Speed (kts)	Remarks
	2019	SE	4.6	DD1
	2029	SE	6.3	DD2
	2038	SE	8.2	DD3
	2045	SE	10.2	DD4
	2055		stop	DD5
	2057		stop	DD6
	2059		stop	DD7

# Processing Log

10/1/2009 | 274 | PS Forfinski  
 Date | Dn | Personnel

Data converted --> HDCS\_Data in CARIS

TrueHeave applied T:\Testing\_2009\PreProcess\2801\_7125\_Patch Test\2009-273\2009-273\_2801.000

SVP applied T:\Testing\_2009\SVP\2801 Patch Test\GBNP\2801\_7125\_PatchTest.svp

Tide applied \_\_\_\_\_

Zone file I:\2009\_Processed\_Data\Tide\OPR\_O351\_FA\_09\Predicted\O351FA2009CORP.zdf

Lines merged

Data cleaned to remove gross fliers

### Compute correctors in this order

1. Precise Timing      2. Pitch bias      3. Heading bias      4. Roll bias

Do not enter/apply correctors until all evaluations are complete and analyzed.

### PATCH TEST RESULTS/CORRECTORS

Evaluators	Latency (sec)	Pitch (deg)	Roll (deg)	Yaw (deg)
PS Forfinski	0.00	-0.60	-0.31	0.53
CST Morgan	0.00	-0.60	-0.28	0.55
LT Ringel	0.00	-0.80	-0.26	0.68
Averages	0.00	-0.67	-0.28	0.59
Standard Deviation	0.00	0.12	0.03	0.08
FINAL VALUES	0.00	-0.67	-0.28	0.59

Final Values based on Averages

Resulting HVF File Name 2801\_Rsn7125\_400kHz\_512bms\_2009.hvf

MRU Align StdDev gyro 0.08 Value from standard deviation of Heading offset values  
 MRU Align StdDev Roll/Pitch 0.07 Value from averaged standard deviations of pitch and roll offset values

### NARRATIVE

HVF Hydrographic Vessel File created or updated with current offsets

Name: CST Morgan Date: 10/7/2009

## 2801 Dynamic Draft SYSTEM READINESS REPORT 2009

**Vessel:** RA-4; Hull # 2801  
**Sonar:** Reson 7125  
**Written By:** LT Pounds  
**Report Date:** 11-APR-2009

### Background:

Dynamic draft is the vertical displacement due to the combined effects of settlement and squat. The Field Procedures Manual requires settlement and squat to be measured at least once annually for each vessel.

### Calibration Location, Date, and Personnel:

The dynamic draft determination was performed in Lake Washington, WA.

**Personnel:** LT Pounds, PS Froelich, AST Krock-Wilson  
**Coxwain:** SS Massey  
**Location:** Lake Washington, WA  
**Date:** 12-MAR-2009; DN 071

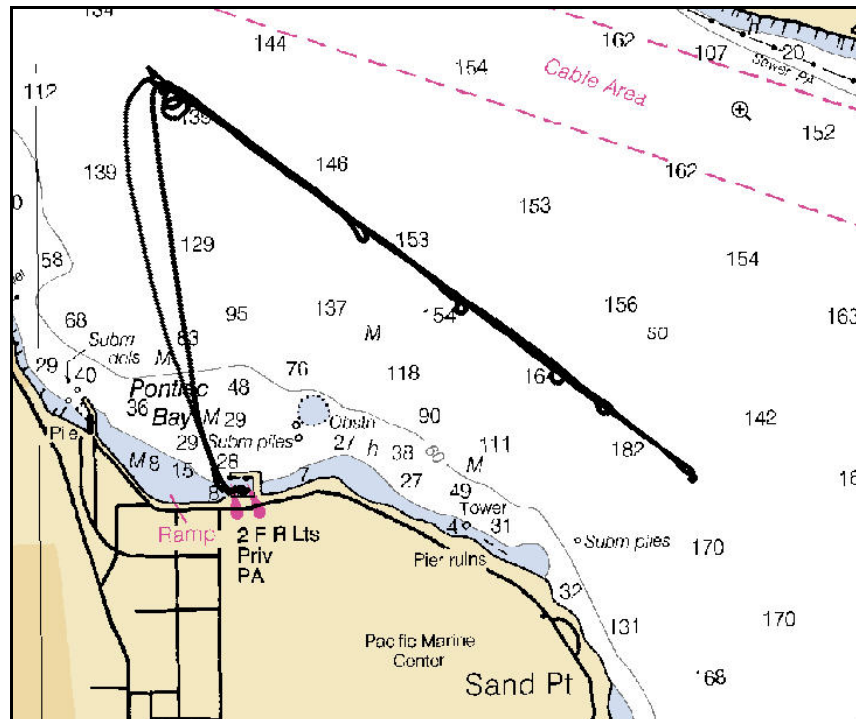


Figure 1: Location of line for the Ellipsoid Reference Method, Chart 18447

### Procedure for the Ellipsoidal Referenced Method:

The Ellipsoidally Referenced Dynamic Draft Measurement (ERDDM) methodology is based on work by ENS Glen Rice's work, outlined in the report titled *FAIRWEATHER*

*Ellipsoidally Referenced Dynamic Draft Measurement (ERDDM\_Report.pdf)*. Unlike the discrete at speed lines used by *Fairweather*, *Rainier* used a procedure developed by PS Grant Froelich described in his report *ERDDM Experiment for RA Launch 2801 (ERDDM Experiment for RA Launch 2801.pdf)*. The launch was run on a constant heading line and speed was increased in two-knot increments from four to 10 knots at two-minute intervals during the line. A two minute rest period was placed between the runs. POSPac data recording began while alongside the pier. A GPS base station was also set up to record 1 Hz data over the tidal benchmark TIDAL located in the Building 8 parking lot adjacent to the Lake Washington test area for Single Base processing in the Applanix POSPac MMS software suite.

**Results and Final Error Estimates:**

LT Pounds compiled the results from the data following the acquisition of the POS data. The POSPac data recorded by the POS MV was imported into the POSPac MMS software suite and processed using Single Base processing. The data from the GPS base station at the TIDAL benchmark was not usable and the CORS station SEAI, operated at Sand Point, was selected as the Base Station. The resulting SBET was exported as an ASCII file, which was processed using the python processing script developed by ENS Glen Rice. The resulting dynamic draft curve and table is shown below. Values generated using this method were compared to historic values and correlated well, with the ERDDM giving a more complete dynamic draft curve.

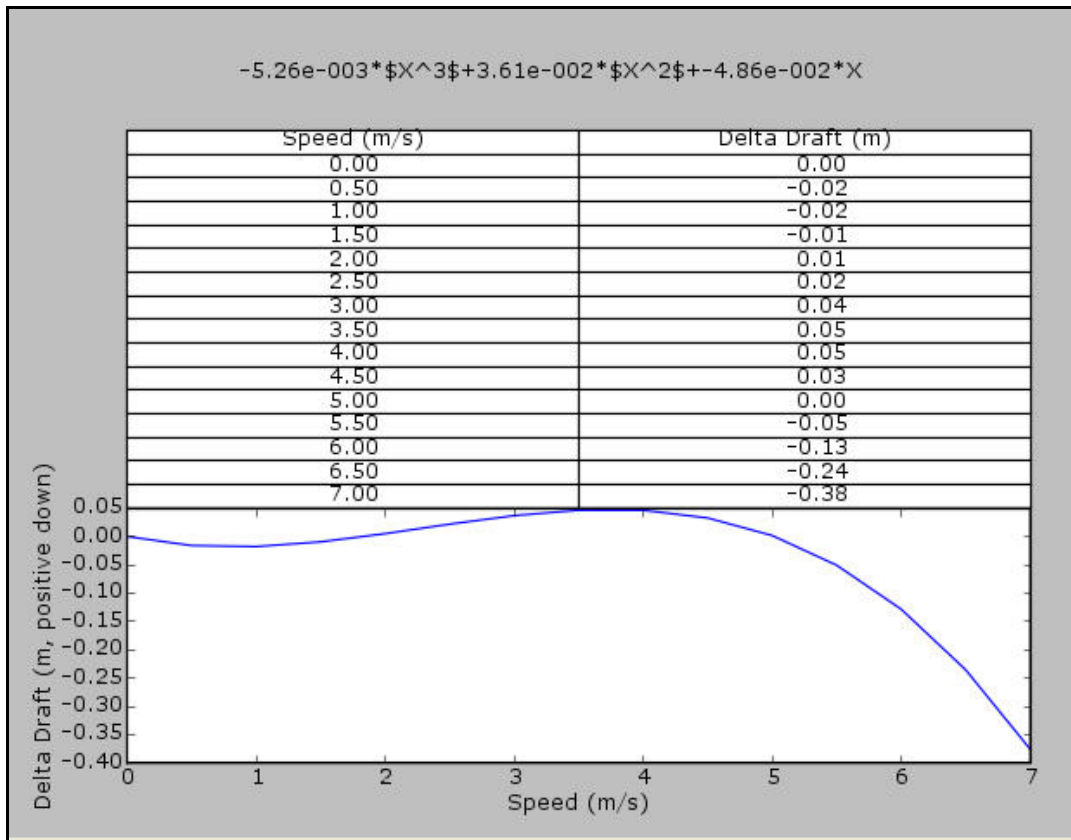


Figure 2: Dynamic Draft Curve and Values Table Generated using the ERDDM Method

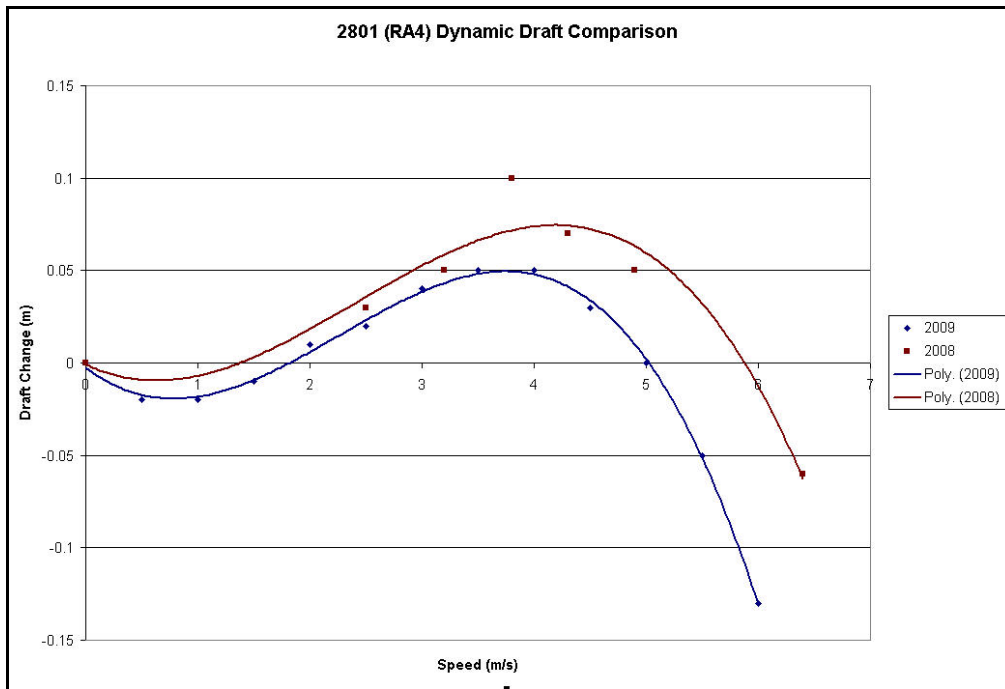


Figure 3: Dynamic Draft Curve Comparison

### Recommendations

It is the recommendation that the values generated using the ERDDM processing procedure in POSpac be used as the Dynamic Draft calibration for Vessel 2801. The data should be accepted, and the values calculated supersede prior values for the upcoming hydrographic season of 2009.



# Dynamic Draft Report

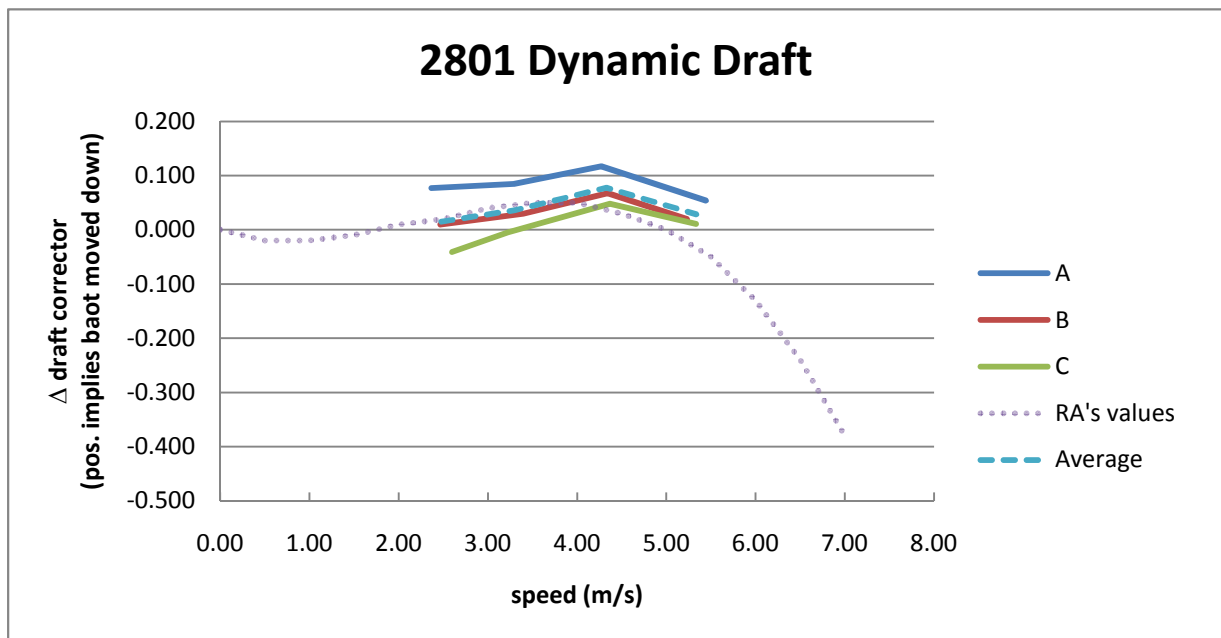
Launch 2801

Nick Forfinski

September 30, 2009

Avg. Speed	Avg. draft corrector
2.48	0.015
3.30	0.036
4.33	0.078
5.34	0.028

line	speed	$\sigma_{\text{speed}}$	depth	$\sigma_{\text{depth}}$	$\Delta$ draft	RA's values		
						(m/s)	m	
A	...2055	0.35	0.09	33.209	0.11	n/a	0	0.00
	...2019	2.37	0.09	33.132	0.09	0.077	0.5	-0.02
	...2029	3.29	0.10	33.125	0.09	0.085	1	-0.02
	...2038	4.27	0.10	33.092	0.09	0.117	1.5	-0.01
	...2045	5.44	0.10	33.155	0.09	0.054	2	0.01
B	...2057	0.62	0.11	33.846	0.06	n/a	2.5	0.02
	...2019	2.47	0.09	33.836	0.07	0.010	3	0.04
	...2029	3.40	0.07	33.816	0.07	0.030	3.5	0.05
	...2038	4.34	0.09	33.779	0.07	0.067	4	0.05
	...2045	5.23	0.10	33.826	0.07	0.020	4.5	0.03
C	...2059	0.55	0.11	40.842	0.11	n/a	5	0.00
	...2019	2.60	0.09	40.883	0.12	-0.041	5.5	-0.05
	...2029	3.22	0.08	40.847	0.11	-0.005	6	-0.13
	...2038	4.37	0.10	40.794	0.11	0.048	6.5	-0.24
	...2045	5.33	0.08	40.831	0.11	0.011	7	-0.38



## HULL 2802 (RA5) VESSEL OFFSET MEASUREMENTS CERTIFICATION REPORT 2008

---

**Vessel:** Hull 2802 (RA5) 28 ft. Aluminum Jensen Survey Launch

**Sonar / Instrument / etc.:** Reson 7125

**Written By:** CST Jacobson

**Report Date:** 4/10/08

### Background:

The following report gives a technical description of how vessel 2802 offset measurements were derived so that future surveys may accurately reproduce these results.

During the 2007-2008 winter import a brand new Jensen (2802) launch was constructed and delivered to RAINIER. Personnel from the National Geodetic Survey's Geodetic Services Division determine the spatial relationship of various sensors and reference points in relation to the POS/MV IMU. A report detailing this survey is included with the RAINIER's 2008 System Readiness package.

Two of the benchmarks positioned by NGS personnel are located on a sonar mounting bracket which was built precise dimensional standards. These two benchmarks and blueprints of the mounting bracket allowed for the determination of the exact orientation of the Reson 7125 sonar projectors once they were mounted.

### Calibration Location, Date, and Personnel:

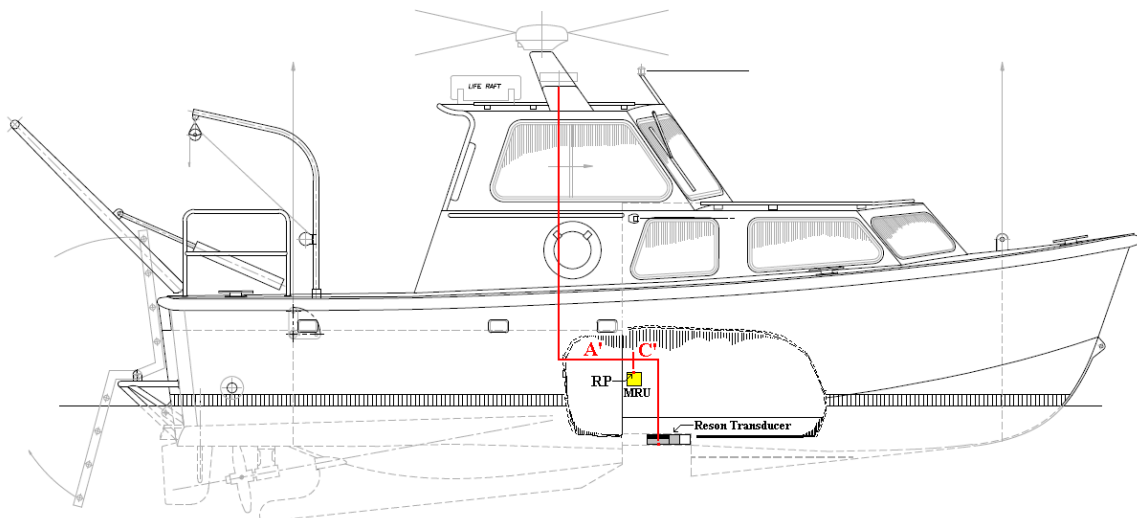
**Personnel:** CST Jacobson

**Coxwain:** N/A

**Location:** Sand point, WA

**Date:** 4/9/08 and 4/10/08

**Status:** Measurements were derived using both the NGS survey and blueprints of the sonar mounting bracket.



**Figure 1**

A' – The measurement was obtained by averaging the northing values of the port side and starboard side antenna pulled directly from the NGS survey report.

0.8820	PORT SIDE GPS ANTENNA
<u>0.8670</u>	STARBOARD SIDE GPS ANTENNA
0.8745	AVERAGE Value of antenna to RP

C' – The distance from sonar head acoustic center to RP can not be directly measured, but instead must be derived by manipulating several independent measurements. All of these dimensions (See fig. 2) were taken directly from the NGS survey, the mounting plate blueprints, or the Reson 7125 manual.

0.3420	average of distances between the two Plate RMs and the IMU
-0.0350	distance from plate RM to bolt-hole
-0.0170	bolt-hole to edge of Reson receiver
-0.1050	thickness of Reson receiver
<u>-0.1390</u>	edge of Reson receiver to Reson transmitter acoustic center
0.0460	The distance from sonar head acoustic center to RP

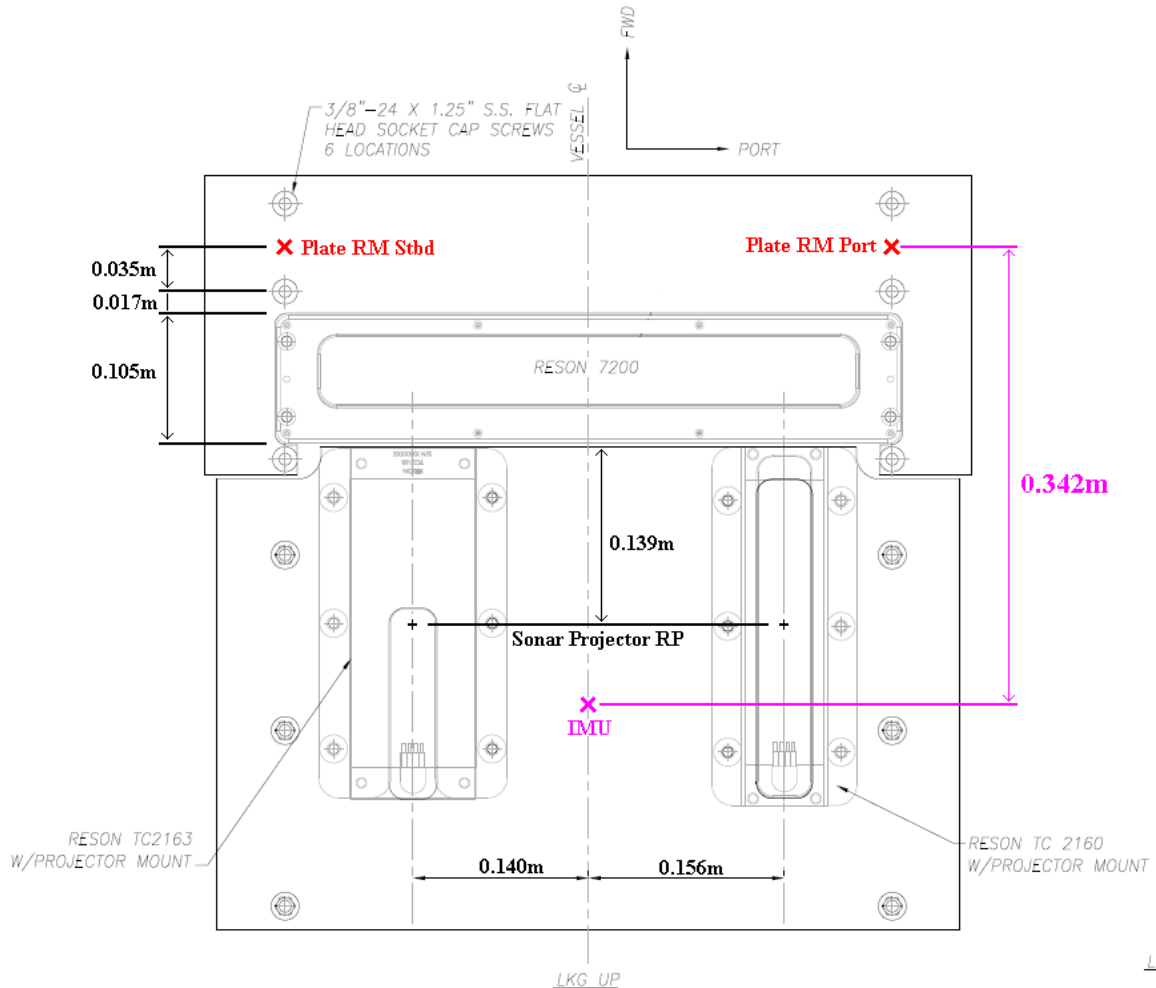
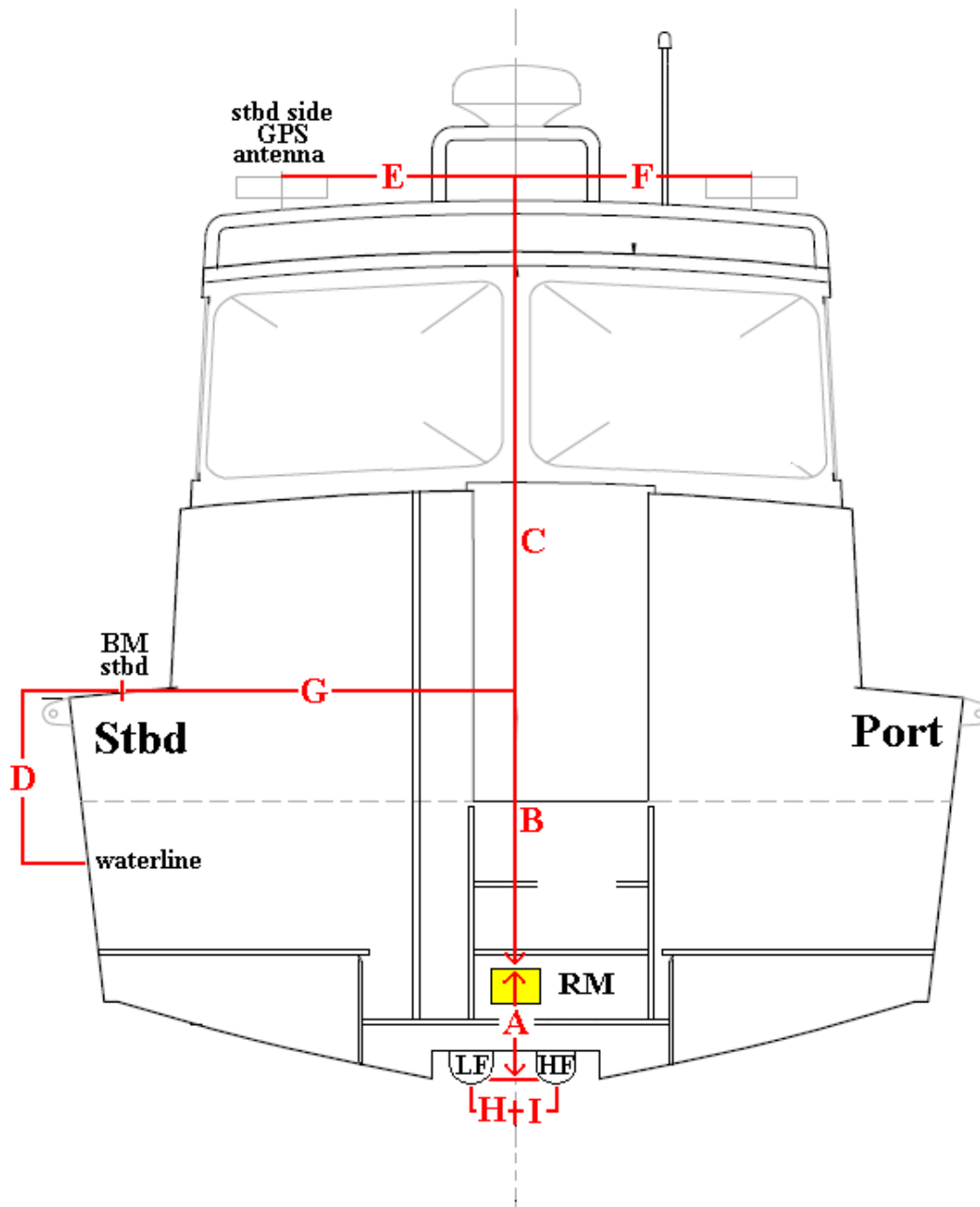


Figure 2



**Figure 3 Atwartship view of 2802 (RA-5) looking aft**

A - The distance from the waterline to the deck was determined by measuring directly from the deck to the waterline while the launch was in the water. A carpenter level was held level to the deck while a steel tape was used to measure directly to the surface of the water. Both the port and starboard measurements were taken and averaged together for a final value.

0.4780	average of distances between the two Plate RMs and the IMU
<u>-0.0260</u>	corrector from face of Reson transmitter to the acoustic center
0.4520	The distance from sonar head acoustic center to IMU

B - The measurement from the MRU to the deck benchmarks was taken directly from the NGS survey. The distance to the port and starboard BMs was the same, 1.077m.

C – This measurement was obtained by averaging the height values of the port side and starboard side antenna pulled directly from the NGS survey report.

3.4510                    PORT SIDE GPS ANTENNA  
3.4520                    STARBOARD SIDE GPS ANTENNA  
 3.4515                    AVERAGE Value of antenna to RP

D – The distance from the waterline to the deck was determined by measuring directly from the deck BM to the waterline while the launch was in the water. A carpenter level was held level to the deck while a steel tape was used to measure directly to the surface of the water. Both the port and starboard measurements were taken and averaged together for a final value.

0.9555                    Port side BM to the waterline  
0.9433                    Starboard side BM to the waterline  
 0.9494                    AVERAGE Value deck BMs to waterline

E – The measurement to the starboard GPS antenna was obtained directly from the NGS survey report, 0.493m.

F – The measurement to the port GPS antenna obtained directly from the NGS survey report, 0.495m.

G – The measurement to the port deck BM obtained directly from the NGS survey report, 1.448m.

H – The measurement to the Reson low frequency transmitter acoustic center was obtained directly from the mounting plate blueprints, 0.140m.

I – The measurement to the Reson high frequency transmitter acoustic center was obtained directly from the mounting plate blueprints, 0.156m.

**Results and Final Error Estimates:**

		Y (along-ship)	
		cm.	date measured
RP to GPS	A'	87.5	4/10/08
RP to Reson acoustic center	C'	4.6	4/10/08

NOAA SHIP RAINIER (§221)

		X (athwartship)		Z (vertical)	
		cm.	date measured	cm.	date measured
MRU to Reson acoustic center	A	n/a	n/a	45.2	4/10/08
MRU to deck BM	B	n/a	n/a	107.7	4/10/08
MRU to GPS antenna	C	n/a	n/a	345.2	4/10/08
Deck BM to waterline	D	n/a	n/a	94.9	4/10/08
Centerline to Stbd GPS	E	49.3	4/10/08	n/a	n/a
Centerline to Port GPS	F	49.5	4/10/08	n/a	n/a
Centerline to Starboard deck BM	G	144.8	4/10/08	n/a	n/a
Centerline to low freq Reson	H	14.0	4/10/08	n/a	n/a
Centerline to high freq Reson	I	15.6	4/10/08	n/a	n/a

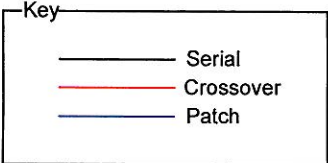
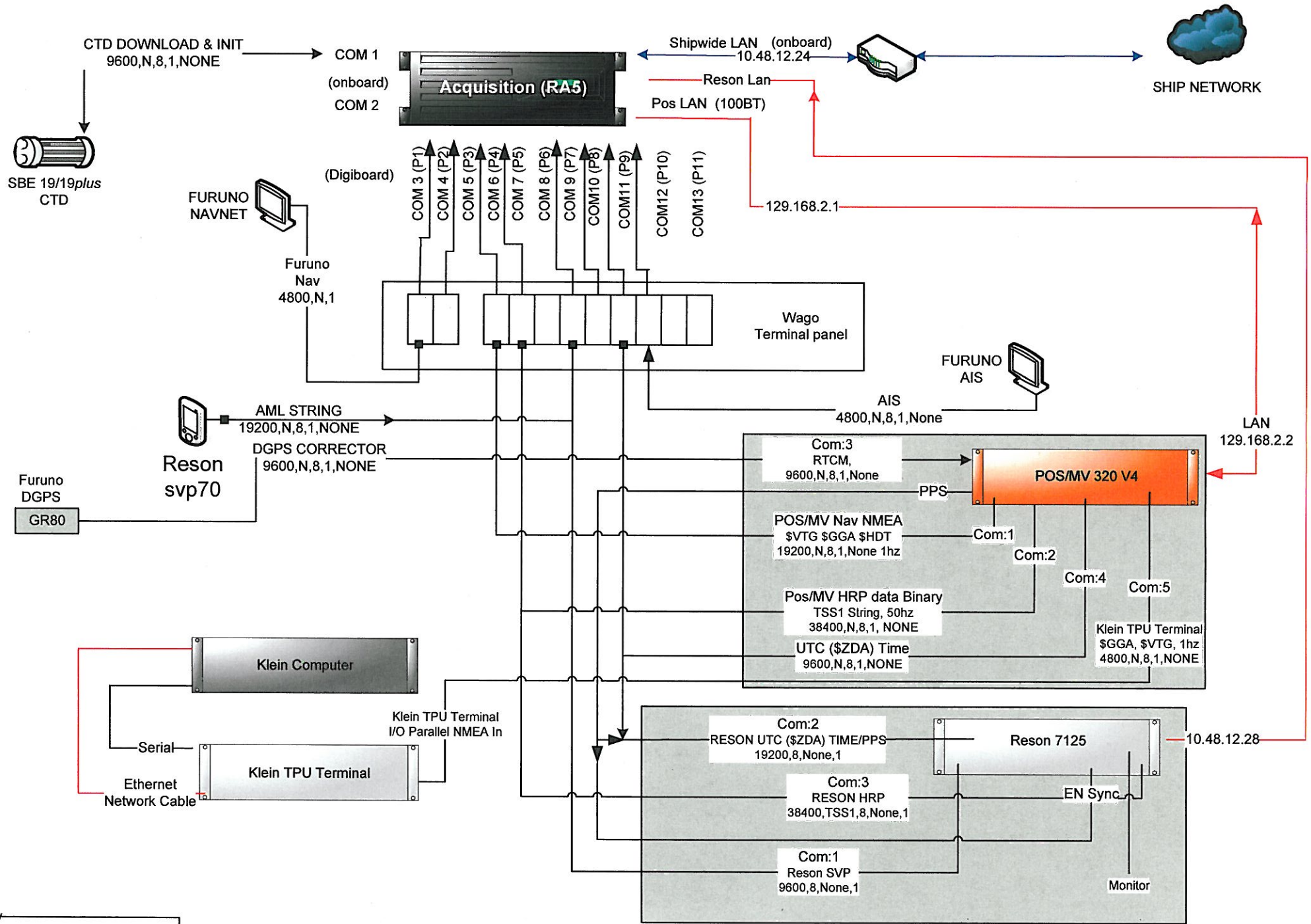
**CARIS** configuration is based on a Reference Position (RP)  
 The RP has been defined to coincide with the location of the MRU

**X** athwartship distance [+ starboard]  
**Y** along-ship distance [+ towards bow]  
**Z** vertical distance [+ into water]

<b>X</b>	RP to Reson LF transducer (equals H )	0.140	Reson LF
	RP to Reson HF transducer (equals I )	-0.156	
	MRU is RP (mounted centerline)	0.000	Reson HF
<b>Y</b>	RP to Reson LF transducer (equals C' )	0.046	Navigation
	RP to Reson HF transducer (equals C' )	0.046	Gyro
	MRU is RP	0.000	Heave Pitch Roll
<b>Z</b>	RP to Reson LF transducer (equals A )	0.452	
	RP to Reson HF transducer (equals A )	0.452	
	MRU is RP	0.000	Waterline
	MRU to waterline (equals B-D)	-0.127	

## Recommendations

Due to the combination of the NGS survey and the availability of precise measured blueprints, the offsets of launch 2802 are very precise. Errors in any of the offset measurements should be less than one centimeter. This being disclosed it is the opinion of the hydrographer that the measurements obtained and/or confirmed for this report are an accurate reflection of offset distances of vessel 2802. These offset measurements should be used to create the HVF for the 2008 field season.



**Launch 2802 Wire Diagram [RA-5]-7125**

Rev 1.0 Rev 1.1 (6-12-09)	3-20-08	Garry Streeer J. Tegeder
------------------------------	---------	-----------------------------

**FAIRWEATHER**

**Multibeam Echosounder Calibration**

2802\_7125\_200

Vessel

10/6/2009 | 279 | Glacier Bay  
Date Dn Local Area

PS Forfinski, LT Welton, PS Holmberg, LT Ringel, CST Morgan  
Calibrating Hydrographer(s)

7125-200 EA | Launch 2802 |  
MBES System MBES System Location Date of most recent EED/Factory Check

Sonar Serial Number | Processing Unit Serial Number

Hull Mounted | 4/10/2008  
Sonar Mounting Configuration Date of current offset measurement/verification

POS MV 320 v4 |  
Description of Positioning System Date of most recent positioning system calibration

**Acquisition Log**

10/6/2009 | 279 | Glacier Bay | Clear, Calm  
Date Dn Local Area Wx

Bottom Type | Approximate Water Depth

Andrews, Forfinski, Beduhn, Brooks  
Personnel on board

Beacon- 288  
Comments

2009-279\_2802  
TrueHeave filename

092791658 | 1658 | 58/57/18.1924 | 136/51/36.4992 | 41.1 |  
SV Cast #1 filename UTC Time Lat Lon Depth Ext. Depth

SV Cast #2 filename | UTC Time | Lat | Lon | Depth | Ext. Depth

SV Cast #3 filename | UTC Time | Lat | Lon | Depth | Ext. Depth





**Processing Log**

10/6/2009 | 279 | Forfinski  
 Date Dn Personnel

- Data converted --> HDCS\_Data in CARIS
- TrueHeave applied T:\Testing\_2009\PreProcess\Glacier\_Bay\_7125\_Patch and RefSurf\2802\2009-279\2009-279\_2802.C
- SVP applied T:\Testing\_2009\SVP\2802\_Patch Test\GBNP\2009-279\092791658.svp
- Tide applied Predicted  
 Zone file I:\2009\_Processed\_Data\Tide\OPR\_O351\_FA\_09\Predicted\O351FA2009CORP.zdf  
 Lines merged
- Data cleaned to remove gross fliers

**Compute correctors in this order**

1. Precise Timing      2. Pitch bias      3. Heading bias      4. Roll bias

Do not enter/apply correctors until all evaluations are complete and analyzed.

**PATCH TEST RESULTS/CORRECTORS**

Evaluators	Latency (sec)	Pitch (deg)	Roll (deg)	Yaw (deg)
Forfinski	0.00	-1.37	-0.24	-0.17
Welton	0.00	-2.26	-0.25	-1.10
Holmberg	0.00	-1.40	-0.24	-0.38
Ringel	0.00	-1.30	-0.20	-0.10
Morgan	0.00	-1.30	-0.22	-1.30
<b>Averages</b>	0.00	-1.34	-0.23	-0.22
<b>Standard Deviation</b>	0.00	0.41	0.05	0.55
<b>FINAL VALUES</b>	0.00	-1.34	-0.23	-0.22

Final Values based on averages with outliers (in grey) removed

Resulting HVF File Name 2802\_Rsn7125\_200kHz\_256bms\_2009.hvf

**Actual values used**

MRU Align StdDev gyro 0.55 Value from standard deviation of Heading offset values      MRU Align StdDev 0.15 gyro

MRU Align StdDev Roll/Pitch 0.22 Value from averaged standard deviations of pitch and roll offset values      MRU Align StdDev 0.04 Roll/Pitch

**NARRATIVE**

Forfinski: I wasn't very confident in the heading value. Locally, the values varied by a few degrees. The three individual values I came up with are based on a broad best fit.

TPU values do not include outliers, see actual values used.

- HVF Hydrographic Vessel File created or updated with current offsets  
 Name: CST Morgan      Date: 10/10/2009

**FAIRWEATHER****Multibeam Echosounder Calibration**2802\_7125\_400

Vessel

10/6/2009	279	Glacier Bay
Date	Dn	Local Area

PS Forfinski, LT Welton, PS Holmberg, LT Ringel, CST Morgan
Calibrating Hydrographer(s)

7125-400 EA	Launch 2802	
MBES System	MBES System Location	Date of most recent EED/Factory Check

Sonar Serial Number	Processing Unit Serial Number
---------------------	-------------------------------

Hull Mounted	4/10/2008
Sonar Mounting Configuration	Date of current offset measurement/verification

POS MV 320 v4	
Description of Positioning System	Date of most recent positioning system calibration

**Acquisition Log**

10/6/2009	279	Glacier Bay	Clear, Calm
Date	Dn	Local Area	Wx

Bottom Type	Approximate Water Depth
-------------	-------------------------

Andrews, Forfinski, Beduhn, Brooks
Personnel on board

Beacon- 288
Comments

2009-279_2802
TrueHeave filename

092791658	1658	58/57/18.1924	136/51/36.4992	41.1	
SV Cast #1 filename	UTC Time	Lat	Lon	Depth	Ext. Depth

SV Cast #2 filename	UTC Time	Lat	Lon	Depth	Ext. Depth
---------------------	----------	-----	-----	-------	------------

SV Cast #3 filename	UTC Time	Lat	Lon	Depth	Ext. Depth
---------------------	----------	-----	-----	-------	------------





## 2802 Dynamic Draft SYSTEM READINESS REPORT 2009

**Vessel:** RA-4; Hull # 2802  
**Sonar:** Reson 7125  
**Written By:** LT Pounds  
**Report Date:** 11-APR-2009

### Background:

Dynamic draft is the vertical displacement due to the combined effects of settlement and squat. The Field Procedures Manual requires settlement and squat to be measured at least once annually for each vessel.

### Calibration Location, Date, and Personnel:

The dynamic draft determination was performed in Lake Washington, WA.

**Personnel:** PS Froelich, ENS Shultz  
**Coxwain:** SS Massey  
**Location:** Lake Washington, WA  
**Date:** 30-MAR-2009; DN 089

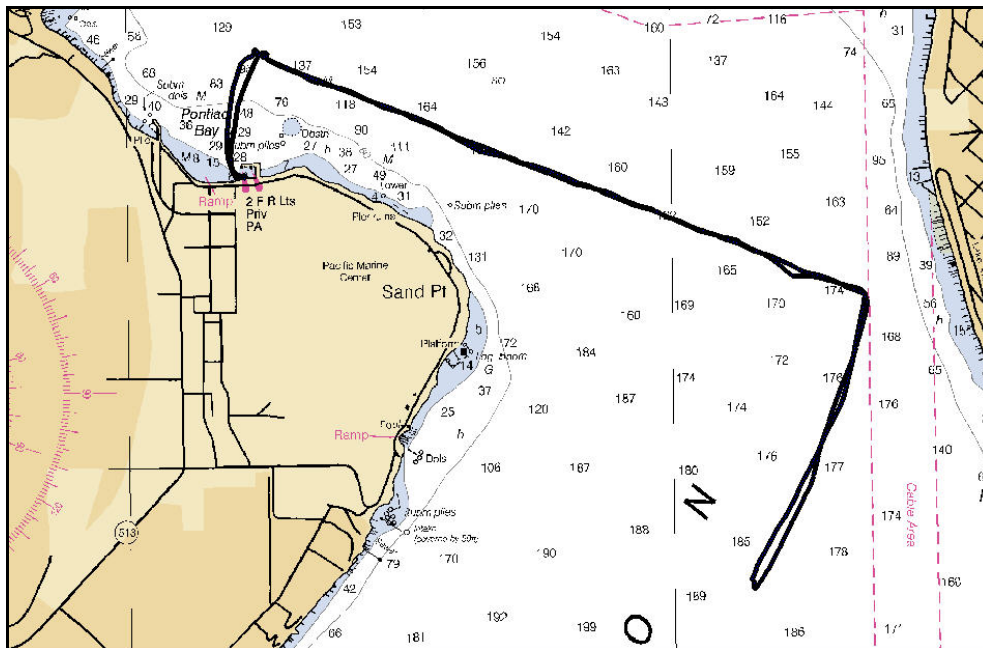


Figure 1: Location of line for the Ellipsoid Reference Method, Chart 18447

### Procedure for the Ellipsoidal Referenced Method:

The Ellipsoidally Referenced Dynamic Draft Measurement (ERDDM) methodology is based on work by ENS Glen Rice's work, outlined in the report titled *FAIRWEATHER Ellipsoidally Referenced Dynamic Draft Measurement (ERDDM\_Report.pdf)*. Unlike the discrete at speed lines used by *Fairweather*, *Rainier* used a procedure developed by

PS Grant Froelich described in his report *ERDDM Experiment for RA Launch 2801* (ERDDM Experiment for RA Launch 2801.pdf). The launch was run on a constant heading line and speed was increased in two-knot increments from four to 10 knots at two-minute intervals during the line. A two minute rest period was placed between the runs. POSPac data recording began while alongside the pier. A GPS base station was also set up to record 1 Hz data over the tidal benchmark TIDAL located in the Building 8 parking lot adjacent to the Lake Washington test area for Single Base processing in the Applanix POSPac MMS software suite.

**Results and Final Error Estimates:**

LT Pounds compiled the results from the data following the acquisition of the POS data. The POSPac data recorded by the POS MV was imported into the POSPac MMS software suite and processed using Single Base processing. The data from the GPS base station at the TIDAL benchmark was not usable and the CORS station SEAI, operated at Sand Point, was selected as the Base Station. The resulting SBET was exported as an ASCII file, which was processed using the python processing script developed by ENS Glen Rice. The resulting dynamic draft curve and table is shown below. Values generated using this method were compared to historic values and correlated well, with the ERDDM giving a more complete dynamic draft curve.

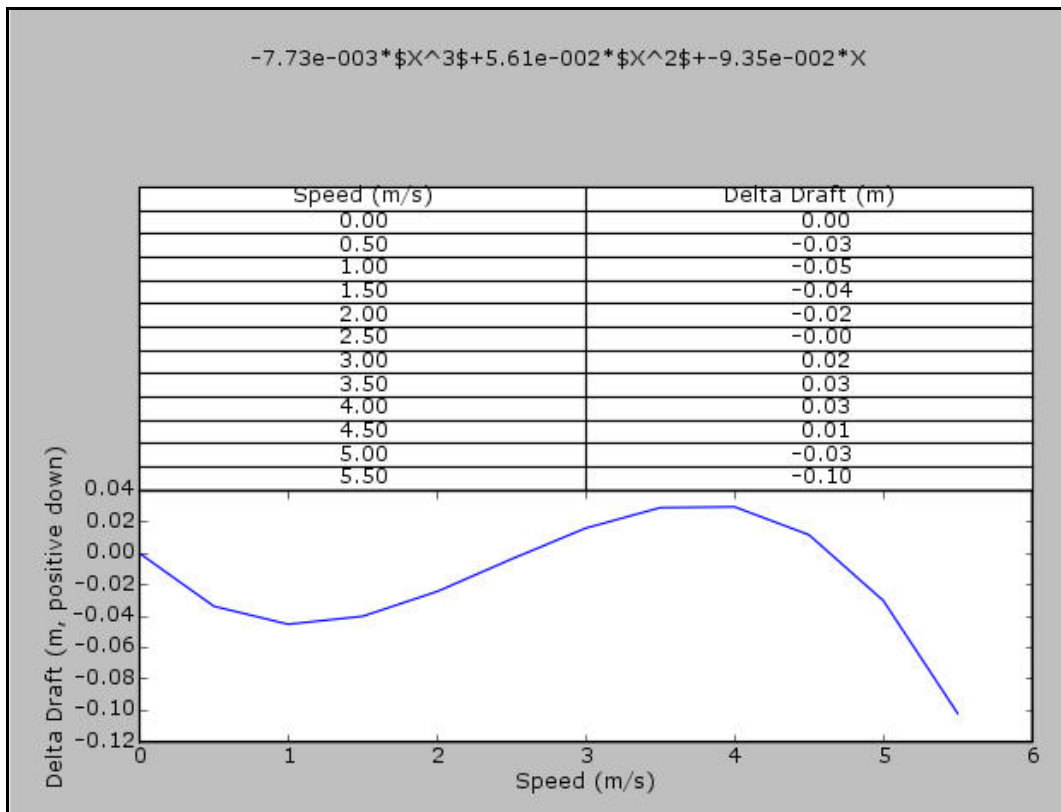


Figure 2: Dynamic Draft Curve and Values Table Generated using the ERDDM Method

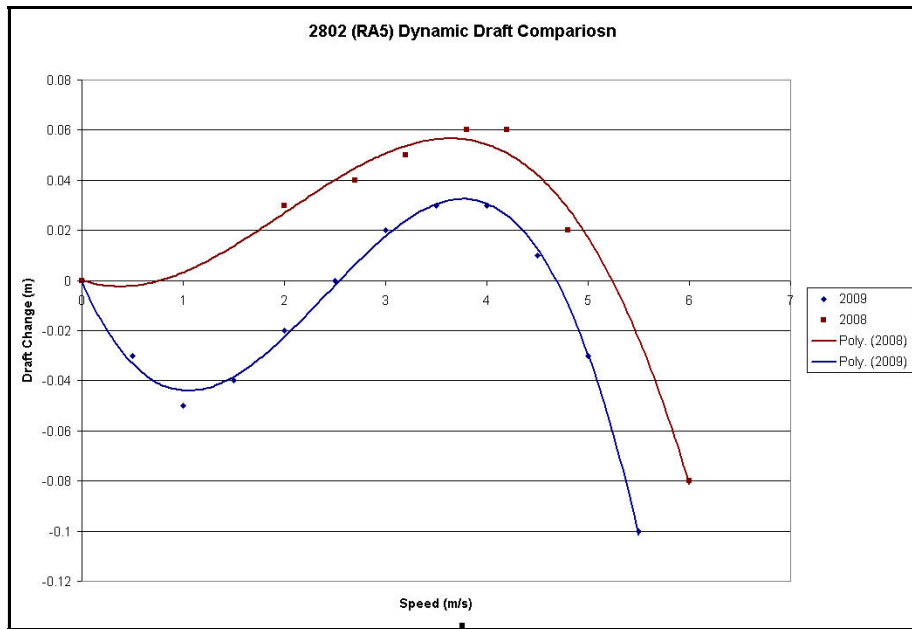


Figure 3: Dynamic Draft Curve Comparison

### Recommendations

It is the recommendation that the values generated using the ERDDM processing procedure in POSpac be used as the Dynamic Draft calibration for Vessel 2802. The data should be accepted, and the values calculated supersede prior values for the upcoming hydrographic season of 2009.



Measurement	IMU to 8111 (MRU to Trans)		Port Ant to 8111 (Nav to Trans)		Waterline to RP*		Port Ant to Stbd Ant	
Coord. Sys.	Caris		Caris		Caris			
x		2.868		2.071		n/a	Scaler Distance	1.997
y		8.252		20.144		n/a		
z		4.752		17.792		0.014		

\*Top of IMU is RP (Reference Pt)

Vessel Offsets for S220\_8111 are derived from Westlake-Survey-Report-NOAA-Fairweather-09-23-03.pdf and Fairweather\_NGS\_Report\_Feb\_2007.doc

2009 Measured Value

**Calculations**

Coord. Sys.	IMU to 8111			Port Ant to 8111			Waterline to RP*			Port Ant to Stbd Ant			
	<u>Westlake</u>			<u>NGS 2009</u>						<u>NGS 2009</u>			
IMU	easting	0.000		Top of Port	x	-11.892	IMU Base to baseline at Keel	(ft) elevation	12.856	Top of	x	-11.892	
Base	northing	0.000		Ant	y	0.797	IMU Base to baseline at Keel	(m) elevation	3.919	Port Ant	y	0.797	
	(ft/m) elevation	0.000			(m) z	13.047				(m) z	z	13.047	
	<u>Westlake</u>			Top of Ant to Phase Center			Waterline to Keel			Top of Ant to Phase Center			
8111	easting	27.072		(m) z	z	0.007	(ft) elevation	13.45	(m) z	z	0.007		
	(ft) northing	9.410		Phase Cntr	x	-11.892	(m) elevation	4.100					
	elevation	15.042		Port Ant	y	0.797			<u>NGS 2009</u>				
	<u>Westlake</u>			(m) z	z	13.040	<u>See Ship's Draft Tab</u>			Top of	x	-11.886	
8111	easting	8.252		<u>CARIS</u>	Port	x	0.797	Top of IMU to Base of IMU	(m) elevation	0.168	Stbd Ant	y	2.794
	(m) northing	2.868		Port	y	-11.892	(m) z	z	-13.040	(m) z	z	13.051	
	elevation	4.585		<u>Westlake</u>	(m) easting	8.252							
	<u>Westlake</u>			(m) northing	2.868								
Base of IMU to Top of IMU	(m) elevation	-0.168		Top of IMU to 8111	elevation	4.752							
				<u>CARIS</u>	(m) z	4.752							
				(m) easting	8.252								
				Top of IMU to 8111	elevation	4.752							
				<u>CARIS</u>	(m) x	2.868							
				Top of IMU to 8111	y	8.252							
				to 8111	z	4.752							
				<u>CARIS</u>	x	2.071							
These rows	<u>IMU to 8111</u>			<u>Port Ant to 8111</u>			<u>Waterline to RP*</u>			<u>Port Ant to Stbd Ant</u>			
<u>Westlake</u>	(m) easting	8.252		<u>CARIS</u>	x	2.071	(m) easting	N/A		Scaler Distance (m)	1.997		
unless noted	Top of IMU	northing	2.868		y	20.144	Waterline	northing	N/A				
otherwise	to 8111	elevation	4.752		(m) z	17.792	to IMU	elevation	0.014				
	Coord Sys. <u>CARIS</u>			Coord Sys. <u>CARIS</u>			Coord Sys. <u>CARIS</u>						
	x	2.868		x	2.071		x	N/A					
	y	8.252		y	20.144		y	N/A					
	z	4.752		z	17.792		z	0.014					

See Description Tab

IMU to Port Ant			IMU to Heave		
Caris		Pos/Mv	Caris		Pos/Mv
0.797		-11.892	1.866		-7.028
-11.892		0.797	-7.028		1.866
13.047		-13.047	-2.086		-2.086

Value in POSMV is top of antenna rather than the phase center to IMU.

IMU to Port Ant			IMU to Heave								
<u>NGS 2009</u>			IMU to Bulkhd (Frame) 52			IMU Base to baseline at Keel					
IMU Top (m)	x	0.000	(ft) easting	-11.638	(ft) elevation	12.856	(m) easting	-3.547	(m) elevation	3.919	
	y	0.000	(m) easting	-3.547							
	z	0.000									
<u>NGS 2009</u>			Frame 0 (FP) to Frame 52			Top of IMU to Base of IMU					
Top of Port Ant	x	-11.892	(m) easting	-27.737	(m) elevation	0.168					
(m)	y	0.797			(m) elevation	4.086					
	z	13.047									
Top of Ant to Phase Center			IMU to Frame 0 (FP)			Center of Gravity above baseline					
(m) z		0.007	(m) easting	24.190	(ft) elevation	16.37					
					(m) easting	31.218	Mean Metacentric height				
			Heave Pt* to Frame 0 (FP)			(ft) elevation	3.88				
			(ft) easting	102.42							
			(m) easting	31.218	Heave Pt* to baseline at Keel						
<u>NGS 2009</u>			IMU to Centerline			(ft) elevation	20.25				
Phase Cntr	x	-11.892	(m) northing	6.122	(m) elevation	6.172					
Port Ant	y	0.797	(m) northing	1.866							
(m)	z	13.047									
			Heave Pt* to Centerline			(*Heave Pt is Metacenter)					
			(m) northing	0	(FP is Forward Perpendicular)						

IMU to Port Ant			IMU to Heave				
<u>NGS 2009</u>	(m)	x	-11.892	(m)	easting	-7.028	
Top of IMU		y	0.797	Top of IMU	northing	1.866	
to Port Ant		z	13.047	to Heave Pt*	elevation	-2.086	
Coord. Sys.	<u>Pos/Mv</u>			Coord. Sys.	<u>Pos/Mv</u>		
		x	-11.892			x	-7.028
		y	0.797			y	1.866
		z	-13.047			z	-2.086

[see Description Tab](#)

Measurement	IMU to 8160 (MRU to Trans)	Port Ant to 8160 (Nav to Trans)	Waterline to RP*	Port Ant to Stbd Ant	IMU to Port Ant	IMU to Heave
Coord. Sys.	Caris	Caris	Caris		Caris	Caris
x	0.493	-0.304	n/a	Scaler Distance 1.997	0.797	1.866
y	7.665	19.557	n/a		-11.892	-7.028
z	4.726	17.766	0.014		13.047	-2.086

\*Top of IMU is RP (Reference Pt)

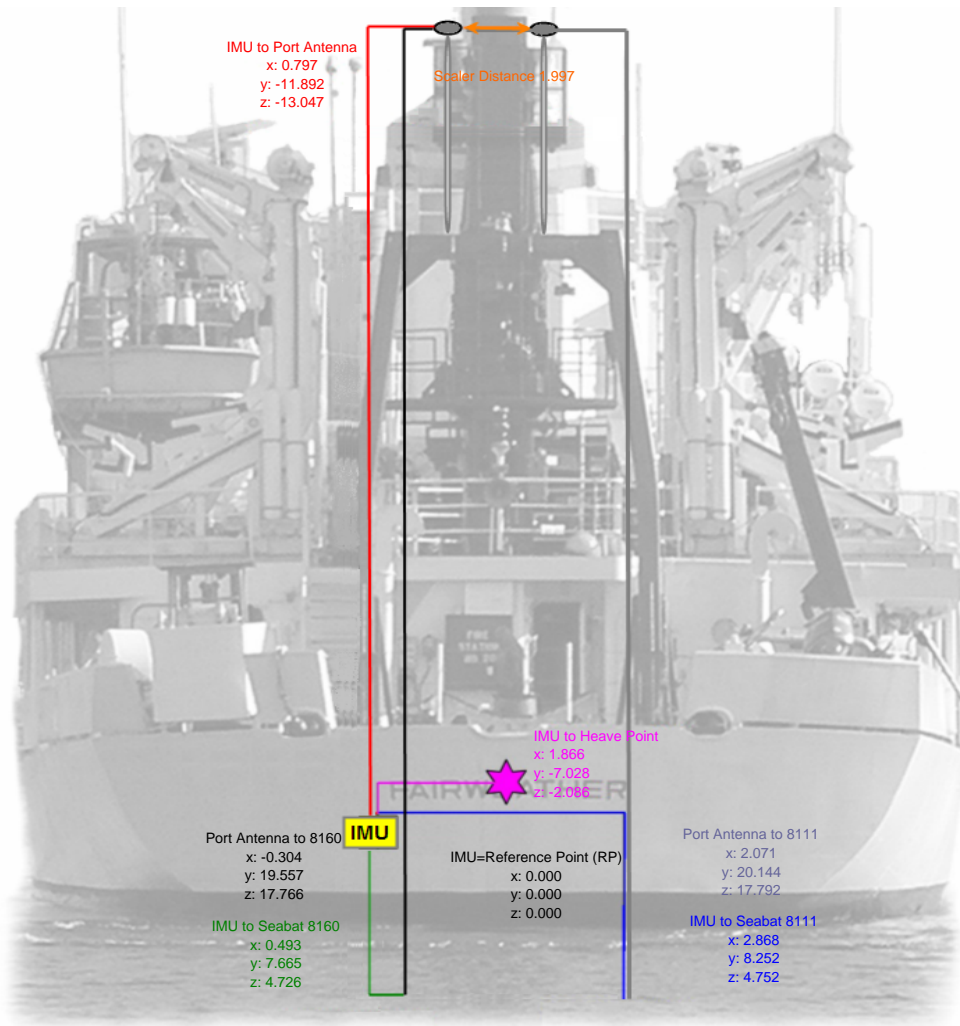
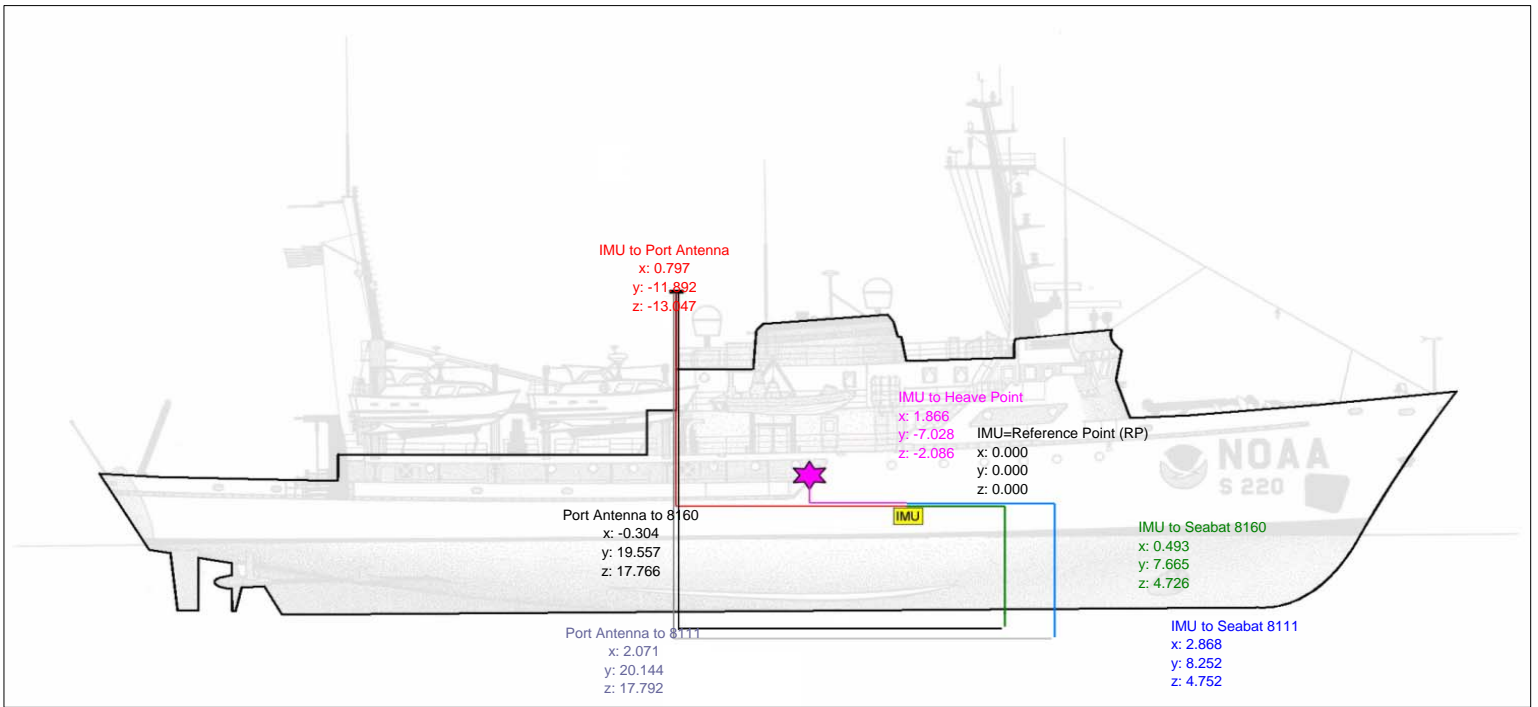
Vessel Offsets for S220\_8111 are derived from Westlake-Survey-Report-NOAA-Fairweather-09-23-03.pdf, Fairweather\_NGS\_Report\_02-07.pdf, and , FairweatherCenterlineSurvey\_03-09.pdf.

**Derivations**

Coord. Sys.	<b>IMU to 8160</b>	<b>Port Ant to 8160</b>
	<u>Westlake</u>	<u>NGS 2009</u>
IMU	easting 0.000	Top of Port x -11.892
Base	northing 0.000	Ant y 0.797
(ft/m)	elevation 0.000	(m) z 13.047
<u>Westlake</u>		Top of Ant to Phase Center
8160	easting 25.149	(m) z 0.007
(ft)	northing 1.619	Phase Cntr x -11.892
elevation	14.956	Port Ant y 0.797
<u>Westlake</u>		(m) z 13.040
8160	easting 7.665	<u>CARIS</u>
(m)	northing 0.493	Port x 0.797
elevation	4.559	Ant y -11.892
		(m) z -13.040
Base of IMU to Top of IMU		<u>Westlake</u>
(m) elevation	-0.168	(m) easting 7.665
		Top of IMU northing 0.493
		to 8160 elevation 4.726
		<u>CARIS</u>
		(m) x 0.493
		Top of IMU y 7.665
		to 8111 z 4.726
		<b>Port Ant to 8160</b>
		<u>CARIS</u>
		x -0.304
		y 19.557
		(m) z 17.766
Coord Sys	<u>Caris</u>	Coord Sys <u>Caris</u>
x	0.493	x -0.304
y	7.665	y 19.557
z	4.726	z 17.766

# Description of Offsets for FAIRWEATHER S-220

All Values Shown are in CARIS Coordinates



IMU to 8111 (MRU to Trans)		
x	y	z
2.868	8.252	4.752

The lever arms between the IMU and phase center of the 8160 transducer are taken from the Westlake report with the addition of the 0.168 m offset included for the height of the IMU.

IMU to 8160 (MRU to Trans)		
x	y	z
0.493	7.665	4.726

The lever arms between the IMU and phase center of the 8111 transducer are taken from the Westlake report with the addition of the 0.168 m offset included for the height of the IMU.

Port Ant to 8111 (Nav to Trans)		
x	y	z
2.071	20.144	17.792

This information comes from a combination of the Westlake and NGS surveys. Subtraction of the distance between Top of Antenna and the Phase Center were included in final value determination. Relative positions obtained from Port Ant to 8111 via IMU.

Port Ant to 8160 (Nav to Trans)		
x	y	z
-0.304	19.557	17.766

This information comes from a combination of the Westlake and NGS surveys. Subtraction of the distance between Top of Antenna and the Phase Center were included in final value determination. Relative positions obtained from Port Ant to 8160 via IMU.

Port Ant to Stbd Ant	
Scaler Distance	1.997

Using the NGS 2009 survey values for the antennas, a calculated vector for antenna separation was determined. The distance from Top of Antenna to Phase Center does not affect this calculation and therefore was not included.

IMU to Port Ant		
x	y	z
0.797	-11.892	13.047

This information comes directly from the NGS 2009 survey. Subtraction of the distance between Top of Antenna and the Phase Center were included in final value determination.

Waterline to RP*		
x	y	z
n/a	n/a	0.014

The height of the IMU above the keel comes from the Westlake survey value of 3.919 m plus the measured value of the top of the IMU to the base plate, to get an IMU height above the keel. The draft (waterline to keel) used for the FAIRWEATHER is based on observations. Ship's Draft spreadsheet. Differencing the value of IMU to keel and waterline to keel gives the waterline to RP distance.

IMU to Heave		
x	y	z
1.866	-7.028	-2.086

Key points on the IMU, from the Westlake survey, are its location with respect to the ship's reference frame. It is 4.087 m (3.919 m to base line + 0.168 m for IMU height above base plate) above the keel, 1.866 m port of centerline and 3.547 m forward of frame 52. This information is needed to reference the IMU to the ship's Heave Measurement Location (Heave Point). \*

IMU to Heave
From pg 3 of the Westlake Survey
<p><b>SUMMARY</b></p> <ul style="list-style-type: none"> <li>• IMU foundation plate is level to within +/-0.001 feet.</li> <li>• IMU foundation plate is located 12.856 feet above baseline established at the keel.</li> <li>• IMU is parallel to ship's centerline to within +/- 0.001 feet.</li> <li>• Location of scribed centerline intersection is 6.122 feet port of ship's centerline.</li> <li>• IMU foundation plate centerline is located 11.638' feet forward of bulkhead 52.</li> </ul>
Lynn - read through and check

\* From the Art Anderson inclination experiment the position of the metacenter was used as the position of the ship's Heave Point. (There may be a better way to determine the Heave Point, but this decision was based upon available information). The metacenter is defined by the center of buoyancy. As a vessel inclines through small angles, the center of buoyancy moves through the arc of a circle whose center is at the metacenter.

Important numbers and information determined from the Art Anderson report are the location of the metacenter and how it is positioned with respect to the vessel. The longitudinal location of the metacenter is defined as 102.42 feet (31.217 m) aft of the forward perpendicular. The height of the metacenter is 20.25 feet (6.172 m) above the keel. There is an assumption of the metacenter being on the centerline of the vessel. Similar values for the RAINIER's metacenter are 32.52 m aft of the forward perpendicular and 5.2 m above the keel. The difference in the height of the metacenter can be attributed to the difference between the FA's and RA's average draft which is 13.12 feet as opposed to approximately 14.5 feet respectively.

Referencing the metacenter (Heave Point, HP) to the IMU information requires information about the frame spacing of the vessel. From the Westlake survey, the IMU is located 3.547 m forward of frame 52. From Inclination document, the HP is 31.217 m aft of the forward perpendicular. From engineering drawings of the ship frame spacing is approximately 21 inches. The calculation for the longitudinal location of the HP with respect to frame zero, the Forward Perpendicular (FP) is as follows:

$$52 \text{ (frame)} * 21 \text{ (inches/frame)} / 12 \text{ (inches/ft)} * 0.3048 \text{ (m/ft)} - 3.547 \text{ m} = 24.190 \text{ m from frame 0.}$$

$$31.217 \text{ m (HP aft of FP)} - 24.190 \text{ m (IMU aft of FP)} = 7.027 \text{ m (HP aft of IMU)}$$

The calculation for the vertical separation between the IMU and the HP is based on the height of the metacenter being 6.172m and the height of the IMU being 4.087 m above the keel. Differencing yields the metacenter being 2.085 m above the IMU.

The calculation for the athwartship separation is based upon the assumption that the HP is on the centerline and the knowledge that the IMU is 1.866 m to port of the centerline.

## Sources

Offset values for the ship were derived from three sources. Two static offset surveys, an inclination experiment, and values measured or approximated by ship's personnel.

On September 23, 2003 an offset survey of the NOAA Ship FAIRWEATHER was conducted by:

Westlake Consultants, Incorporated  
15115 SW Sequoia Parkway, Suite 150  
Tigard, Oregon 97224  
Phone (503) 684-0652

...and the relocation of the POS M/V antenna forced a partial resurvey in Feb. 2007 by Steven Breidenbach of NGS.

These values relate the physical positions of one sensor to the next with the base plate of the IMU being the point of origin. All dimensions in the document are given in feet and decimal feet.

On July 16, 2004 an inclination experiment was conducted at MOC-P by:

Art Anderson Associates  
202 Pacific Avenue  
Bremerton, WA 98337-1932

## Calculations

The values for the required lever arms are listed in the S220\_Offsets and Measurements spreadsheet. The reference point and the IMU are identical. Difference in documentation between Westlake and FA calculations are based off of measuring up from the IMU base (Westlake's origin) and the top of the IMU. The top center of the IMU for the POS/MV is the defined origin for the POS/MV and the origin that is being used on all FAIRWEATHER vessels. The distance from the base plate to the top of the IMU is 0.168 m, a value measured by ship's complement. Conversions factor from feet to meters is 0.3048 m/ft.

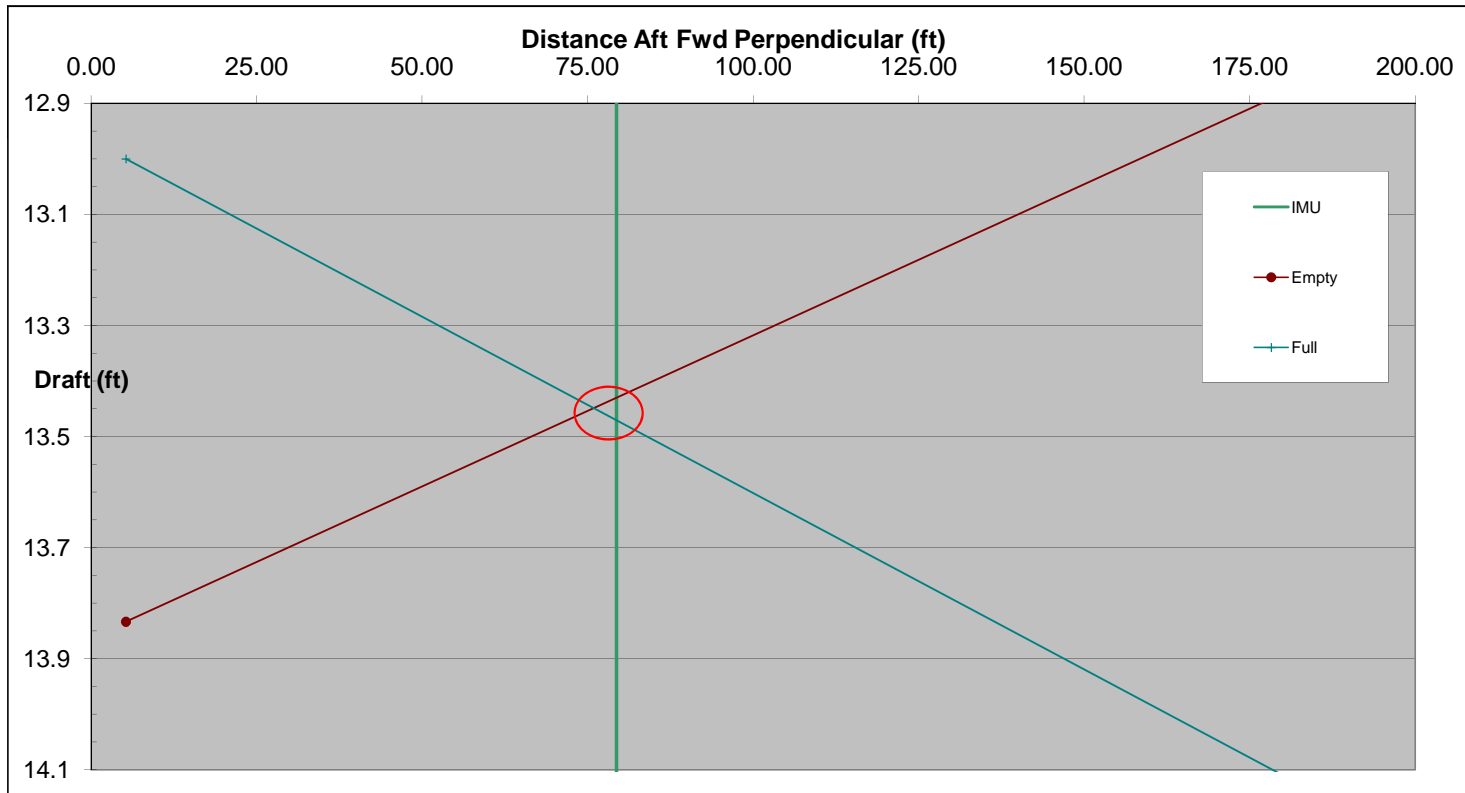
As a requirement for the TPE, the standard deviation for each position is 3 mm. This value is based upon a conversation with Elaine McDonald of Westlake and is followed up by an Email documenting that fact. The email is located at the end of this document.

## Fairweather Draft - 2009

Immediately prior to the FA field season, the draft measurements were taken prior to fueling when the takes were very empty after shipyard (Empty) . And again after fueling and once the engineers had transferred the fuel in a satisfactory manner (Full). The waterline at the IMU was then calculated based on a linear interpolation.

2009	(April)		Fwd		Aft	slope	IMU Depth (ft)	IMU Depth (m)	Min	Max
		x1	y1	x2	y2					
	Empty	5.25	13.83	189	12.83	-0.00544	13.43	4.093	12.83	14.17
	Full	5.25	13.00	189	14.17	0.00635	13.47	4.106		
		5.25		189		0.00000	0.00	0.000		
		5.25		189		0.00000	0.00	0.000		
		5.25		189		0.00000	0.00	0.000		

The IMU	x-value (ft):	79.36	Draft at IMU (ft)	13.45	4.100	AVG	Value Used in Offsets
	x-value (m):	24.19		0.029	0.009	STDEV	Value used for Waterline Loading Uncertainty



US DEPARTMENT OF COMMERCE  
NATIONAL OCEANIC & ATMOSPHERIC ADMINISTRATION  
NATIONAL OCEAN SERVICE  
NATIONAL GEODETIC SURVEY  
GEODETIC SERVICES DIVISION  
INSTRUMENTATION & METHODOLOGIES BRANCH

**NOAA SHIP FAIRWEATHER  
POS MV COMPONENTS SPATIAL RELATIONSHIP SURVEY  
FIELD REPORT**

Kendall Fancher  
March , 2009

**PRIMARY CONTACTS**

Glen Rice

NOAA 757-615-6465



# **NOAA SHIP FAIRWEATHER POS MV COMPONENTS SPATIAL RELATIONSHIP SURVEY**

## **PURPOSE**

The primary purpose of the survey was to precisely determine the spatial relationship of various components of a POS MV navigation system aboard the NOAA ship FAIRWEATHER. Additionally, various reference points (bench marks) were re-established onboard the vessel to aid in future spatial surveys aboard the boat.

## **PROJECT DETAILS**

This survey was conducted while the ship was in dry dock at the Lake Union dry dock in Seattle, WA. The weather conditions over the two days required to conduct this survey were windy, cool, with intermittent rain.

## **INSTRUMENTATION**

The Leica TC2003 total station was used to make all measurements.

Technical Data:

Standard Deviation	
Horizontal angle	0.5 seconds
Vertical angle	0.5 seconds
Distance measurement	0.2mm + 2ppm

A Leica precision prism was used as a sighting target. This prism was configured to have a zero mm offset.

## **PERSONNEL**

Kendall Fancher	NOAA/NOS/NGS/GSD/I&M BRANCH (540) 373-1243
Dennis Lokken	NOAA/NOS/NGS/GSD/I&M BRANCH (540) 373-1243

## **NOAA SHIP FAIRWEATHER POS MV COMPONENTS SPATIAL RELATIONSHIP SURVEY**

### **DEFINITION OF THE REFERENCE FRAME**

To conduct this survey a local coordinate reference frame was established where the Northing (Y) axis runs along the centerline of the ship and is positive from the IMU towards the bow of the ship. The Easting (X) axis is perpendicular to the centerline of the ship and is positive from the IMU towards the right, when looking at the ship from the stern. The Up (Z) axis is positive in an upward direction from the IMU.

### **SURVEY METHODOLOGY**

*02/15/2009*

Coordinates of 100.000N, 100.000E, and 100.000U were assumed for temporary control point 1. A distance and height difference were measured between temporary control points 1 and 3. These values were used to determine the coordinates at temporary control point 3. Temporary control points 1 and 3 were located along the top deck and on the north side of the dry dock vessel.

Temporary control point 1 was occupied and temporary control point 3 was observed for a backsight. After initialization, temporary control points 2 and 4 (located on the top deck of the dry dock vessel), H1 (located on the bottom deck of the dry dock vessel), and BOW BM were observed in both direct and reverse.

Temporary control point 2 was occupied and temporary control point 3 was observed for a backsight. After initialization, temporary control point W1 (located on the top deck of the dry dock vessel) and D1 (located inside the ship on the D deck along the port side) were observed in both direct and reverse. Temporary control point 1 was also observed and yielded an inverse check of 0.001m horizontally and 0.001m vertically.

Temporary control point 4 was occupied and control point 1 was observed for a backsight. After initialization, temporary control point 5 (located on the south side and on the top deck of the dry dock vessel) was observed in both direct and reverse.

Temporary control point 5 was occupied and control point 4 was observed for a backsight. After initialization, temporary control point D2 (located inside the ship on the D deck along the starboard side) was observed in both direct and reverse.

Temporary control point H1 was occupied and control point 1 was observed for a backsight. After initialization, temporary control point H2 (located on the bottom deck of the dry dock vessel), and USBL BM were observed in both direct and reverse.

Temporary control point H2 was occupied and temporary control point H1 was observed for a backsight. After initialization, 8111 BM and 8160 BM were observed in both direct and reverse. Temporary control point W1 was also observed and yielded an inverse check of 0.019m horizontally and 0.033m vertically.

Temporary control point D1 was occupied and temporary control point D2 was observed for a backsight. After initialization, temporary control point D3 (located in the doorway leading to the mess hall on the D deck) was observed in both direct and reverse.

Temporary control point D3 was occupied and temporary control point D1 was observed for a backsight. After initialization, temporary control point C1 (located on the C deck near the IMU) was observed in both direct and reverse. Temporary control point D2 was also observed and yielded an inverse check of 0.026m horizontally and 0.0001m vertically.

Temporary control point C1 was occupied and temporary control point D3 was observed for a backsight. After initialization, IMU, IMU BOW PORT CORNER, IMU BOW STAR CORNER, IMU STERN STAR CORNER, and IMU STERN PORT CORNER were observed in both direct and reverse.

**02/16/2009**

Temporary control point 4 was occupied and control point 1 was observed for a backsight. After initialization, temporary control point 6 (located on the south side and on the top deck of the dry dock vessel) and BOW BM were observed in both direct and reverse. Temporary control point D2 was also observed and yielded an inverse check of 0.0004m horizontally and 0.083m vertically.

Temporary control point 6 was occupied and temporary control point 4 was observed for a backsight. After initialization, TRANSOM PIVOT POINT PORT, STERN BM, POS GPS ANT RAIL BM, POS IMU ANT DECK BM, POS GPS ANT STARBOARD, and POS GPS ANT PORT were observed in both direct and reverse.

Temporary control point 3 was occupied and temporary control point 1 was observed for a backsight. After initialization, TRANSOM PIVOT POINT STARBOARD, STERN BM, POS GPS ANT STARBOARD, and POS GPS ANT PORT were observed in both direct and reverse. Temporary control point 6 was also observed and yielded an inverse check of 0.0006m horizontally and 0.001m vertically.

The reference frame was rotated using STERN BM as the point of rotation. A zero degree azimuth was used during the rotation from STERN BM to BOW BM. The reference frame was then translated to relocate the origin of the reference frame to the IMU.

**NOAA SHIP FAIRWEATHER  
POS MV COMPONENTS SPATIAL RELATIONSHIP SURVEY**

**INVERSE RESULTS**

*Inverses were computed between the determined positions of those ship benchmarks and sensor points which were determined from two separate locations. The results of these inverses are:*

<b>ID</b>	<b>Horizontal Dist.(m)</b>	<b>Elevation Diff(m)</b>
BOW BM	0.0150	0.0240
STERN BM	0.0060	0.0010
POS GPS ANT STARBOARD	0.0100	0.0001
POS GPS ANT PORT	0.0100	0.0000

**DISCUSSION**

The Fairweather was in dry dock during this survey, however, the dry dock vessel was still subject to movement due to wave action. Conducting a survey such as this while the ship is moving requires that the automatic compensators in the survey instrument be turned off. The survey is therefore conducted with all survey instrumentation set up relative to the mean movement of the related level vials. While every effort was made to make the most precise measurements possible, some additional error accumulation cannot be avoided under these type observing conditions.

The POS GPS antenna coordinates were determined to the top center of the antennas. The Z value should be corrected to the Antenna Reference Point (ARP). In order to apply this correction, the mechanical height of the antenna should be determined and subtracted from the Z value determined during this survey for both of the POS GPS antennas.

**NOAA SHIP FAIRWEATHER  
POS MV COMPONENTS SPATIAL RELATIONSHIP SURVEY**

**Coordinate Listing using IMU as the Reference Frame Origin**

<b>ID</b>	<b>X(NORTHING)m</b>	<b>Y(EASTING)m</b>	<b>Z(UP)m</b>
IMU CENTER	0.000	0.000	0.000
IMU STERN PORT CORNER	-0.071	-0.089	-0.001
IMU BOW PORT CORNER	0.070	-0.086	-0.001
IMU BOW STARBOARD CORNER	0.069	0.087	0.000
IMU STERN STARBOARD CORNER	-0.073	0.086	0.000
BOW BM	28.378	1.805	7.796
STERN BM	-40.306	1.805	2.255
USBL BM	-28.354	1.738	-4.204
8160 BM	8.407	0.395	-4.400
8111 BM	8.532	3.002	-4.666
POS GPS ANT RAIL BM	-12.011	1.785	10.381
POS IMU ANT DECK BM	-11.790	1.780	9.305
POS GPS ANT STARBOARD	-11.886	2.794	13.051
POS GPS ANT PORT	-11.892	0.797	13.047
TRANSOM PIVOT POINT STARBOARD	-39.727	3.366	2.385
TRANSOM PIVOT POINT PORT	-39.722	0.240	2.345

**NOAA SHIP FAIRWEATHER  
POS MV COMPONENTS SPATIAL RELATIONSHIP SURVEY**



IMU Reference Points

**NOAA SHIP FAIRWEATHER  
POS MV COMPONENTS SPATIAL RELATIONSHIP SURVEY**



POS GPS ANTENNAS

**NOAA SHIP FAIRWEATHER  
POS MV COMPONENTS SPATIAL RELATIONSHIP SURVEY**



**BOW CENTERLINE REFERENCE POINT**



**NOAA SHIP FAIRWEATHER  
POS MV COMPONENTS SPATIAL RELATIONSHIP SURVEY**



**CENTERLINE REFERENCE POINT ON G DECK**

**NOAA SHIP FAIRWEATHER  
POS MV COMPONENTS SPATIAL RELATIONSHIP SURVEY**



**CENTERLINE REFERENCE POINT ON RAIL AT G DECK**

**NOAA SHIP FAIRWEATHER  
POS MV COMPONENTS SPATIAL RELATIONSHIP SURVEY**



CENTERLINE STERN REFERENCE POINT

**NOAA SHIP FAIRWEATHER  
POS MV COMPONENTS SPATIAL RELATIONSHIP SURVEY**



**TRANSOM REFERENCE POINT ON PORT SIDE**



**TRANSOM REFERENCE POINT ON STARBOARD SIDE**

**NOAA SHIP FAIRWEATHER  
POS MV COMPONENTS SPATIAL RELATIONSHIP SURVEY**



**8111 REFERENCE POINT**



**NOAA SHIP FAIRWEATHER  
POS MV COMPONENTS SPATIAL RELATIONSHIP SURVEY**



**8160 REFERENCE POINT**



**NOAA SHIP FAIRWEATHER  
POS MV COMPONENTS SPATIAL RELATIONSHIP SURVEY**



**USBL REFERENCE POINT**



**US DEPARTMENT OF COMMERCE  
NATIONAL OCEANIC & ATMOSPHERIC ADMINISTRATION  
NATIONAL OCEAN SERVICE  
NATIONAL GEODETIC SURVEY  
GEODETIC SERVICES DIVISION  
INSTRUMENTATION & METHODOLOGIES BRANCH**

**NOAA SHIP FAIRWEATHER  
POS MV COMPONENTS SPATIAL RELATIONSHIP SURVEY  
FIELD REPORT**

**Steven Breidenbach  
February , 2007**



**PRIMARY CONTACTS**

LT MARK VAN WAES      NOAA (206) 526-6891



**NOAA SHIP FAIRWEATHER  
POS MV COMPONENTS SPATIAL RELATIONSHIP SURVEY**

**PURPOSE**

The primary purpose of the survey was to accurately determine the spatial relationship of various components of a POS MV navigation system aboard the NOAA ship FAIRWEATHER. Reference points were also established to determine the spatial location of differential GPS antennas, Additionally, various reference points (bench marks) were reestablished onboard the vessel to aid in future spatial surveys aboard the boat.

**PROJECT DETAILS**

This survey was conducted while the ship was docked at the USCG in Seattle, WA . The weather was cool with a steady breeze.

**INSTRUMENTATION**

The Topcon 3000LW total station was used to make all measurements.

Technical Data:

Angle Measurement	
Smallest unit in display	0.1 seconds
Standard Deviation	
Horizontal angle	1.0 seconds
Vertical angle	1.0 seconds
Distance measurement	2mm + 2ppm

A standard “peanut” prism was used as a sighting target. This prism was configured to have a zero mm offset.

**PERSONNEL**

Steve Breidenbach	NOAA/NOS/NGS/GSD/I&M BRANCH (540) 373-1243
Dennis Lokken	NOAA/NOS/NGS/GSD/I&M BRANCH (540) 373-1243

**NOAA SHIP FAIRWEATHER  
POS MV COMPONENTS SPATIAL RELATIONSHIP SURVEY**

**ESTABLISHING THE REFERENCE FRAME**

To conduct this survey a local coordinate reference frame was established where the X axis runs along the centerline of the boat and is positive from IMU towards the bow of the boat. The Y axis is perpendicular to the centerline of the boat (X axis) and is positive from IMU towards the right, when looking at the boat from the stern. The Z axis is positive in an upward direction from the IMU. In this reference frame the IMU has the following coordinates;

X = 100.000(m)

Y = 100.000(m)

Z = 100.000(m)

At the end of the survey all the coordinates were rotated to a right-handed coordinate system. The coordinates were translated to the IMU origin and the Granite Block origin.

**DISCUSSION**

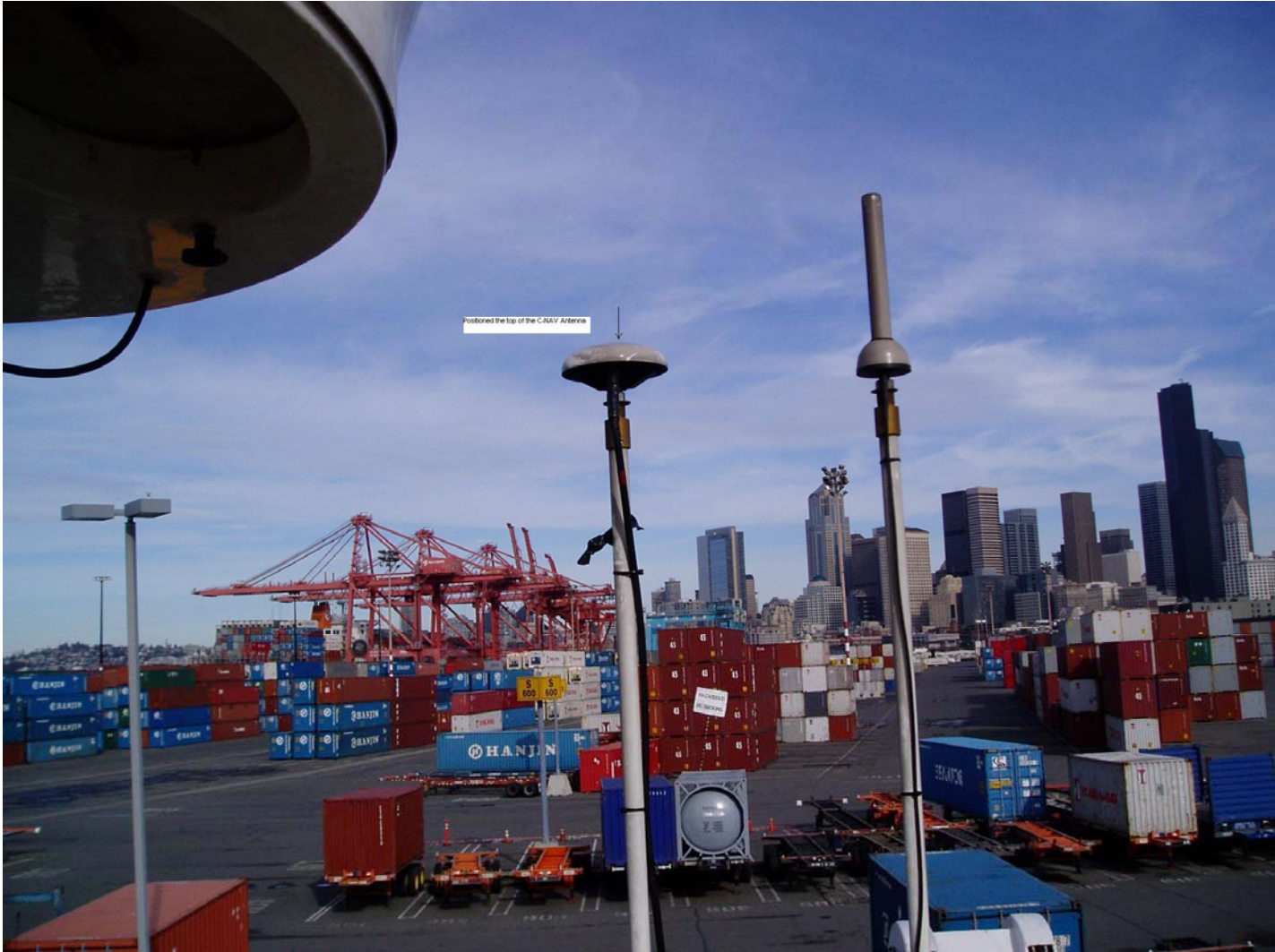
I recommend conducting the survey again, once the ship is put into dry dock. Conducting a survey such as this while the boat is in the water requires that the automatic compensators in the survey instrument be turned off. The survey is therefore conducted with all survey instrumentation set up relative to the mean movement of the related level vials. While every effort was made to make the most precise measurements possible, some additional error accumulation cannot be avoided under these type observing conditions.

The positions given for the IMU GPS antenna are to the bottom of the bolt as depicted on the photo below.



measured to flat area just under nut----->

Position of the C-NAV Antenna



**Point Summary Report**

<b>Name</b>	<b>Std Dev n (m)</b>	<b>Std Dev e (m)</b>	<b>Std Dev Hz (m)</b>	<b>Std Dev u (m)</b>
10FLOOR	0.003	0.003	0.004	0.002
11FLOOR	0.003	0.004	0.005	0.002
1CLEAT	0.004	0.018	0.019	0.002
1DECK	0.004	0.018	0.018	0.002
1FLOOR	0.000	0.000	0.000	0.000
1LOCKER	0.004	0.004	0.005	0.003
1RAIL	0.004	0.022	0.023	0.002
1WALL	0.003	0.002	0.004	0.001
1WALL3	0.003	0.003	0.004	0.002
2CLEAT	0.003	0.021	0.021	0.002
2CLEAT1	0.004	0.022	0.022	0.003
2FLOOR	0.001	0.001	0.001	0.001
2RAIL	0.004	0.022	0.022	0.002
2WALL	0.002	0.003	0.004	0.002
3ANT	0.003	0.006	0.007	0.003
3FLOOR	0.002	0.002	0.003	0.002
3WALL	0.003	0.003	0.005	0.002
4FLOOR	0.001	0.001	0.002	0.003
5FLOOR	0.002	0.004	0.005	0.001
6FLOOR	0.002	0.002	0.003	0.003
7FLOOR	0.005	0.003	0.006	0.002
8FLOOR	0.004	0.004	0.005	0.002
9FLOOR	0.002	0.013	0.013	0.003
ABOLT	0.003	0.026	0.026	0.003
ANT DECK	0.003	0.006	0.007	0.003

<b>Name</b>	<b>Std Dev n (m)</b>	<b>Std Dev e (m)</b>	<b>Std Dev Hz (m)</b>	<b>Std Dev u (m)</b>
ANT DECK BM	0.004	0.007	0.008	0.003
ANT PORT	0.003	0.007	0.008	0.003
ANT RAIL	0.004	0.006	0.007	0.003
ANT RAIL BM	0.003	0.007	0.007	0.003
ANT STAR	0.004	0.007	0.008	0.003
BOW BM	0.004	0.023	0.024	0.003
BOW BM2	0.004	0.023	0.023	0.003
BRIDGEPORT	0.005	0.011	0.012	0.003
BRIDGESTAR	0.005	0.011	0.012	0.003
BRIDGESTAR2	0.005	0.011	0.012	0.003
DOOR	0.001	0.001	0.002	0.001
GRANITE BOW	0.002	0.001	0.002	0.001
GRANITE CENTER	0.002	0.001	0.002	0.001
GRANITE PORT	0.002	0.001	0.002	0.001
GRANITE STAR	0.003	0.002	0.003	0.001
GRANITE STERN	0.002	0.001	0.002	0.001
IMU BM	0.003	0.001	0.003	0.003
IMU BOW PORT	0.002	0.001	0.002	0.001
IMU BOW STAR	0.002	0.001	0.002	0.001
IMU CENTER	0.000	0.000	0.000	0.000
IMU STERN PORT	0.002	0.001	0.002	0.001
IMU STERN STAR	0.002	0.001	0.002	0.001
LADDER	0.002	0.002	0.002	0.001
MVP BM	0.004	0.023	0.023	0.003
RAIL STAR	0.006	0.015	0.016	0.003
RAIL STAR1	0.004	0.005	0.007	0.003
RAILPORT	0.005	0.015	0.016	0.003

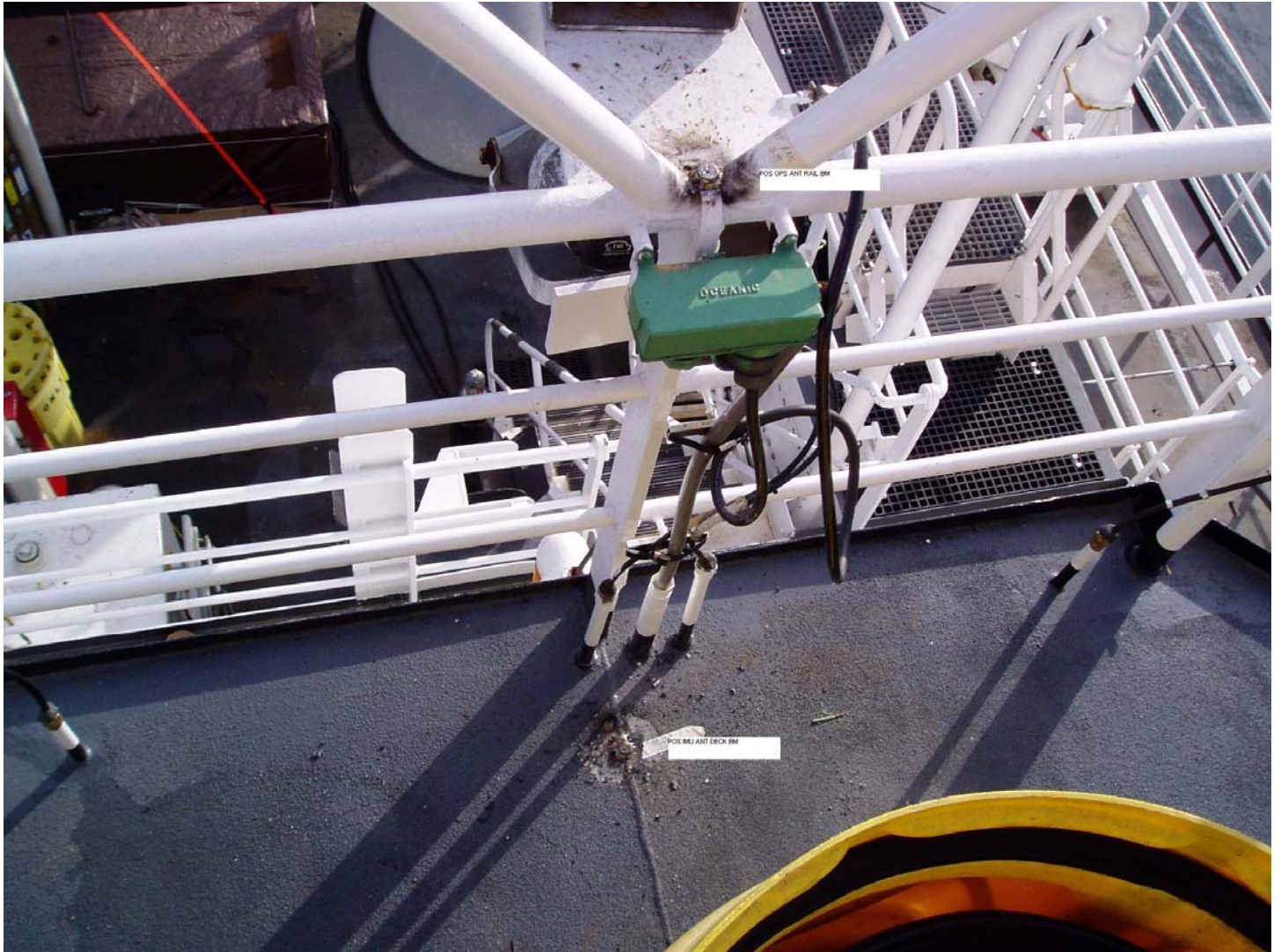
Name	Std Dev n (m)	Std Dev e (m)	Std Dev Hz (m)	Std Dev u (m)
RAILSTAR	0.005	0.015	0.016	0.003
STERN BM	0.004	0.024	0.024	0.003
STERN BM	0.003	0.024	0.024	0.002

## COORDINATES

IMU Origin			
Right-handed Coordinate System			
Name	Easting (x) meters	Northing (y) meters	Elevation (z) meters
IMU CENTER	0	0	0
IMU BOW PORT CORNER	0.073	-0.084	-0.006
IMU BOW STAR CORNER	0.071	0.088	-0.004
IMU STERN STAR CORNER	-0.068	0.089	-0.003
IMU STERN PORT CORNER	-0.065	-0.086	-0.006
GRANITE BOW	0.147	0.48	0.108
GRANITE STAR	-0.002	0.574	0.111
GRANITE STERN	-0.148	0.478	0.109
GRANITE PORT	-0.003	0.382	0.106
GRANITE CENTER	-0.002	0.477	0.108
IMU BM	0.034	-0.263	-0.496
STERN BM	-40.32	1.927	-2.184
MVP BM	-38.721	5.985	-2.018
STERN BM	-40.313	1.921	-2.181
POS GPS ANT STARBOARD	-11.917	3.171	-12.936
POS GPS ANT PORT	-11.92	1.177	-12.98
A FRAME BOLT	-43.019	1.975	-7.142
POS GPS ANT RAIL BM	-12.037	2.101	-10.376
POS IMU ANT DECK BM	-11.823	2.07	-9.301
C-NAV ANT	-10.075	4.131	-11.377
BOW BM	28.346	2.077	-7.853

<b>Granite Block Origin</b>			
<b>Right-handed Coordinate System</b>			
<b>Name</b>	<b>Easting (x) meters</b>	<b>Northing (y) meters</b>	<b>Elevation (z) meters</b>
IMU CENTER	0.002	-0.477	-0.108
IMU BOW PORT CORNER	0.075	-0.561	-0.114
IMU BOW STARBOARD CORNER	0.073	-0.39	-0.112
IMU STERN STARBOARD CORNER	-0.065	-0.388	-0.111
IMU STERN PORT CORNER	-0.063	-0.563	-0.114
GRANITE BOW	0.149	0.003	0
GRANITE STAR	0	0.097	0.003
GRANITE STERN	-0.145	0.001	0.001
GRANITE PORT	0	-0.095	-0.002
GRANITE CENTER	0	0	0
IMU BM	0.036	-0.74	-0.604
STERN BM	-40.317	1.45	-2.292
MVP BM	-38.719	5.508	-2.126
STERN BM	-40.31	1.444	-2.289
POS GPS ANT STARBOARD	-11.915	2.694	-13.044
POS GPS ANT PORT	-11.918	0.699	-13.088
A FRAME BOLT	-43.017	1.498	-7.25
POS GPS ANT RAIL BM	-12.034	1.623	-10.484
POS IMU ANT DECK BM	-11.821	1.593	-9.409
C-NAV ANT	-10.073	3.654	-11.485
BOW BM	28.349	1.6	-7.961





POS GPS RAIL BM AND POS GPS DECK BM



IMU BM



# Certificate of Accuracy

**Customer Name:** MCMaster-CARR SUPPLY CO.  
**Customer Address:** 200 AURORA IND. PARKWAY  
AURORA, OH 44202

**Customer PO#:** TA-28173060

**Date of Calibration:** 8/23/02  
**Product Description:** GRANITE SURFACE PLATE  
**Size:** 8" X 12" X 2"  
**Serial Number:** 36961  
**Accuracy:** Actual: .000075"      Allowed: .0002"  
**Repeatability:** Actual: .000055"      Allowed: .00010"  
**Grade:** B  
**Uncertainty of Measurement:** 5.2√D  
**M.O.E.:** 7.5 x 10<sup>-6</sup>


**Laboratory Conditions:** Temperature: 69 °F    Humidity: 51%

This product was inspected under environmentally controlled conditions. The electronic and optical gauging equipment used in inspecting this item has been calibrated and is traceable to the National Institute of Standards and Technology (NIST). Our calibration system is in compliance with ISO 10012-1.

### Calibration Equipment Used in the Inspection of this Product:

<u>Type of Equipment</u>	<u>ID Number</u>	<u>Instrument Uncertainty</u>	<u>NIST Traceability Number</u>	<u>Cal. Due Date</u>
Autocollimator	IP 040	±0.5 arc sec	821/259488-97	6-03
.000020 Mahr Dial I	20990	50 µin	25894-1	6-03

**Laboratory Manager Signature:**

  
Donald Schirmers, Lapping Manager  
Robert Golla, Accessories Supervisor

### REWORK / RECALIBRATION *(This section is completed for recertification orders only - accuracies upon receipt)*

**Date of Receipt:**  
**Accuracy of Incoming Product:**  
**Repeat Measurement of Incoming Product:**

*Was unable to read upon receipt due to poor condition of product*

The results on this Certificate of Accuracy apply only to the item described above. This report shall not be reproduced except in full and with the written authorization of our laboratory.

*Measurement Uncertainty is expressed at a confidence level of 95% (coverage factor k=2)*

**Procedure Number:** QP 4.10.1

# FINAL INSPECTION REPORT

Laboratory Name



1101 Prosper Drive • Box 430  
Waite Park, MN 56387  
PH: 320-251-7171 • FAX: 320-259-5073

## Final Inspection

(1) Inspection Number: 0200851

(3) Date of Receipt (rework items): \_\_\_\_\_

(2) Inspection Date: 8-23-02

(4) Repeat Reading of Received Item: \_\_\_\_\_

(5) Accuracy of Received (rework) Item: \_\_\_\_\_

(6) Customer Name: NEWSCOR-CAR

Unable to Inspect -- product in too poor of condition

(7) Serial Number: 36961

(8) P.O. Number: A-2113060

(9) Print/Part Number: \_\_\_\_\_

(10) Description of Item: 8x12x2 CB

(11) Granite Type: Impala

(12) Conditions at Time of Inspection: Temperature: 69 °F Humidity: 51

(13) Test Equipment:

Type of Equipment	Serial Number	Calibration Due Date	Uncertainty of IMTE
Autocollimator Mirror Size: <u>3"</u>			
Autocollimator <input checked="" type="checkbox"/> Repeat-o-meter <input checked="" type="checkbox"/>	<u>EP040</u>	<u>6-03</u>	<u>± 0.5 arc sec</u>
Electronic Level <input type="checkbox"/> Height Check <input type="checkbox"/>	<u>2990</u>	<u>6-03</u>	<u>50 μin</u>
Amp & Gauge Head <input type="checkbox"/> Surfometer <input type="checkbox"/>			
Penta Prism <input type="checkbox"/> Mikrokator <input type="checkbox"/>			
Other _____			

(14) Grade: B A AA N/A

(15) Overall Accuracy / Flatness (actual): .000075 (allowed): .0002

(16) Repeat Measurement (actual): .000055 (allowed): .00010 .000050 .000025 N/A

(FIM: Full Indicator Movement)

(17) Final Inspector Signature:

(18) Opinion / Interpretation (if applicable): \_\_\_\_\_

(21) Thread Size, Quantity & Location to Print: Yes \_\_\_\_\_ No \_\_\_\_\_

(22) Insert / Hole / Slot Size, Quantity & Location to Print: Yes \_\_\_\_\_ No \_\_\_\_\_

19-23 Are Not  
Applicable - No  
Inserts

(23) Inspector Signature: \_\_\_\_\_

Existing inserts are not inspected on reworks and/or calibration items.

The results of this inspection apply only to the item described above. This report shall not be reproduced, except in full, with the written approval of our laboratory. Measurement uncertainty is expressed at a confidence level of 95% (coverage factor k=2).

## Shipping

(19) Threaded Inserts: Yes \_\_\_\_\_ No \_\_\_\_\_ (20) Clean: Yes  No \_\_\_\_\_

Packaging Conforms to Company and Customer Requirements: Yes  No \_\_\_\_\_

## Tru-Stone Technologies Instructions for Care of Granite Surface Plates

- Cleaning and Moisture:** Plates shall be cleaned thoroughly and given adequate time to dry before testing for tolerance. Water based cleansers that have not dried will cause iron parts to rust if they are left in contact with the wet surface for an extended period of time. It is recommended that plates undergo drying time in a room with less than 50 percent relative humidity. Temperature and dirt have a direct correlation with measurement accuracy. Personal cleanliness will aid in eliminating one source of contamination.
- Temperature Soaking Time:** Before granite surface plates are measured for work surface flatness, the granite should remain in the calibration area until it has reached room temperature, which may require 2 to 3 days. Large plates require more soak-out time than smaller ones.
- Scratches and Nicks:** Whenever scratches and nicks appear on granite plates, the resulting rough edges should be removed with a flat granite dressing plate. Any bump that shatters the surface raises fractured material at the rim of the crater.
- Rotation of Plates:** When a specific work surface area receives prolonged usage, it is suggested that the plate and stand be rotated 180 degrees on a periodic basis to increase the wear life of the plate. The production of a contour map during calibration is particularly helpful in locating the parts of the plate that should be given the most use. This can be accomplished by requesting a long form certification when ordering the new surface plate or when the plate is being sent in for recalibration.
- Periodic Recalibration:** Periodic recalibration of granite surface plates is recommended to determine resurfacing or replacement needs. The interval between calibrations will vary with the grade of plate and the wear resistance of the granite. TRU-STONE CONFORMS TO ISO 9000 CERTIFICATION REQUIREMENTS FOR VENDORS. Frequent monitoring of the work surface by scanning it with the repeat gage is desirable. When these results differ from those marked on the replaceable sticker, you should recalibrate the plate. In addition to measuring the overall accuracy of a surface, smaller areas can be checked for localized variations often missed by the calibrating methods. Remember precision measurements are only as accurate as the measuring tools used.
- Torque on THREADED Inserts:** Do not exceed the following maximum torque values when using a torque wrench to limit distorting the work surface and pulling the insert. The following torque values are the maximum level permissible by the Federal Specification GGG-P-463c.

### PERMISSIBLE TORQUE CLAMPING ON THREDED INSERTS

<i>Thread Size</i>	<i>Torque</i>
.250 inch	7 ft. lbs.
.3125 inch	15 ft. lbs.
.375 inch	20 ft. lbs.
.500 inch	25 ft. lbs.

- Clamping Ledges on Grade AA Surface Plates:** There is danger of distorting the work surface flatness beyond tolerance when a heavy item rests on the ledge or an item is clamped to the ledge. Ledges are not only expensive, but a great cause of inaccuracy. Experimentation and research reveal that no-ledge plates retain their accuracy better than ledged plates.
- Supports:** There are working and loading conditions where the standard three point supports are not satisfactory. These cases should be individually engineered. When four or more supports are used, shims or adjusting screws are necessary for proper support. The supports could be spotted under the loading points and set to approximately equal the loading. Sometimes the work surface flatness can be improved by shifting support positions. Fulcrum, air and hydraulic supports are available. Whenever nonstandard supports are used, the surface plate shall be calibrated at the site for compliance to the flatness tolerance.

## 9. Care:

- Utilize the full surface of a plate so the wear is distributed and not concentrated in one area.
- The surface plate should not be overloaded.
- Use extreme care in moving the item being measured and the gages being used.
- Place on the surface ONLY what is required.
- Particularly avoid heavy contact with the edges.
- Don't leave metal objects on the surface longer than necessary.
- Clean the surface before and after use.

***Remember that the condition of this accurate plane  
is an integral factor in the measurement being made.***

### NOTE:

Surface plate cleaner can be purchased through your local Tru-Stone distributor or directly from Tru-Stone Technologies. Call for pricing and delivery information.

When the need for recalibration or rework of your surface plates and precision granite accessories arises, contact a Tru-Stone representative or call us directly for more details on restoring your inspection item to a "like new" condition. This service comes with new certification and plate labels.

One advantage of having your granite inspection equipment recalibrated by a manufacturer is the manufacturer's ability to take the time required to ensure the proper repeatability and overall shape of the inspection surface. Tru-Stone allows the item to normalize overnight prior to taking the final readings to indicate whether it is a good enough quality to certify and return to you.

Should you have any questions, please contact our customer service representatives at 320/251-7171 or fax us at 320/259-5073.

## **Important Notice**

Any streaks of color in the granite are not defects. These are created by the molten lava mixing with minerals prior to evolving into the granite you see today. Black streaks or spots are the result of a magnetite (black iron oxide) concentration. White streaks or spots are areas where the granite is lacking magnetite. The levels of magnetite in granite vary considerably, however the color of the granite in no way affects the functionality or quality of it.

## **Our products are UNCONDITIONALLY Guaranteed**

Please refer to the Federal Specification GGG-P-463c, which is followed by NIST (National Institute of Standards & Technology) for Granite Surface Plates.

- "3.7 Seams or Color Streaks: *Seams are cause for rejection. Color streaks have no affect on the serviceability of the granite.*"
- "4.5.8 Seams or Color Streaks: *Test for a seam is to wet the smooth surface of the granite where the color streak appears; then dry it off. If the streak remains wet or damp, it is a seam.*"

STABILITY TEST:

NOAA Ship FAIRWEATHER (16 Jul 2004 )

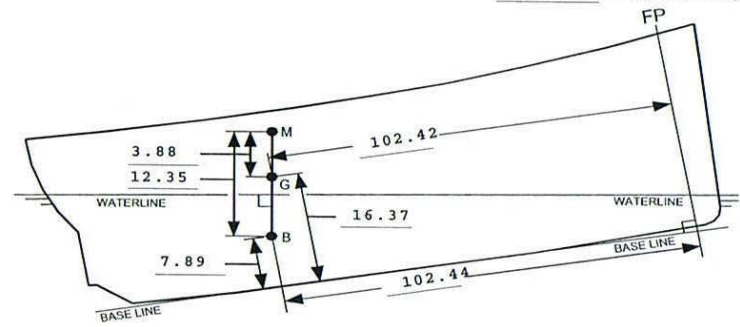
SHIP AT TIME OF STABILITY TEST--CONDITION 0

		FROM HYDROSTATIC CURVES	FROM INDEPENDENT CALCULATION
Corrected displacement		_____ tons	1638.79 tons
Mean virtual metacentric height obtained from plot of inclining moments versus tangents of angles of heel	$\frac{\text{moment}}{\text{displacement} \times \text{tangent}} = 5987.252 / 1638.790$	_____ feet	3.65 feet
Correction for free surface	$= 374.0 / 1638.790$	_____ feet	0.23 feet
Mean metacentric height G.M. =		_____ feet	3.88 feet
Transverse metacenter above base line corresponding to draft at LCF (corrected for hog or sag)		_____ feet	
Transverse metacenter above base line corrected for trim, and hog or sag		_____ feet	
C.G. above base line		_____ feet	16.37 feet (from figure)
			16.36 feet (from GHS)
Longitudinal metacenter above C.G.		_____ feet	
Moment to alter trim 1 foot, (Long GM x Δ) / L		_____ ft-tons	
Trim by stern		_____ feet	
Trimming lever = (Trim x moment to trim) / displacement		_____ feet	
Longitudinal center of buoyancy (LCB) from origin		_____ feet	
C.G. from origin		_____ feet	102.44 feet (from figure)
			102.42 feet (from GHS)

Period of complete roll \_\_\_\_\_ seconds

Apparent radius of gyration of vessel  $\alpha = \frac{T \cdot GM}{1.108}$  \_\_\_\_\_ feet

Rolling constant  $C = \frac{T \cdot GM}{B}$  \_\_\_\_\_



7/29/2004 8:05 AM

## **Definitions and Basis for Dimensions/Locations**

---

### **Northings**

Northings (Port - Starboard) are with reference to the IMU Foundation Plate centerline scribe.

Positive values are starboard of the IMU.

Negative values are port of the IMU.

*Calculated values are in italics.*

### **Eastings**

Eastings (Stern to Bow ) are with reference to the IMU Foundation Plate centerline scribe.

Positive values are forward of the IMU.

Negative values are aft of the IMU.

*Calculated values are in italics.*

### **Elevations**

Elevations are with reference to the IMU Foundation Plate centerline scribe = 0 elevation.

Positive values are below the IMU (toward the keel).

Negative values are toward the topside.

### **Dimensions**

All dimensions are in feet and decimal feet. All dimensions provided are "offsets" to IMU centerline.

### **Ship's Centerline Data**

At project initiation, control was established to define the ship's centerline as a plane running from a point on the centerline of the keel at the stern through a point on the centerline of the keel near the bow, to a point on the bow splitting the bow chock.

### **IMU Referenced Data - Procedure**

All data was originally referenced to the ship's geometry.

Following location of the IMU, data was transformed to the IMU as point of origin for

Northings, Eastings, and Elevation. All dimensions provided with reference to the IMU are "offsets."



**Ship's Centerline - Control Measurements**

(Prior to location of IMU and referencing of data to IMU as point of origin (0,0,0))

Defined by measurements at the keel centerline

	longitude	transverse	elevation
near the bow	1190.674	1000.000	135.8672
at the stern (point of origin)	1000.000	1000.000	100.0000
along the keel (approx 180' forward)	1180.121	1000.000	116.6810

**Ship's Baseline**

Defined by measurements on the keel

	longitude	transverse	elevation
at the stern (point of origin)	1000.000	1000.000	100.0000
and approx. 129' forward of stern	1129.120	999.985	100.0022

**IMU Foundation Plate**

	<i>EASTING</i>	<i>NORTHING</i>	<i>ELEVATION</i>
Horizontal alignment per scribed lines on IMU foundation plate		0.001 0.000	
Scribed lines - intersection/centerline of IMU plate	0.000	0.000	0.000
Elevation checks near four corners of IMU Foundation plate *			0.001
<i>* elevation check adjusted for target that created 10 mm offset =.03281 feet</i>			-0.001
			0.000
			-0.001

**SUMMARY**

- IMU foundation plate is level to within +/-0.001 feet.
- IMU foundation plate is located 12.856 feet above baseline established at the keel.
- IMU is parallel to ship's centerline to within +/- 0.001 feet.  
Location of scribed centerline intersection is 6.122 feet port of ship's centerline.
- IMU foundation plate centerline is located 11.638' feet forward of bulkhead 52.

**Granite Block**

	<i>EASTING</i>	<i>NORTHING</i>	<i>ELEVATION</i>	
Horizontal alignment per scribed lines		1.584 1.583		
Scribed lines - intersection/centerline of granite block	-0.003	1.583		
Elevation checks near four corners of granite block <i>* elevation check adjusted for target that created 10 mm offset = 0.03281 feet</i>			-0.217 -0.217 -0.216 -0.215	Deviation from level -0.001 -0.001 0.001 0.001

**SUMMARY**

- Granite block is level to within +/-0.001 foot of average elevation = -0.21632 feet
- Granite block is parallel to ship's centerline to within 0.001 foot  
Location is 4.54 feet to port of ship's centerline and 1.583 feet starboard of IMU.
- Granite block is aligned with IMU to within 0.003 feet longitudinally.

**Array Acoustical Centers - Referenced to IMU**

	<i>EASTING</i>	<i>NORTHING</i>	<i>ELEVATION</i>
<b>PORT ARRAY (81-60)</b>	<b>25.149</b>	<b>1.619</b>	<b>14.956</b>

**Explanation of Calculations**

Acoustic center is defined as the center of the transmitter array with the elevation = 83 mm below mounting face of array.

**Easting**

Center of array is defined by the foundation plate bolt centerlines (1/2 distance between bolts)

- 27.008 Forward edge of foundation as measured
- 0.104 Forward edge of foundation to centerline of forward bolt hole
- 1.755 Distance from bolt hole centerline to center of array

---

25.149 feet forward of IMU

**Northing**

Center of array is defined as the mid-point between the bolt holes on the foundation.

- 1.369 Port edge of foundation as measured
- + 0.078 Port edge of foundation to centerline of bolt hole - per Cascade General
- + 0.172 Distance from bolt hole centerline to array center

---

1.619 feet starboard of IMU

**Elevation**

Per Reson drawing 2148M011\_001 the elevation is 83 mm below array mounting surface

- 14.679 Array foundation elevation as measured.
- 0.005 Isolation "shim" added between foundation and array
- 0.272 83 mm below array mounting surface to acoustical center

---

14.956 feet below IMU

**Array Acoustical Centers - Referenced to IMU**

	<i>EASTING</i>	<i>NORTHING</i>	<i>ELEVATION</i>
<b>STARBOARD ARRAY (81-11)</b>	<b>27.072</b>	<b>9.41</b>	<b>15.042</b>

**Explanation of Calculations**

Acoustic center is defined as midpoint of the transmitter array in the longitudinal and transverse axes. The elevation is defined as the center of the receiving array.

**Easting**

Center of array is defined as 0.235' aft of the forward bolt centerlines on transmitter array foundation

- 28.563 Forward edge of foundation fixture plate as measured (receiving plate forward edge)
- 27.349 Forward edge of transmitter array foundation as calculated
- 0.042 Forward edge of foundation to centerline of forward bolt hole - per design
- 0.235 Distance from bolt hole centerline to center of array - per design
- 27.072 feet forward of IMU

**Northing**

Center of array is defined as the mid-point between the bolt holes on the transmitter array foundation.

- 9.410 Centerline of array foundation as measured on scribe - aft section of fixture plate
- 9.410 feet starboard of IMU

**Elevation**

Elevation is 0.401 feet above receiver array mounting surface

- 16.085 Mounting foundation fixture plate as measured.
- 15.447 Receiver foundation elevation - as calculated
- + 0.005 Isolation "shim" added between foundation and array
- 0.410 Design distance from mounting surface of array to acoustic center
- 15.042 feet below IMU

**Longitudinal Array Foundation - Port Side**

	<b>EASTING</b>	<b>NORTHING</b>	<b>ELEVATION</b>	
Horizontal alignment <i>measured</i> at port edge of array foundation		<b>1.369</b>		
		<b>1.369</b>		
Forward edge of array foundation - <i>measured</i>	<b>27.008</b>			
Horizontal alignment - <i>calculated</i> to array centerline		<b>1.619</b>		
<i>Foundation edge is 0.25 feet port of array centerline</i>		<b>1.619</b>		
Elevation checks near four corners of array foundation				deviation from level (average)
			<b>14.680</b>	0.001
			<b>14.681</b>	0.002
			<b>14.678</b>	-0.001
			<b>14.677</b>	-0.002

**SUMMARY**

- Port longitudinal array foundation average elevation is 14.679 feet.  
Variation in elevation is +0.002 to -0.002 feet.
- Port longitudinal array foundation is parallel to ship's centerline and 1.369 feet starboard of IMU.  
Calculated array centerline is 1.619 feet starboard of IMU

**Longitudinal Array Foundation - Starboard Side**

	EASTING	NORTHING	ELEVATION	
Horizontal alignment <i>measured</i> on fixture plate scribe - <i>Design location is 3.292 feet starboard of ship centerline</i>		9.410 9.406		<i>deviation from parallel</i> 0.002 -0.002
Forward edge of array foundation fixture plate - <i>measured</i>	<b>28.563</b>			
Elevation checks near four corners of array foundation "fixture plate"			<b>16.085</b> <b>16.085</b> <b>16.084</b> <b>16.085</b>	<i>deviation from average</i> 0.000 0.000 0.000 0.000
<i>Calculated locations of longitudinal and transverse array foundations</i>				
Forward edge				
Receiver (transverse)	<b>28.563</b>			
Transmitter (longitudinal)	<b>27.349</b>			
	<i>difference = 1.214</i>			
 <b>NOTE:</b> <i>On Transmitter array foundation - from forward edge to center of forward holes = 0.042'</i> <i>On Receiver array foundation distance from forward edge to center of forward holes = 0.076'</i>				
 <i>Calculated elevation of longitudinal and transverse array foundations</i>				
Receiver/Transverse Foundation			<b>15.446</b>	
Transmitter/Longitudinal Foundation			<b>15.709</b>	
	<i>difference = 0.263</i>			

**SUMMARY**

- Starboard longitudinal array foundation (measured at fixture plate) average elevation is 16.085 feet. Deviation from level (average elevation) is less than 0.001 feet.
- Starboard longitudinal array foundation averages 9.408 feet starboard of IMU. Variation from parallel is from -0.002 feet to +0.002 feet from average.
- Starboard longitudinal array foundation forward edge is 28.563 feet forward of IMU.

**Transverse Array Foundation - Port Side**

	EASTING	NORTHING	ELEVATION	
Forward Edge - Transverse array foundation - <i>measured</i>	28.343			
	28.338			
Port edge - Transverse array - <i>measured</i>		-0.181		
Centerline of array - <i>calculated</i>				
Foundation forward edge minus 0.25 feet to array centerline	28.093			
	28.088			
Port edge of foundation plus 1.806 feet to calculated array centerline		1.624		
Elevation checks near four corners of array foundation			14.679	deviation from level
			14.675	0.002
0.861 feet below baseline with 0.965 foot offset = 98.180 feet average elevation			14.675	-0.001
			14.677	-0.001
				0.001

**SUMMARY**

- Transverse array foundation average measured elevation is 14.677 feet below IMU (0.006 feet above design location).  
Deviation from level (average elevation) is 0.003 to -0.001 feet
- Transverse array foundation centerline (calculated) averages 28.090 feet forward of IMU.  
Variation from parallel to ship's centerline is from -0.003 to 0.003 feet (from average).
- Transverse array centerline is calculated to be 1.624 feet starboard of IMU.



**Transverse Array Foundation - Starboard Side**

---

NOTE: Direct Measurements were not taken to the transverse array because a single "fixture plate" covered both transmitter and receiver foundations. The data provided here is primarily "calculated".

	EASTING	NORTHING	ELEVATION
Forward edge - as measured on fixture plate			
Receiver - (transverse)	<b>28.563</b>		
as measured			
Transmitter (longitudinal)	<b>27.349</b>		
<i>difference = 1.214</i>			
 <b>NOTE:</b> On Transmitter array foundation - from forward edge to center of forward holes = 0.042' On Receiver array foundation distance from forward edge to center of forward holes = 0.076'			
Horizontal Alignment		<b>9.406</b>	
centerline scribe on fixture plate			
as measured - forward portion of plate			
(near receiver array)			
Average of measurements on fixture plate		<b>9.408</b>	
 <i>Elevation of longitudinal and transverse array foundations</i>			
Receiver/Transducer Transverse Foundation			<b>15.446</b>
Transmitter/Longitudinal Foundation			<b>15.709</b>
<i>difference = 0.263</i>			

Based on measured elevations averaging 16.085 feet across fixture plate

**SUMMARY**

- Transverse array foundation is calculated to be 15.446 feet below IMU - calculated from measured elevation of 16.085 feet. Deviation in elevation measurements across the array fixture plate is less than 0.001 feet
- Transverse array foundation forward edge (measured) is 28.563 feet forward of IMU.
- Transverse array centerline is measured to be 9.406 feet starboard of IMU.

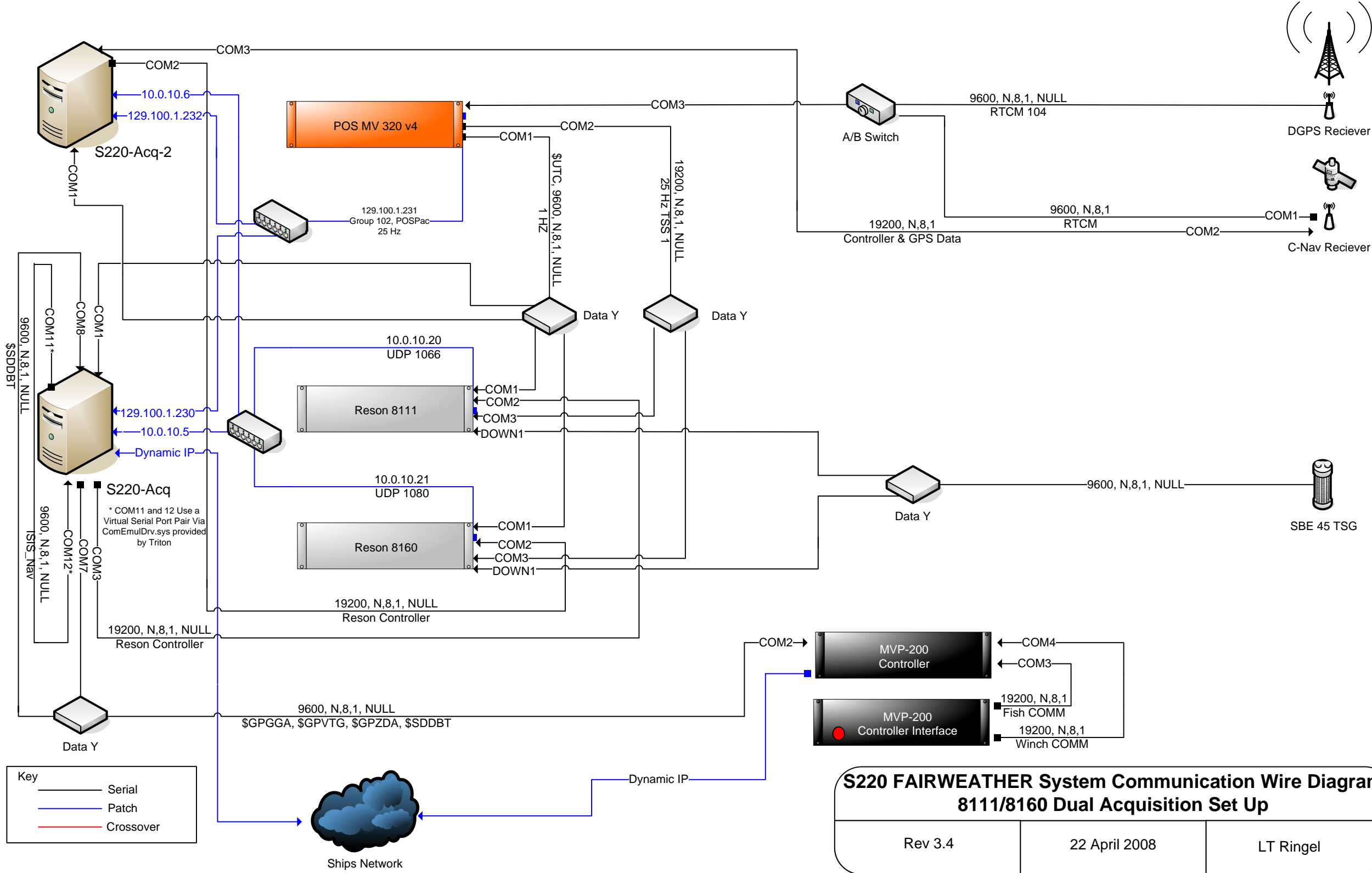
Variation from parallel of the fixture plate across entire starboard array is  $\pm 0.002$  feet (from average).

**Antennae**

	<i>EASTING</i>	<i>NORTHING</i>	<i>ELEVATION</i>
Stbd POS MV Antenna -Location	-35.866	12.925	-38.209
Port POS MV Antenna - Location	-35.739	-0.409	-38.283
Foundation Plate Stack Antenna Alignment		7.677	
Foundation Plate Stack Antenna Alignment		7.677	
Port GYRO Foundation Plate Alignment		2.411	
Port GYRO Foundation Plate Alignment		2.411	
Stbd GYRO Foundation Plate Alignment		3.866	
Stbd GYRO Foundation Plate Alignment		3.867	

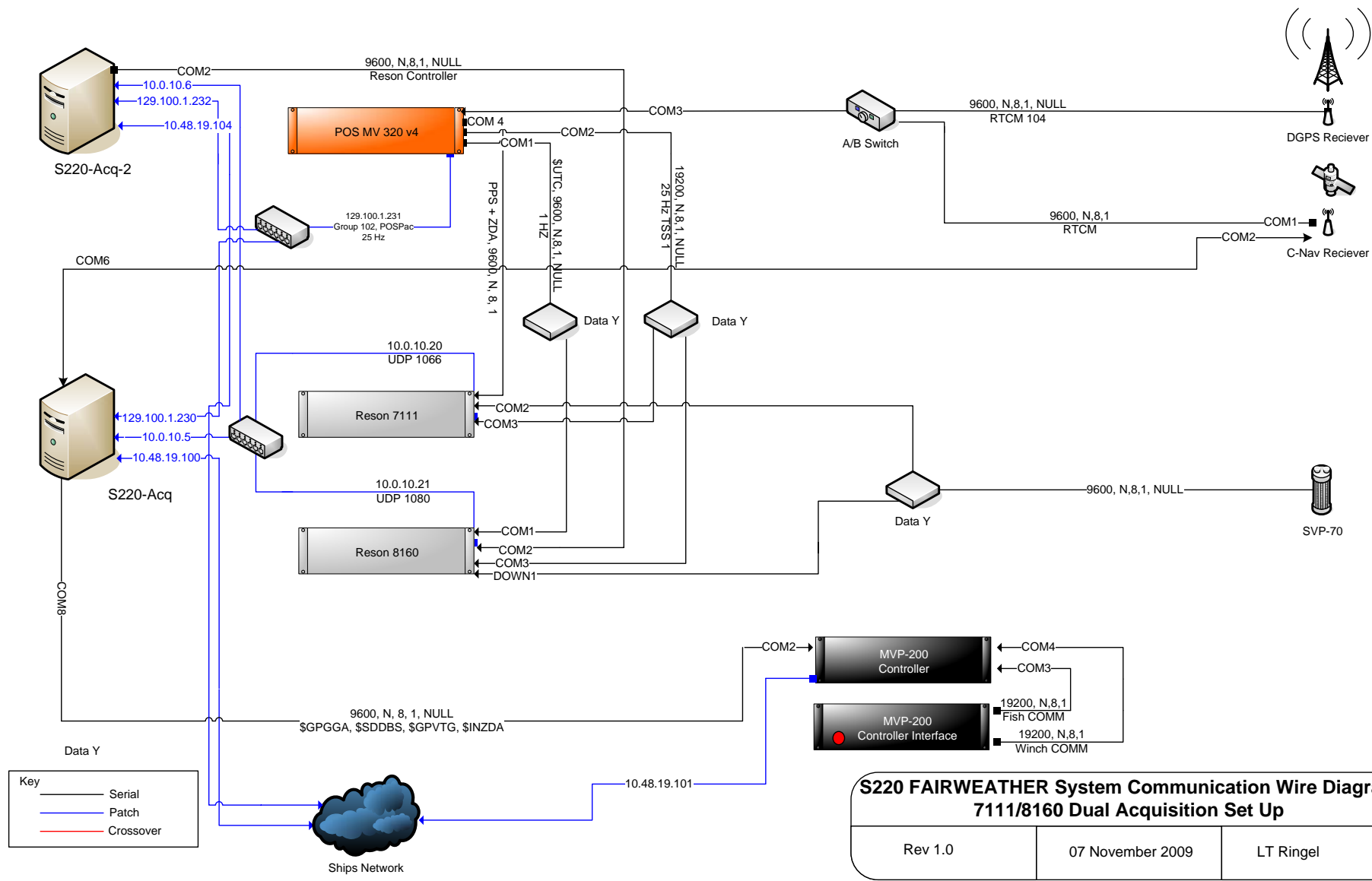
**SUMMARY**

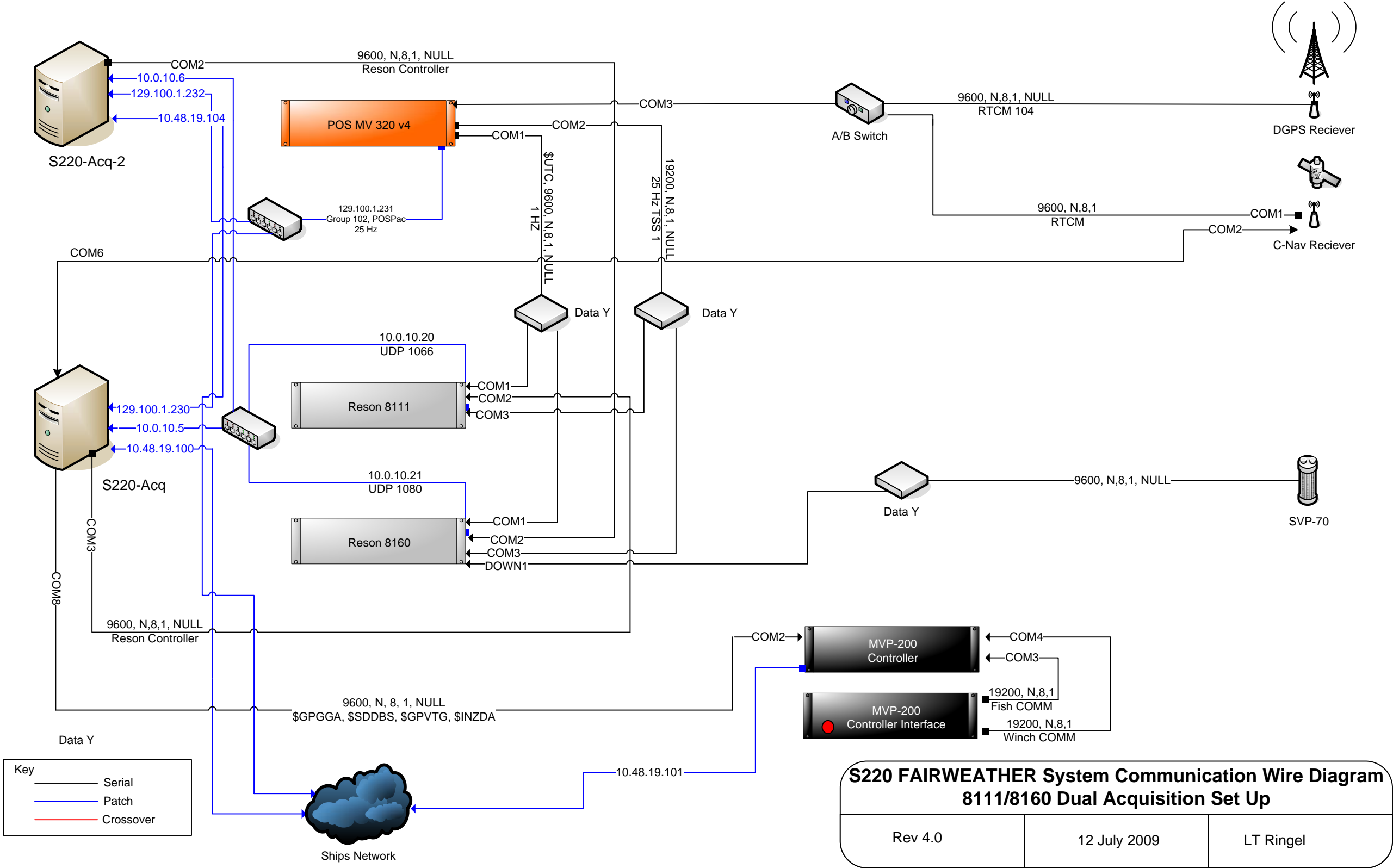
- Foundation plate stack antenna alignment is parallel to ship's centerline.
- Port GYRO Foundation Plate is aligned parallel to ship's centerline.
- Starboard GYRO Foundation Plate is aligned parallel to ship's centerline.



**S220 FAIRWEATHER System Communication Wire Diagram  
8111/8160 Dual Acquisition Set Up**

Rev 3.4	22 April 2008	LT Ringel
---------	---------------	-----------





S220-Acq-2

9600, N,8,1, NULL  
Reson Controller

POS MV 320 v4

A/B Switch

9600, N,8,1, NULL  
RTCM 104

DGPS Receiver

C-Nav Receiver

S220-Acq

Reson 8111

Reson 8160

Data Y

Data Y

Data Y

SVP-70

MVP-200  
Controller

MVP-200  
Controller Interface

**S220 FAIRWEATHER System Communication Wire Diagram  
8111/8160 Dual Acquisition Set Up**

Rev 4.0

12 July 2009

LT Ringel

Ships Network

10.0.10.6  
129.100.1.232  
10.48.19.104

129.100.1.231  
Group 102, POSPac  
25 Hz

10.0.10.20  
UDP 1066

10.0.10.21  
UDP 1080

9600, N, 8, 1, NULL  
\$GPGGA, \$SDDBS, \$GPVTG, \$INZDA

COM1  
\$UTC, 9600, N,8,1, NULL  
1 Hz

COM2  
19200, N,8,1, NULL  
25 Hz TSS 1

COM1  
COM2  
COM3

COM1  
COM2  
COM3  
DOWN1

9600, N,8,1  
RTCM

9600, N,8,1, NULL

COM6

COM8

Data Y

COM3

COM1

COM2

129.100.1.230  
10.0.10.5  
10.48.19.100

10.48.19.101

# NOAA POS/MV Calibration Report

Ship: FAIRWEATHER Vessel: S220  
Date: 4/27/2009 Dn: 117  
Personnel: Campbell, Rice  
PCS Serial # 2411 IMU Serial # 292  
IP Address: 129.100.1.231  
Port Antenna Serial # 60103854 Stbd Antenna Serial # 60125191

POS controller Version (Use Menu Help > About) 4.0.2.0

POS Version (Use Menu View > Statistics) 320 Version 4

GPS Receivers  
Primary Receiver BD950 SN:4611A66708 v.00211  
Secondary Receiver BD950 SN:4602A62806 v.00211

The screenshot shows a window titled "Statistics" with the following content:

POS Version  
MV-320,VER4,S/N2411,HW2.9-7,SW03.42-May28/07,ICD03.25,OS425B14,IMU2,PGPS13,SGPS13,RTK-0,THV-0,DPW-

GPS Receivers  
Primary Receiver  
BD950 SN:4611A66708, v.00211, channels:24  
Secondary Receiver  
BD950 SN:4602A62806, v.00211, channels:24

Statistics	
Total Hours	<b>7080.1</b>
Total Runs	<b>331</b>
Average Run (hours)	<b>21.4</b>
Longest Run (hours)	<b>549.0</b>
Current Run (hours)	<b>40.0</b>

Close

## Calibration area

Location: Central Fitz Hugh Sound, BC, Canada  
Approximate Position: \_\_\_\_\_ Lat \_\_\_\_\_  
Lon \_\_\_\_\_  
DGPS Beacon Station: Alert Bay  
Frequency: 309

## Satellite Constellation

(Use View> GPS Data)

### Primary GPS

Sketch general SV configuration or insert screen grabs

### Secondary GPS

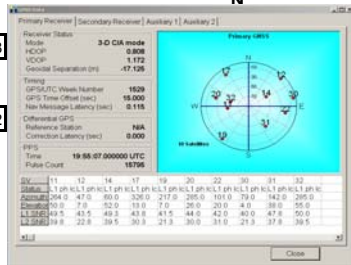
Note any differences from Primary GPS Receiver

#### HDOP

0.808

#### VDOP

1.172

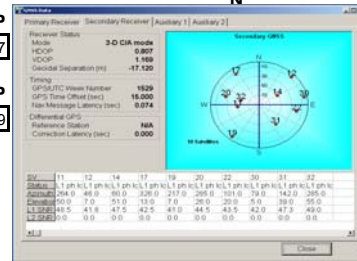


#### HDOP

0.807

#### VDOP

1.169



Satellites in use: 10  
L1 SNR > 30 35 40

Satellites in use: 10  
L1 SNR : 30 35 40

PDOP \_\_\_\_\_ (Use View> GAMS Solution)

## POS/MV Configuration Settings

### Gams Parameter Setup

(Use Settings>Installation>GAMS Installation)

Configuration Notes: Antenna separation based on 2007 survey.

## POS/MV Calibration

### Calibration Procedure:

(Refer to POS MV V3 Installation and Operation Guide, 4-25)

Start time: 19:59:38

End time: 20:34:44

Heading accuracy achieved for calibration: 0.253

### Calibration Results:

### Gams Parameter Setup

(Use Settings>Installation>GAMS Installation)

GAMS Status Online Yes  
Save Settings \_\_\_\_\_

### Calibration Notes:

### Save POS Settings on PC

(Use File > Store POS Settings on PC)

File Name: \_\_\_\_\_

## General Notes:

### The POS/MV uses a Right-Hand Orthogonal Reference System

The right-hand orthogonal system defines the following:

- The x-axis is in the fore-aft direction in the appropriate reference frame.
- The y-axis is perpendicular to the x-axis and points towards the right (starboard) side in the appropriate reference frame.
- The z-axis points downwards in the appropriate reference frame.

### The POS/MV uses a Tate-Bryant Rotation Sequence

Apply the rotation in the following order to bring the two frames of reference into complete alignment:

- a) Heading rotation - apply a right-hand screw rotation  $\theta_z$  about the z-axis to align one frame with the other.
- b) Pitch rotation - apply a right-hand screw rotation  $\theta_y$  about the once-rotated y-axis to align one frame with the other.
- c) Roll rotation - apply a right-hand screw rotation  $\theta_x$  about the twice-rotated x-axis to align one frame with the other.

## SETTINGS

### Input/Output Ports

(Use Settings > Input/Output Ports)

#### COM1

COM1 | COM2 | COM3 | COM4 | COM5

Baud Rate: 9600

Parity:  None  Even  Odd

Data Bits:  7 Bits  8 Bits

Stop Bits:  1 Bit  2 Bits

Flow Control:  None  Hardware  XON/XOFF

Output Select: NMEA

NMEA Output:  \$PASHR - TSS  \$PRDID  \$PRDID - TSS  \$INGGK  \$UTC  \$INPPS

Update Rate: 1 Hz

Talker ID: [IN]

Input Select: None

Roll Positive Sense:  Port Up  Starboard Up

Pitch Positive Sense:  Bow Up  Stern Up

Heave Positive Sense:  Heave Up  Heave Down

Buttons: Close, Apply

#### COM2

COM1 | COM2 | COM3 | COM4 | COM5

Baud Rate: 19200

Parity:  None  Even  Odd

Data Bits:  7 Bits  8 Bits

Stop Bits:  1 Bit  2 Bits

Flow Control:  None  Hardware  XON/XOFF

Output Select: Binary

Binary Output: Update Rate: 25 Hz

Formula Select: TSS1

Frame:  Sensor 1  Sensor 2

Input Select: None

Roll Positive Sense:  Port Up  Starboard Up

Pitch Positive Sense:  Bow Up  Stern Up

Heave Positive Sense:  Heave Up  Heave Down

Buttons: Close, Apply

#### COM3

COM1 | COM2 | COM3 | COM4 | COM5

Baud Rate: 9600

Parity:  None  Even  Odd

Data Bits:  7 Bits  8 Bits

Stop Bits:  1 Bit  2 Bits

Flow Control:  None  Hardware  XON/XOFF

Output Select: None

Input Select: Base GPS Input

Base 1 GPS: [None]

Input Type: [RTCM 1 or 9]

Line:  Serial  Modem

Modem Settings: [None]

Buttons: Close, Apply

#### COM4

COM1 | COM2 | COM3 | COM4 | COM5

Baud Rate: 9600

Parity:  None  Even  Odd

Data Bits:  7 Bits  8 Bits

Stop Bits:  1 Bit  2 Bits

Flow Control:  None  Hardware  XON/XOFF

Output Select: NMEA

NMEA Output:  \$GPGST  \$GPGGA  \$GPHDT  \$GPZDA  \$GPRVTG  \$PASHR

Update Rate: 1 Hz

Talker ID: [GP]

Input Select: None

Roll Positive Sense:  Port Up  Starboard Up

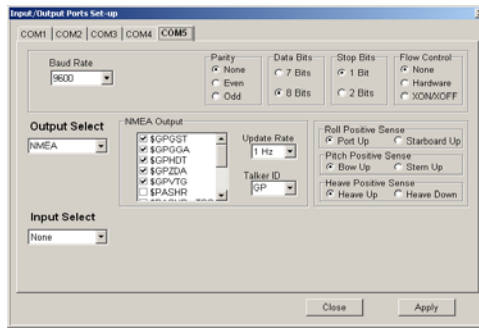
Pitch Positive Sense:  Bow Up  Stern Up

Heave Positive Sense:  Heave Up  Heave Down

Buttons: Close, Apply

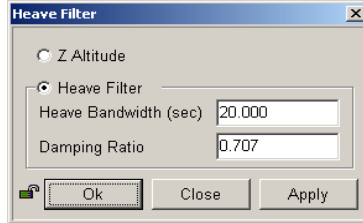


**SETTINGS Continued COM5**



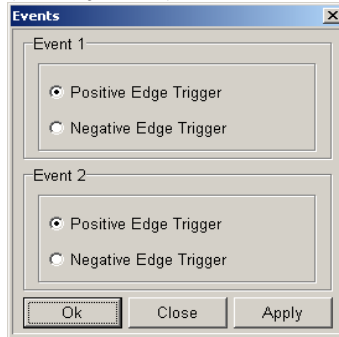
**Heave Filter**

(Use Settings > Heave)



**Events**

(Use Settings > Events)

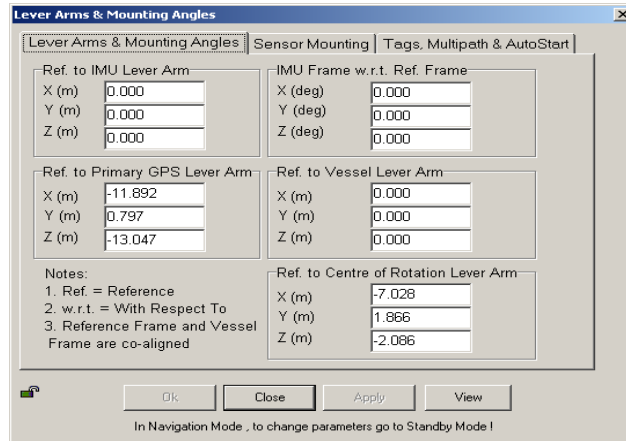


**INSTALLATION**

(Use Settings > Installation)

**Lever Arms and Mounting Angles**

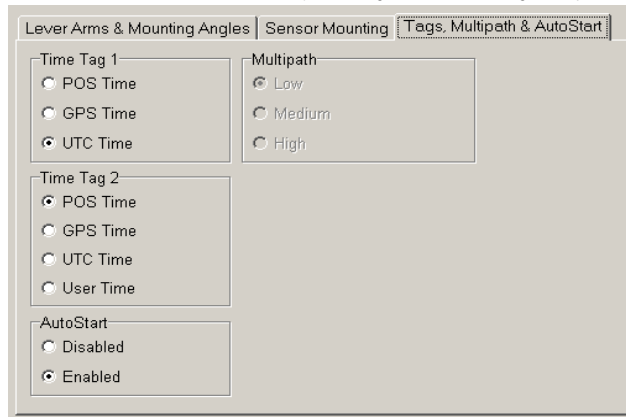
(Use Settings > Installation > Lever Arms and Offsets)



**INSTALLATION Continued**

**Tags, Multipath and Auto Start**

(Use Settings > Installation > Tags, Multipath and Auto Start)



### Sensor Mounting

(Use Settings > Installation > Sensor Mounting)

The Sensor Mounting window is divided into two main sections: 'Lever Arms & Mounting Angles' and 'Sensor Frame w.r.t. Ref. Frame'. The 'Lever Arms' section contains two columns of input fields for X, Y, and Z coordinates in meters. The 'Sensor Frame' section contains two columns of input fields for X, Y, and Z coordinates in degrees. All fields are currently set to 0.000.

Section	Parameter	Value
Lever Arms & Mounting Angles	Ref. to Aux. 1 GPS Lever Arm	
	X (m)	0.000
	Y (m)	0.000
	Z (m)	0.000
	Ref. to Aux. 2 GPS Lever Arm	
	X (m)	0.000
Sensor Frame w.r.t. Ref. Frame	Sensor 1 Frame	
	X (deg)	0.000
	Y (deg)	0.000
	Z (deg)	0.000
	Sensor 2 Frame	
	X (deg)	0.000

### User Parameter Accuracy

(Use Settings > Installation > User Accuracy)

The User Parameter Accuracy window contains five input fields for RMS Accuracy: Attitude (deg), Heading (deg), Position (m), and Velocity (m/s). The values are 0.050, 0.050, 2.000, and 0.500 respectively. There are 'Ok', 'Close', and 'Apply' buttons at the bottom.

Parameter	Value
Attitude (deg)	0.050
Heading (deg)	0.050
Position (m)	2.000
Velocity (m/s)	0.500

### Frame Control

(Use Tools > Config)

The Navigator Configuration window has four sections: 'Frame Control' with radio buttons for IMU Frame and User Frame; 'Auxiliary GPS Position' with radio buttons for Normal, Use regardless of status, and Do not use; 'Primary GPS Measurement' with radio buttons for Normal, Use regardless of status, and Do not use; and 'GAMS' with a checkbox for Disable GAMS Solution. 'Ok', 'Close', and 'Apply' buttons are at the bottom.

### GPS Receiver Configuration

(Use Settings > Installation > GPS Receiver Configuration)

#### Primary GPS Receiver

The Primary GPS Receiver configuration window shows 'GPS Output Rate' set to 1 Hz and 'GPS 1 Port' Baud Rate set to 9600. Parity is set to None, Data Bits to 8 Bits, and Stop Bits to 1 Bit. 'Auto Configuration' is set to Enabled. 'Ok', 'Close', and 'Apply' buttons are at the bottom.

Parameter	Value
GPS Output Rate	1 Hz
GPS 1 Port Baud Rate	9600
Parity	None
Data Bits	8 Bits
Stop Bits	1 Bit
Auto Configuration	Enabled

#### Secondary GPS Receiver

The Secondary GPS Receiver configuration window shows 'GPS Output Rate' set to 1 Hz and 'GPS 2 Port' Baud Rate set to 9600. Parity is set to None, Data Bits to 8 Bits, and Stop Bits to 1 Bit. 'Auto Configuration' is set to Enabled. 'Ok', 'Close', and 'Apply' buttons are at the bottom.

Parameter	Value
GPS Output Rate	1 Hz
GPS 2 Port Baud Rate	9600
Parity	None
Data Bits	8 Bits
Stop Bits	1 Bit
Auto Configuration	Enabled

# FAIRWEATHER

## Multibeam Echosounder Calibration

S220 8111

Vessel

4/28/2009 | 118 | Moira Rock  
Date Dn Local Area

Morgan, Welton, Raymond, Stuart, Ringel  
Calibrating Hydrographer(s)

Reson 8111 | Fairweather | Mar-2009  
MBES System MBES System Location Date of most recent EED/Factory Check

Unknown | 35652  
Sonar Serial Number Processing Unit Serial Number

Hull, curved transducer | 2/15/2009  
Sonar Mounting Configuration Date of current offset measurement/verification

Applanix Pos MV | 4/27/2009  
Description of Positioning System Date of most recent positioning system calibration

### Acquisition Log

4/29/2009 | 119 | Moira Rock | Ptly cloudy, cool,  
Date Dn Local Area Wx

Bottom Type | Approximate Water Depth

Personnel on board

Back time cast number BOT\_005

Comments

TrueHeave filename

BOT\_0004 | | | | | |  
SV Cast #1 filename UTC Time Lat Lon Depth Ext. Depth

BOT\_0005 | | 55\04\48.48 | 131\58\23.30 | | |  
SV Cast #2 filename UTC Time Lat Lon Depth Ext. Depth

view parallel to track, one line with induced roll (outerbeam) or same lines target or slope (nadir)  
[same direction, different speed]

**NAV TIME LATENCY**

SV Cast #	XTF Line Filename	Heading	Speed (kts)	Remarks
BOT_0005	2009_1190714	206	3.7	10m port over target
BOT_0005	2009_1190732	033	3.8	8m starboard over target
BOT_0005	2009_1190749	207	9.0	30m port over target redo:do not use for patch
BOT_0005	2009_1190800	034	8.7	7m stb over tgt
BOT_0005	2009_1190811	207	9.0	30m stb over target redo:do not use for patch
BOT_0006	2009_1190857	206	9.1	5m port over target

**PITCH**

view parallel to track, same line (at nadir) [opposite direction, same speed]

SV Cast #	XTF Line Filename	Heading	Speed (kts)	Remarks
BOT_0005	2009_1190608	207	6.5	back time cast 0605
BOT_0005	2009_1190633	033	6.5	good line held true
BOT_0005	2009_1190645	210	6.2	started to starboard, straightened smartly
BOT_0005	2009_1190658	033	7.2	15m starboard over target

**HEADING/YAW**

view parallel to track, offset lines (outerbeams) [opposite direction, same speed]

SV Cast #	XTF Line Filename	Heading	Speed (kts)	Remarks
BOT_0005	2009_1190827	031	6.5	Line 3:good line held true
BOT_0006	2009_1190911	031	6.5	Line4: good line held true
BOT_0006	2009_1190937	208	6.5	Line 3:good line held true
BOT_0006	2009_1191002	207	6.6	Line 4: good line held true

**ROLL**

view across track, same line [opposite direction, same speed]

SV Cast #	XTF Line Filename	Heading	Speed (kts)	Remarks
BOT_0004	2009_1190503	270	5.3	good line
	2009_1190519	086	5.4	Off line to Starboard 20ish meters at start
	2009_1190534	268	5.4	mostly good line, 10m off at start
	2009_1190548	091	5.7	mostly good line, 20m off Starboard at start

**Processing Log**

4/29/2009 | 119 | Stuart  
 Date Dn Personnel

Data converted --> HDCS\_Data in CARIS

TrueHeave applied PosPac\_S220\_118.005

SVP applied Moira\_Rock\_S220\_SV.svp

Tide applied zerotide.tid

Zone file \_\_\_\_\_

Lines merged

Data cleaned to remove gross fliers

**Compute correctors in this order**

1. Precise Timing      2. Pitch bias      3. Heading bias      4. Roll bias

Do not enter/apply correctors until all evaluations are complete and analyzed.

**PATCH TEST RESULTS/CORRECTORS**

Evaluators	Latency (sec)	Pitch (deg)	Roll (deg)	Yaw (deg)
B. Welton	-0.05	0.30	0.00	-0.30
A. Raymond	0.04	-0.40	0.00	-0.40
L. Stuart	-0.07	0.25	0.02	-0.70
CST Morgan	0.00	-0.20	-0.02	-0.30
FOO	0.04	-0.30	0.00	-0.20
<b>Averages</b>	-0.01	-0.07	0.00	-0.38
<b>Standard Deviation</b>	0.05	0.32    0.10	0.01	0.19    0.08
<b>FINAL VALUES</b>	0.00	-0.07	0.00	-0.38

Final Values based on CST/FOO      Average of all results

Resulting HVF File Name FA\_S220\_Reson8111\_2009.hvf

**Actual values used**  
 MRU Align StdDev 0.082 gyro  
 MRU Align StdDev Roll/Pitch 0.057

MRU Align StdDev gyro 0.19 Value from standard deviation of Heading offset values

MRU Align StdDev Roll/Pitch 0.17 Value from averaged standard deviations of pitch and roll offset values

**NARRATIVE**

Initial MRU values were too high, TPU values reassessed with outliers removed.

HVF Hydrographic Vessel File created or updated with current offsets

Name: CST Morgan

Date: 05/06/09

# FAIRWEATHER

## Multibeam Echosounder Calibration

S220 8160

Vessel

4/28/2009 | 118 | Moira Rock  
Date Dn Local Area

Morgan, Welton, Raymond, Campbell, Ringel  
Calibrating Hydrographer(s)

Reson 8160 | Fairweather - S220 | 2004  
MBES System MBES System Location Date of most recent EED/Factory Check

Unknown | 35385  
Sonar Serial Number Processing Unit Serial Number

Hull, flat faced | 2/15/2009  
Sonar Mounting Configuration Date of current offset measurement/verification

Applanix Pos MV | 4/27/2009  
Description of Positioning System Date of most recent positioning system calibration

### Acquisition Log

4/28-29/2009 | 01 | Moira Rock | Clear, cool, 2 foot chop, 10-12 kts NNW  
Date Dn Local Area Wx

|  
Bottom Type Approximate Water Depth

Personnel on board

NMEA Output was not run during SV Cast resulting in no positions, an approximate position for Cast #3 is entered below  
Comments

PosPac\_S220\_118  
TrueHeave filename

BOT\_0001 | | | | | |  
SV Cast #1 filename UTC Time Lat Lon Depth Ext. Depth

BOT\_0002 | | | | | |  
SV Cast #2 filename UTC Time Lat Lon Depth Ext. Depth

BOT\_0003 | | 55/05.9346 | 131/56.5637 | | |  
SV Cast #3 filename UTC Time Lat Lon Depth Ext. Depth

view parallel to track, one line with induced roll (outerbeam) or same lines bounded slope (nadir)  
[same direction, different speed]

**NAV TIME LATENCY**

SV Cast #	XTF Line Filename	Heading	Speed (kts)	Remarks
BOT_0001	2009_1182317	032	6.6	Also good Pitch line
	2009_1182347	033	4.4	
	2009_1182332	207	7.0	Good pitch line
	2009_1190007	207	4.3	Latency
	2009_1190023	032	9.6	Latency
	2009_1190034	207	9.2	Latency

**PITCH** view parallel to track, same line (at nadir) [opposite direction, same speed]

SV Cast #	HSX Line Filename	Heading	Speed (kts)	Remarks
BOT_0001	2009_1182240	033	6.5	First line!!
	2009_1182305	207	6.4	Pretty good line.
	2009_1182317	032	6.6	good line
	2009_1182332	207	7.0	good line

**HEADING/YAW** view parallel to track, offset lines (outerbeams) [opposite direction, same speed]

SV Cast #	XTF Line Filename	Heading	Speed (kts)	Remarks
BOT_0002	2009_1190112	024	5.5	NW line, good outer beam overlap with feature.
	2009_1190131	213	5.5	SE Good line
	2009_1190147	027	5.5	NW inboard and better overlap
	2009_1190203	213	5.6	SE

**ROLL** view across track, same line [opposite direction, same speed]

SV Cast #	XTF Line Filename	Heading	Speed (kts)	Remarks
BOT_0003	2009_1190307	270	6.2	80m to port at beginning of line
	2009_1190323	090	6.3	lost bottom track mid line
	2009_1190338	270	5.0	poor line tracking
	2009_1190353	090	6.8	good line
	2009_1190408	270	6.3	good line
	2009_1190426	090	6.0	good line

**Processing Log**

4/29/2009 | 119 | Stuart  
 Date Dn Personnel

Data converted --> HDCS\_Data in CARIS

TrueHeave applied PosPac\_S220\_118.000

SVP applied Moira\_Rock\_S220\_SV.svp

Tide applied zerotide.tid

Zone file \_\_\_\_\_

Lines merged

Data cleaned to remove gross fliers

**Compute correctors in this order**

1. Precise Timing      2. Pitch bias      3. Heading bias      4. Roll bias

Do not enter/apply correctors until all evaluations are complete and analyzed.

**PATCH TEST RESULTS/CORRECTORS**

Evaluators	Latency (sec)	Pitch (deg)	Roll (deg)	Yaw (deg)
CST Morgan	0.04	-0.40	-0.04	-0.40
B. Welton	0.00	-0.35	-0.07	0.60
A. Raymond	0.05	-0.16	-0.04	0.55
B. Campbell	0.01	-0.35	-0.04	0.60
FOO	0.00	-0.10	-0.05	0.50
<hr/>				
<b>Averages</b>	0.02	-0.27	-0.05	0.37
<b>Standard Deviation</b>	0.02	0.13	0.029 0.01	0.43 0.05
<b>FINAL VALUES</b>	0.00	-0.27	-0.50	0.37

Final Values based on \_\_\_\_\_

Resulting HVF File Name \_\_\_\_\_

**Actual values used**

MRU Align StdDev gyro 0.43 Value from standard deviation of Heading offset values      0.048 MRU Align StdDev gyro  
 MRU Align StdDev Roll/Pitch 0.07 Value from averaged standard deviations of pitch and roll offset values      0.021 MRU Align StdDev Roll/Pitch

**NARRATIVE**

Data analyzed was collected on Dn 118 and 119.

Initial MRU values were too high, TPU values reassessed with outliers removed.

HVF Hydrographic Vessel File created or updated with current offsets

Name: CST Morgan

Date: 5/6/2009





**PITCH** view parallel to track, same line (nadir) over feature or bounded slope [opposite direction, same speed]

SV Cast #	Line Filename	Heading	Speed (kts)	Remarks
1	2302	270	6.0	Pitch and timing
1	2314	086	6.0	Pitch

**HEADING/YAW** view parallel to track, offset lines from feature or slope (outerbeams) [opposite direction, same speed]

SV Cast #	Line Filename	Heading	Speed (kts)	Remarks
1	2200	100	6.0	Pinnacle recon
1	2212	260	6.2	Pinnacle recon
1	2225	090	6.3	Heading line
1	2238	265	6.1	Heading line
1	2250	080	6.2	Heading line

**ROLL** view across track, same line [run in flat area in opposite direction, same speed]

SV Cast #	Line Filename	Heading	Speed (kts)	Remarks
1	2337	326	5.8	Roll
1	2351	147	6.1	Roll

**Processing Log**

10/6/2009 | 279 | ERT Janice Felzenberg  
 Date Dn Personnel

- Data converted --> HDCS\_Data in CARIS
  - TrueHeave applied 2009-279\_Patch7111.000
  - SVP applied S220\_7111Patch\_2009-279.svp
  - Tide applied Predicted
- Zone file O351FA2009CORP.zdf

Lines merged

Data cleaned to remove gross fliers



G.Rice

2/26/09

## ***Fairweather* Elipsoidally Referenced Dynamic Draft Measurement**

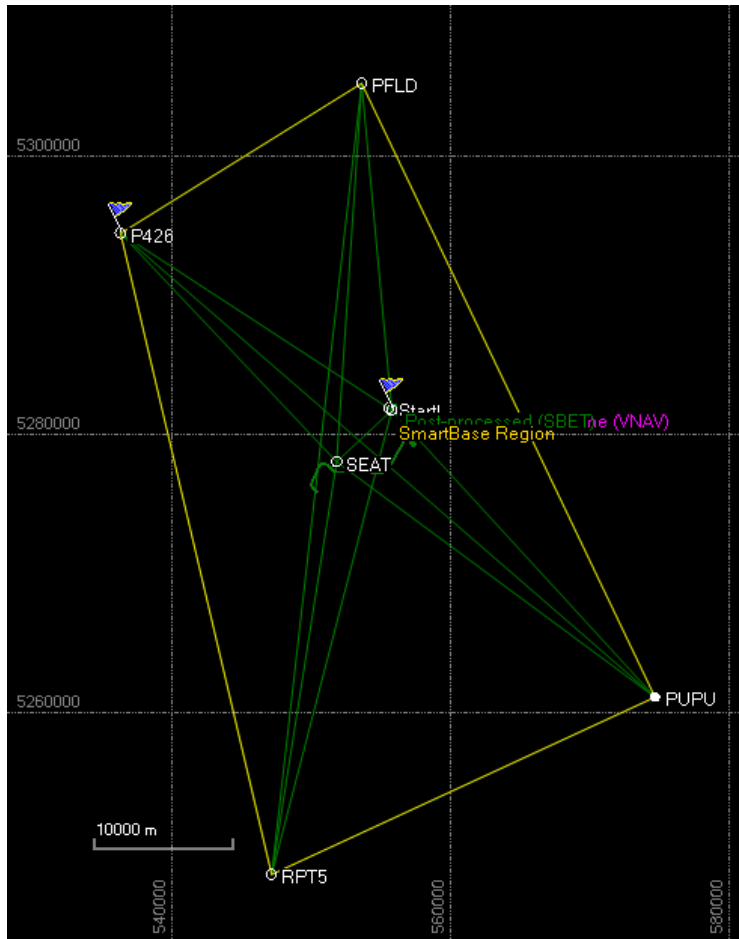
***Lake Washington, February 23<sup>rd</sup> 2009***

On Feb 23<sup>rd</sup>, 2009 the NOAA Ship *Fairweather* conducted a dynamic draft measurement (DDM) on Lake Washington using post processed kinematics (PPK). A standard operating procedure was defined before the test and is included as Appendix A. The plan was to determine the how much, at different speeds, the vessel's draft changes with reference to ellipsoidal height. During the test, *Fairweather* stopped between speeds to allow for a static height measurement. Due to time constraints this test was only run with approximate speeds of 4 knots, 6 knots, 8 knots, and 10 knots.

Because this DDM was conducted on Lake Washington, any change in water level was assumed to be negligible. Since it was further assumed there was no current, speed through the water was determined using over-ground speed (GPS). Wind was from the North at approximately 10 knots. The ship was light on fuel, without launches, and drawing two feet less in the stern than would normally be expected during survey operations.

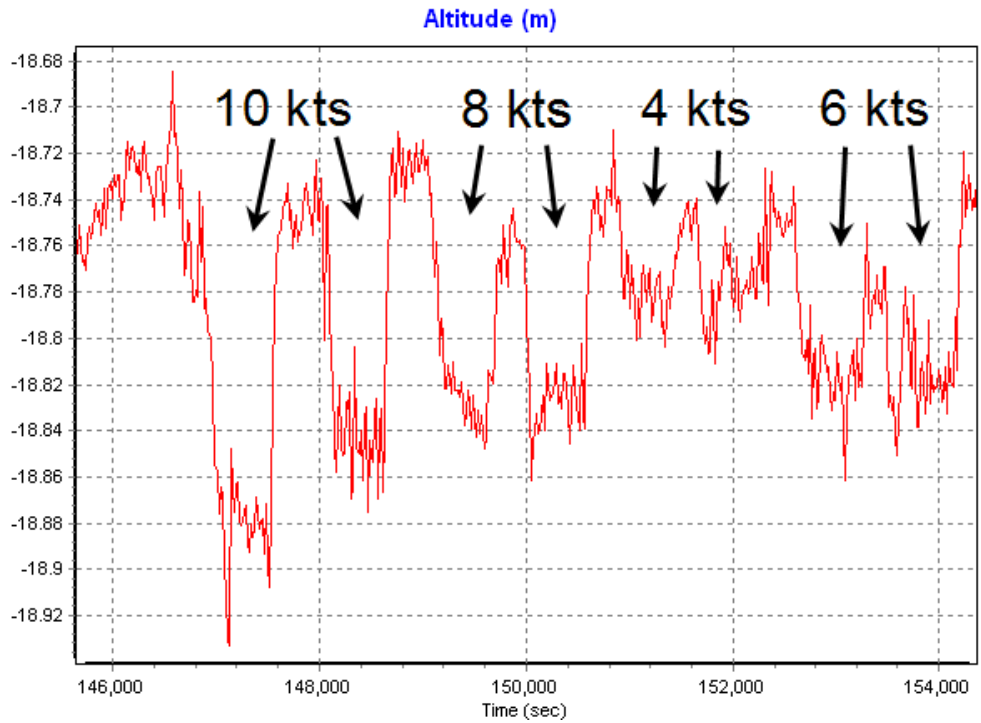
POSPac file recording from the POS/MV began before getting underway, approximately an hour before the DDM was performed. After the test, the data were imported into POSpac processing software and reference stations were uploaded using the "smart select" option. Six stations were selected, three from CORS and three from SOPAC. The Smart Base Quality Check was run and it identified one position to be adjusted and two that could be set to control; these changes were accepted. Applanix Smart Base was run to generate a local virtual reference station. Processors then ran the GNSS-Inertial Processor, using the SmartBase GNSS Mode with a zero initialization for Roll, Pitch and Heading. Lever Arms and Mounting Arms were set to be in the 10cm uncertainty range.

A coordinate system of UTM zone 10 with the GEOID03 (Conus) was used while processing the data. Figure 1 is a screen grab of the network. Reference station distance from the working area ranged from 1500 meters to 35 kilometers.

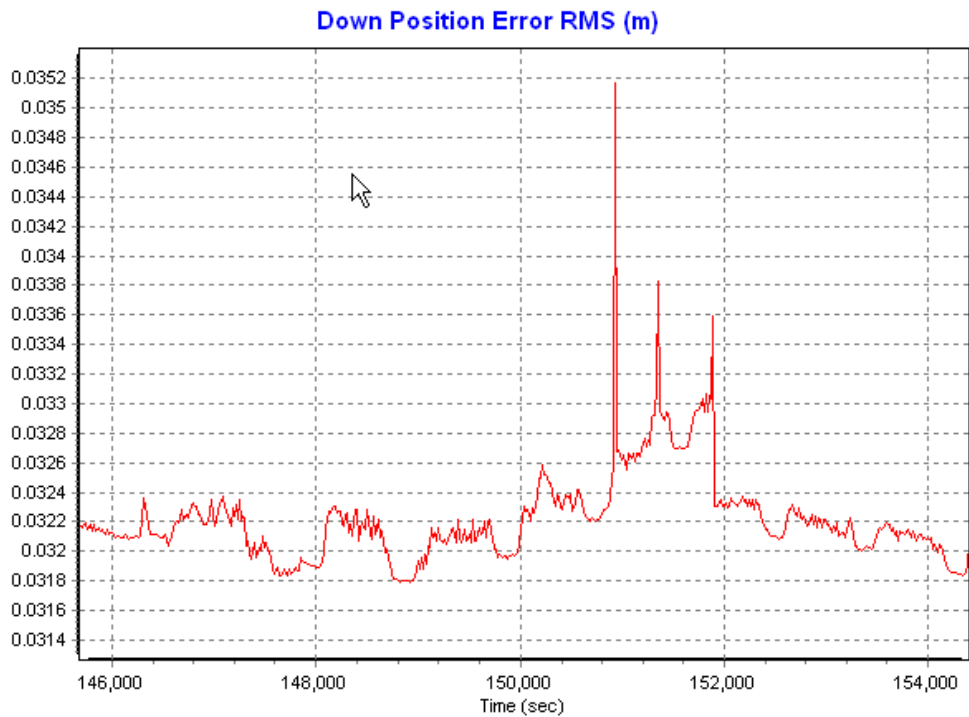


**Figure 1 – The network used consisting of six reference stations.**

Once processed in POSPac the Display Plots were reviewed. No problems were found. The X, Y and Z Reference-Primary GPS Lever Arms varied by as much as 0.2 meters over the course of the exercise, although the Z Lever Arm agreed to within 3cm with the typical values found during the Ernest Sound Project. The Altitude SBET and the associated RMS values can be found in Figure 2 and Figure 3 respectively.

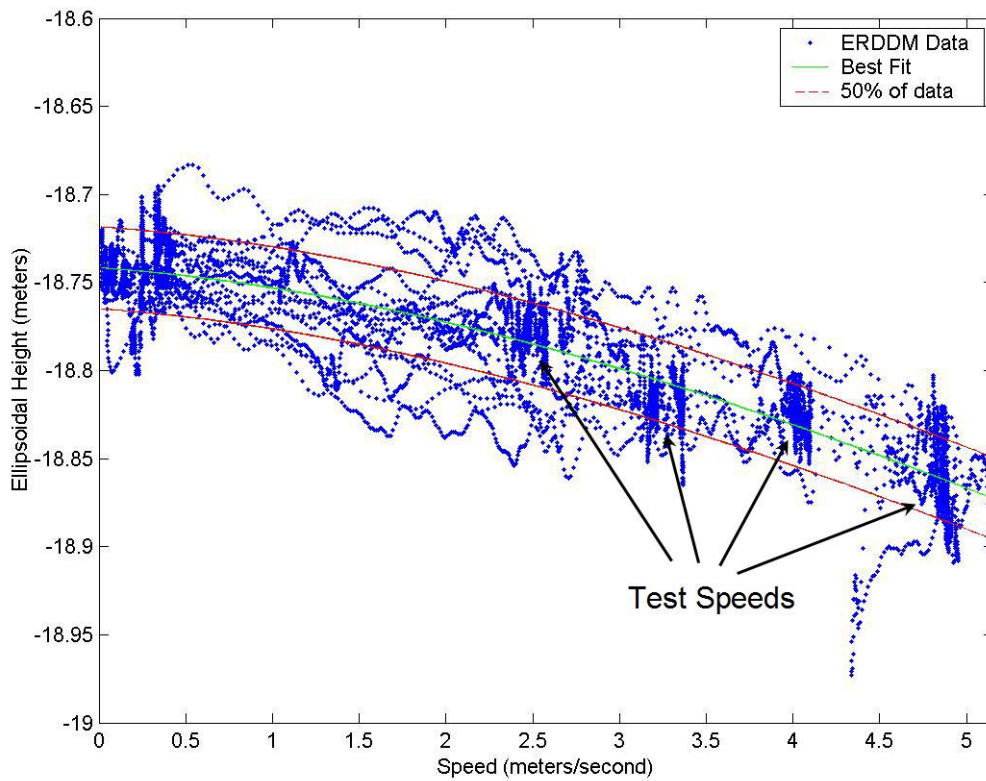


**Figure 2 – The altitude time series during this test as seen in POSPac.**



**Figure 3 – The estimated vertical error time series from POSPac.**

Because the noise associated with altitude readings (Figure 2) is within the uncertainty shown in Figure 3, this noise is not considered significant. Two approaches were considered for determining authentic draft measurement from within the noise. The first approach selects specific sections of data that have relatively small changes in speed and average them for both speed and ellipsoidal height. The draft, then, is the result of subtracting the average ellipsoidal height recorded at rest from the averaged ellipsoidal height at speed. The second method plots a best-fit polynomial curve to the distribution of all data on a speed vs ellipsoidal height axis (Figure 4). This is more robust and just as accurate as the first approach. Consider that survey vessels are often making changes to speed or course during operations, changes for which typical DDM tests do not account. The second method described was used here.



**Figure 4 – Ellipsoidal Height data as a function of the Speed with the best-fit curve.**

Figure 4 shows the data clusters at each of the target speeds. These clusters of data weight the best-fit curve to the correct shape. Data points from speed changes demonstrate the variation likely during survey operations and are an indicator of the

uncertainty for DDM. While the best-fit curve does not pass through each cluster, its proximity is within the vertical uncertainty for these measurements.

The equation for the best-fit curve can be used to give the delta draft table needed by Caris. By simply plugging in different speeds the change in draft is given when the ellipsoidal offset at rest is subtracted from the equation, resulting in a zero y intercept. This is accomplished here by using the y intercept derived by the polynomial fit. If insufficient data from at rest is supplied to the best-fit process or the fit is poor this can result in a vertical offset. Since the table in Caris assumes down is positive the equation will also need to be multiplied by (-1). Equation 1 was derived using the described process and was used to populate Table 1.

$$\Delta Draft = (-2.15 * Speed^3 + 46.93 * Speed^2 + 69.41 * Speed) * 10^{-4} \quad (1)$$

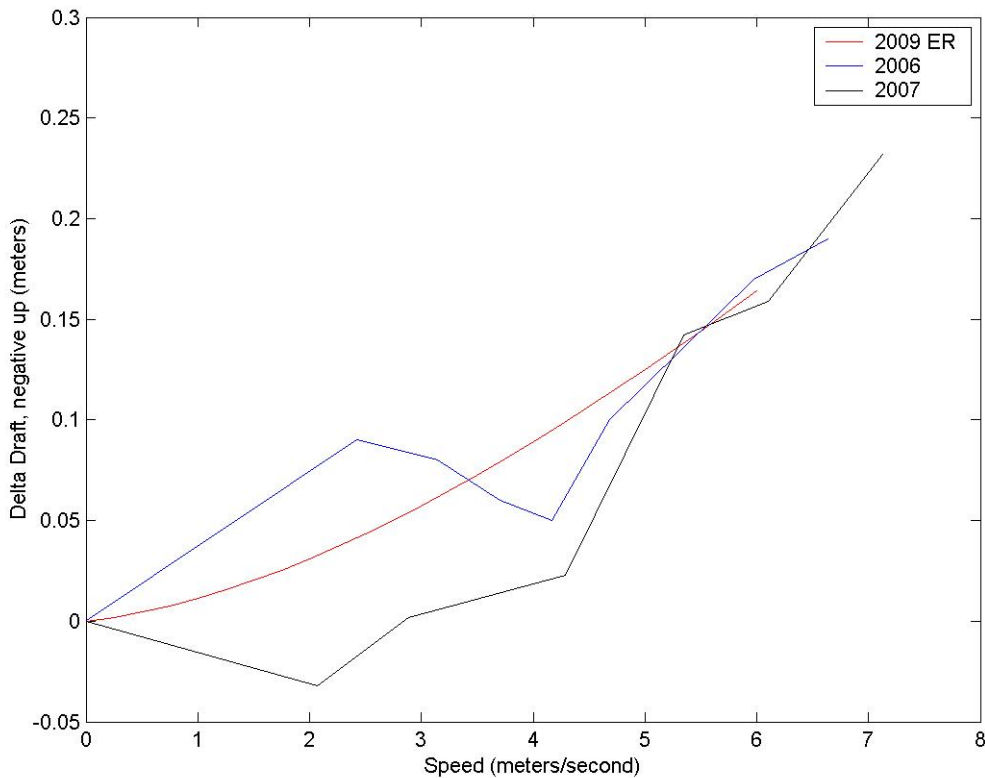
**Table 1 The computed Dynamic Draft Table for Caris**

Speed (m/s)	Delta Draft (m)
0	0
0.5	0.005
1.0	0.011
1.5	0.020
2.0	0.031
2.5	0.043
3.0	0.057
3.5	0.072
4.0	0.089
4.5	0.107
5.0	0.125
5.5	0.144
6.0	0.164



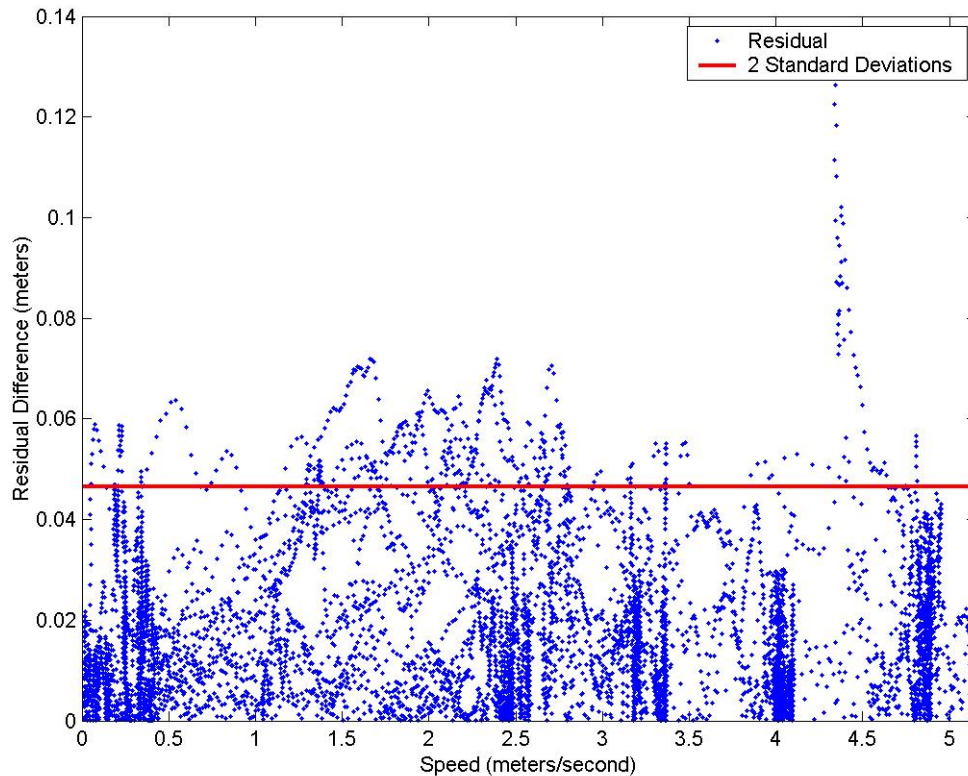
While the number of terms in Equation 1 might be excessive it was deemed prudent to have too many rather than too few coefficients.

Past dynamic draft values for *Fairweather* have varied and have had mixed success. The values used from the 2006 season have generally been accepted to work best and were used for 2008 when the 2008 values proved to be insufficient. Figure 5 allows for a visual comparison of these values.



**Figure 5 – A comparison of the 2009 ellipsoidally referenced measurements to those from previous years.**

The best-fit polynomial curve can be evaluated by subtracting its values from all test data. Calculating the standard deviation for these residual values give an estimate of the uncertainty in the estimate from the best-fit curve (Figure 6).



**Figure 6 – The residual difference between the measurement data and the best-fit curve.**

Two standard deviations for the residual difference was calculated to be 4.7cm. While this is accurate for this test it is not accurate to say this depicts the uncertainty for dynamic draft in general. The changes in draft while changing speed was captured by this method but the further uncertainty caused by currents is not. It is standard for the vessel speed through the water to be approximated by the speed over ground on many NOAA vessels. Since this impacts how Caris implements the dynamic draft table it also impacts the delta draft used.

In conclusion, this method for estimating the dynamic draft appears reliable from the comparison with previous year’s results as well as robust because of its inclusion of many measurements. Due to time constraints this test was limited to four speeds at 10 minutes each. More time at each speed and at more speeds would add to the reliability of the estimates. Differences between the best-fit curves for the geoid verse the ellipsoid varied by as much as 4 mm and was not considered significant.

## Appendix A

G. Rice

2/3/08

### Dynamic Draft Measurements Using POSPac

#### 1. Scope:

This document is for the initial attempt to use POSPac to measure dynamic draft relative to the ellipsoid aboard the NOAA Ship FAIRWEATHER. This process is only a preliminary and should be updated with lessons learned after the initial attempt.

#### 2. Background:

This process is for a body of water with a static water level over short time periods, such as a lake. Tides will not be taken into account and it is assumed that currents are negligible. The ellipsoid is assumed to be relatively parallel to the water level over the area of this test. Time periods of static vessel settlement at the end of each line will help to confirm this assumption. V-datum does exist for the area of Lake Washington (where this test will be performed) so if needed the navigation information can be converted to the geoid. Since vertical data will only be referenced internally (at rest compared to underway) the datum does not matter as long as it is parallel to the water level plane. Because of the availability of reference stations for an established network the data will be processed to the ITRF ellipsoid.

#### 3. Data Collection:

The POS/MV should be turned on and logging POSPac for 30 minutes before the beginning of the evolution. If time allows log the status of water and fuel tanks, which small boats are aboard and what the draft marks read. Once on location for the test sit static for 2 minutes and then again in between every line and again at the end of the test. Each line should be driven at speed for 5 minutes in each direction. The two minute rest can occur before or after turning around to begin the next line. Speed estimates are to

ensure proper space is available for each line only. Maintaining the same shaft RPM and propeller pitch for both directions is more important than having the same speed. Line speeds are as follows:

Line 1 Start/End	Line 2 Start/End	Approximate speed (kts)	Shaft RPM	Propeller Pitch	Comments
		2	120	30	
		4	130	40	
		6	140	50	
		8	150	60	
		10	160	70	
		12	170	80	

Record the start and end time for each line according to the time in the POS Controller.

#### 4. Data Processing:

The data will be processed through POSpac using either a Virtual Reference Station in a network or a single station. Output will likely be examined in either Python or Matlab to estimate actual Dynamic Draft Measurements.



---

## SeaBat 8160 Noise Analysis

### 1.0 Overview

For mid and deep water sonar systems, noise emanating from the vessel on which the sonar is mounted is a major determinant in the performance of the sonar. In addition to sources such as echosounders and other acoustic devices, such as doppler logs, mechanical noise from the engines and drive trains, and flow noise will also affect performance, with the magnitude of the noise varying with vessel speed.

This document describes the noise analysis test done on the RESON SeaBat 8160 installed on the NOAA S/V Fairweather, on 10 October 2004.

### 2.0 Test Conduct

The following is a description of the system setup and test protocol used to test the SeaBat 8160 multibeam sonar.

#### 2.1 Sonar Setup

To determine the amount of in-band noise seen by the sonar, the system was configured as follows:

Setting	Value
Power	Off
Gain	Manual Fixed 20
Range	100 meters

Data collection was done using a RESON engineering utility, which collects the full amplitude and phase time series data from the sonar. Figure 1 shows a sample screen capture, in this case one of the data sets taken at six knots, with a shaft speed of 140 RPM. At least ten (10) collections were done for each test case, and the results for first 10 measurements each test case were averaged for the report.

#### 2.2 Vessel Operation

Normal survey speed for the vessel is approximately 10 knots. To bracket this range, and to check at possible lower survey speeds, the test was defined to cover the range of 2 to 12 knots, in 2 knot steps. The initial tests were at a shaft speed of 130 RPM, with the speed adjusted by changing the pitch on the propellers. Additional tests were run at shaft speeds of 140 and 150 RPM, with the pitch adjusted to achieve speeds of 6, 8 and 10 knots. A log of data collections for the tests is provided in Appendix A.

All the underway data collections were done in water depths of 200 to 300 meters. The zero speed data collections were done at anchor, in water depths of about 30 meters.

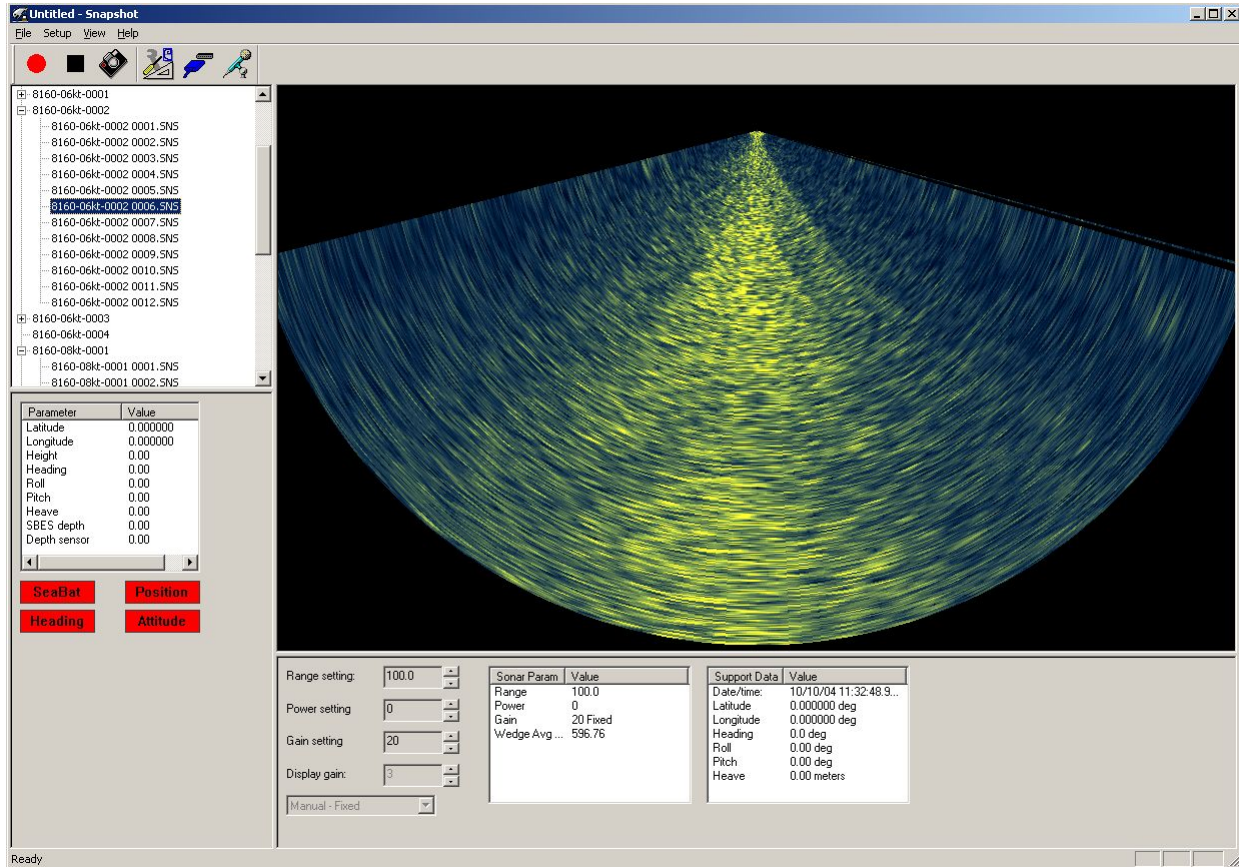


Figure 1 - Snapshot Utility Screen Capture

## 2.3 Data Analysis

The data from each of the test cases were collated in an Excel spreadsheet, shown in Appendix B. A graph of the measured noise levels, as a function of vessel speed and shaft RPM is shown in Figure 2. The noise level is a unitless value that represents the average of all the amplitude samples, from all the beams for the sampled sonar ping. This value represents a combination of the electrical noise in the sonar, and the response to all acoustic energy, within the bandwidth of the sonar, impinging on the receive array.

For each the 130, 140 and 150 RPM tests, the plot shows the noise level as a function of vessel speed. Only one sample was taken at 160 RPM, since to achieve the 12 knot speed, it was necessary to run at that RPM, with the pitch set to maximum test value of 10 feet.

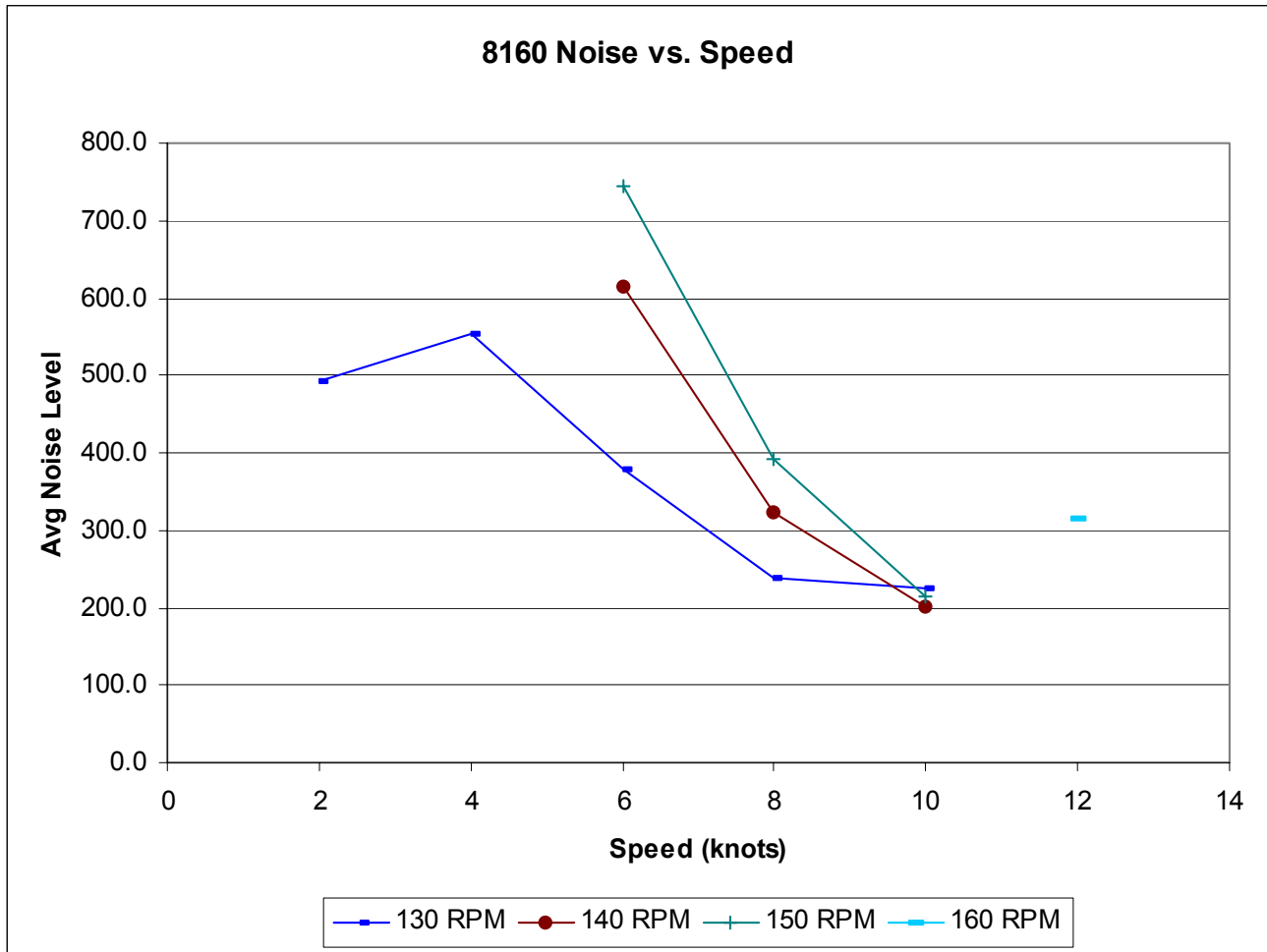


Figure 2 - Noise Plot

### 3.0 Conclusions

- a. It appears that the best survey speed, from a noise perspective, is at approximately 10 knots. Both lower and higher speeds correlate with higher noise levels.
- b. For lower survey speeds, it would be desirable to use a lower shaft RPM, combined with a higher pitch setting, to minimize the noise level seen by the sonar.
- c. The reason for the higher noise levels seen in the zero speed, at anchor collections is undetermined, but may be a result of the much shallower operating depth, and increased reverberation of vessel mechanical noise reflected off the bottom.





## Appendix B – Noise Analysis Spreadsheet

	A	B	C	D	E	F	G	H	I	J	K	L	M
1	8160 Noise Test Results												
2	Speed	Pitch (ft)	1	2	3	4	5	6	7	8	9	10	Average
3	Eng Off												
4	0	407.4	409.7	406.2	414.0	414.5	416.3	417.4	418.6	417.4	417.4	417.8	413.9
5	Eng On												
6	0	1449.6	1363.7	1373.6	1393.3	1495.8	1656.9	1714.9	1597.3	1606.3	1606.3	1829.4	1548.1
7													
8													
9	130 RPM												
10	2	1.5	500.6	519.0	486.3	540.0	490.3	459.0	482.3	456.7	531.7	473.2	493.9
11	4	4	594.5	648.2	624.9	552.5	633.4	623.7	624.4	577.4	612.2	58.2	554.9
12	6	6	395.0	407.6	355.7	385.4	357.1	386.7	381.0	354.0	404.2	361.1	378.8
13	8	8	231.2	233.3	230.2	233.2	240.3	233.7	241.2	240.3	238.6	262.9	238.5
14	10	10	233.8	221.1	223.3	222.0	222.8	225.6	224.1	223.4	225.5	237.3	225.9
15													
16													
17	RPM 140												
18	6	5	650.8	686.4	648.0	628.3	608.1	596.8	614.1	589.9	572.8	560.5	615.6
19	8	7	330.4	334.9	309.92	330.7	338.5	308.9	308.3	314.5	360.2	312.5	323.9
20	10	9.5	211.0	202.0	201.4	201.0	198.3	196.9	202.3	199.9	198.1	197.1	200.8
21													
22	RPM 150												
23	6	4.5	729.8	638.1	769.8	898.7	740.0	782.7	787.7	687.2	667.8	747.0	743.9
24	8	6.5	428.7	396.0	396.3	391.6	473.6	380.3	432.0	309.7	375.5	336.3	392.0
25	10	9	212.1	214.0	216.5	213.6	217.5	214.2	216.6	216.9	210.3	207.2	213.9
26													
27	160 RPM												
28	12	10	324.8	317.1	324.5	308.2	313.3	346.6	315.8	304.7	301.4	303.5	316.0
29													



---

## SeaBat 8111 Noise Analysis

### 1.0 Overview

For mid and deep water sonar systems, noise emanating from the vessel on which the sonar is mounted is a major determinant in the performance of the sonar. In addition to sources such as echosounders and other acoustic devices, such as doppler logs, mechanical noise from the engines and drive trains, and flow noise will also affect performance, with the magnitude of the noise varying with vessel speed.

This document describes the noise analysis test done on the RESON SeaBat 8111 installed on the NOAA S/V Fairweather, on 11 October 2004.

### 2.0 Test Conduct

The following is a description of the system setup and test protocol used to test the SeaBat 8111 multibeam sonar.

#### 2.1 Sonar Setup

To determine the amount of in-band noise seen by the sonar, the system was configured as follows:

Setting	Value
Power	Off
Gain	Manual Fixed 20
Range	100 meters

Data collection was done using a RESON engineering utility, which collects the full amplitude and phase time series data from the sonar. Figure 1 shows a sample screen capture, in this case one of the data sets taken at six knots, with a shaft speed of 140 RPM. At least ten (10) collections were done for each test case, and the results for first 10 measurements each test case were averaged for the report.

#### 2.2 Vessel Operation

Normal survey speed for the vessel is approximately 10 knots. To bracket this range, and to check at possible lower survey speeds, the test protocol was defined to cover the range of 2 to 12 knots, in 2 knot steps. The tests were conducted at shaft speeds of 120 to 170 RPM, in 10 RPM steps, with the speed adjusted by changing the pitch on the propellers. For each RPM value, the speeds that could be achieved at that shaft speed were tested. A log of data collections for the tests is provided in Appendix A.

All the underway data collections were done in water depths of 120 to 160 fathoms. The zero speed data collections, with the engines on, were done at anchor in about 30 meters of water, and out in the bay, at water depths of about 130 fathoms.

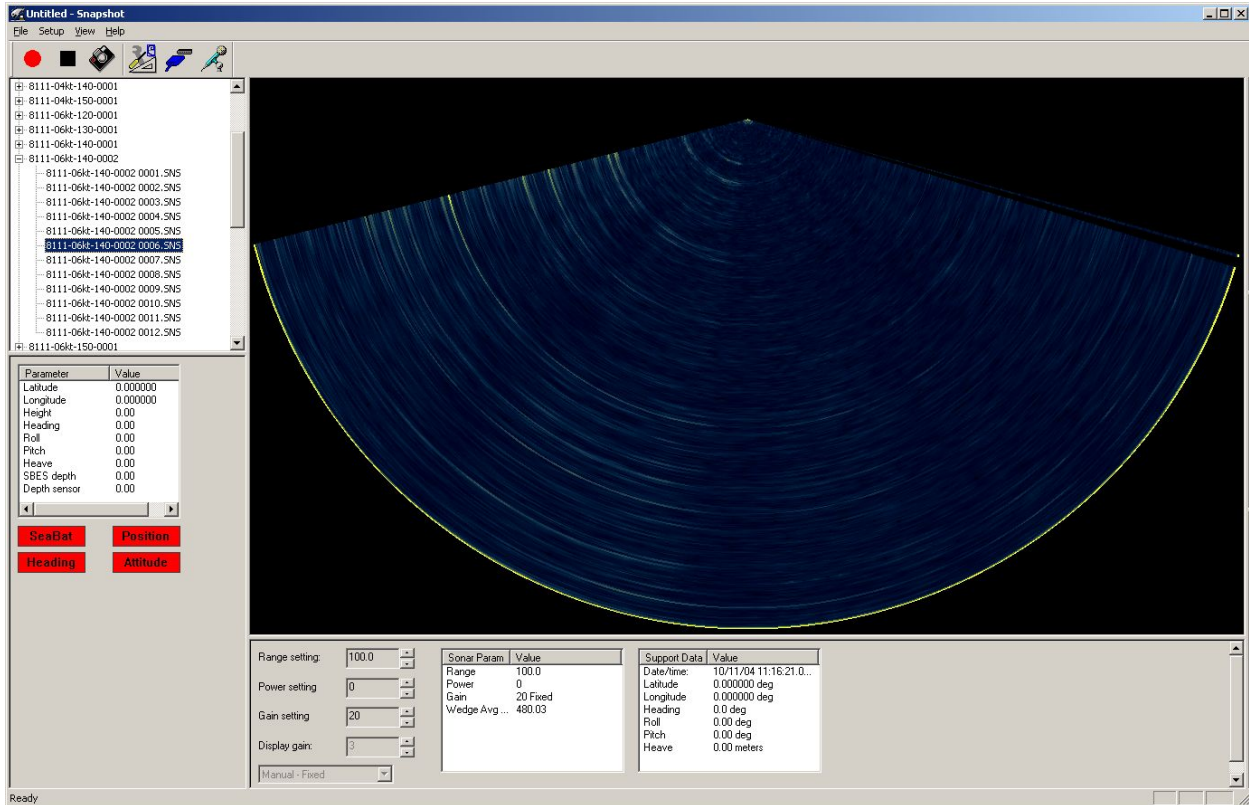


Figure 1 - Snapshot Utility Screen Capture

### 2.3 Data Analysis

The data from each of the test cases were collated in an Excel spreadsheet, shown in Appendix B. A graph of the measured noise levels, as a function of vessel speed and shaft RPM is shown in Figure 2. The noise level is a unitless value that represents the average of all the amplitude samples, from all the beams for the sampled sonar ping. This value represents a combination of the electrical noise in the sonar, and the response to all acoustic energy, within the bandwidth of the sonar, impinging on the receive array.

For each the tests, the plot shows the noise level as a function of vessel speed. Again, the tests were run at the speeds that could be achieved at the selected shaft RPM.

In an effort to resolve the cause of the high noise levels at anchor seen in the 8160 tests, noise tests with the engines at idle (110 shaft RPM, 0 pitch) in both shallow and deep water. In deeper

water, much lower noise levels were observed, apparently due to the greater attenuation of the noise from the various acoustic sources on the ship over the greater range.

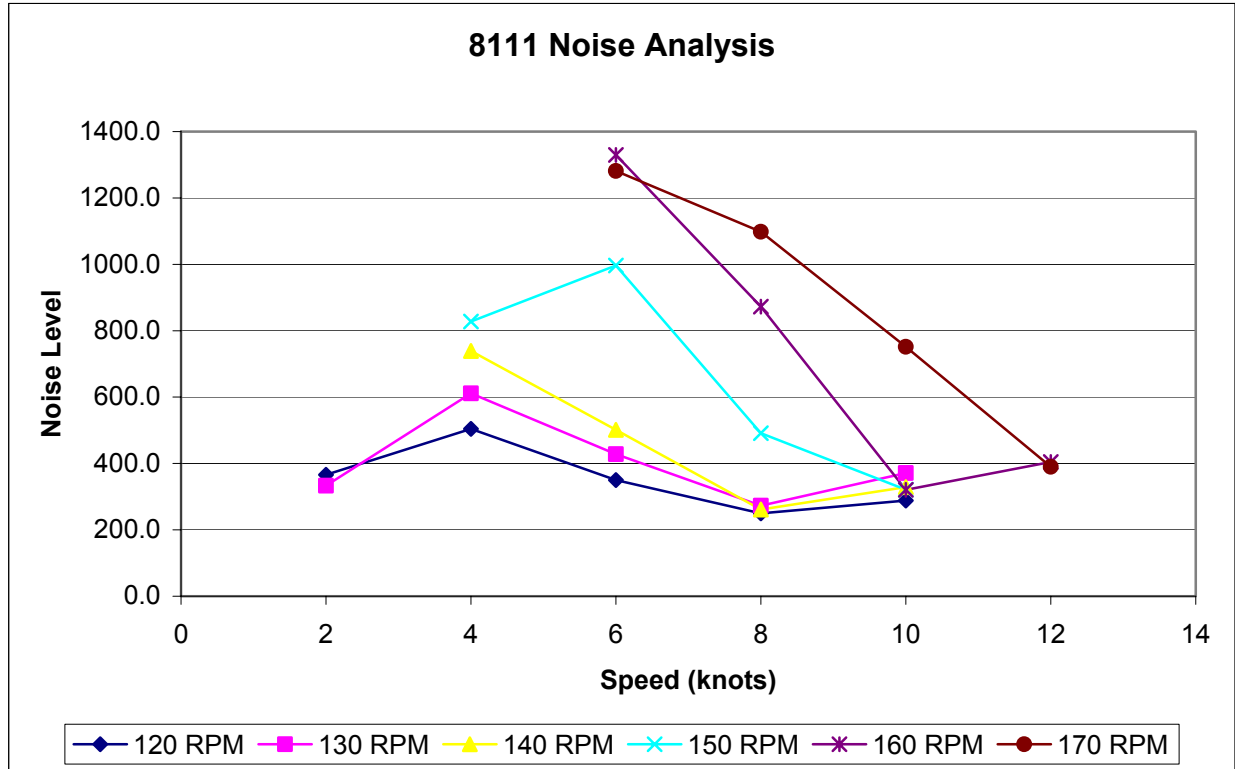


Figure 2 - Noise Plot

### 3.0 Conclusions

- It appears that the best survey speed for the 8111, from a noise perspective, is in the range of 8 to 10 knots. Both lower and higher speeds correlate with higher noise levels.
- It would be desirable to use shaft speeds of 140 RPM, or lower, to minimize the noise level seen by the sonar.
- Significantly increased levels of reverberation from acoustic sources on the vessel are seen in shallower water. If this causes any degradation in the quality of the soundings in the 8111, increased power levels, higher than those recommended in the sonar settings guide, should be used to compensate.



## Appendix A – Test Logs

	A	B	C	D	E	F	G	H	I	J	K	L	M
1	<b>RESON Inc.</b>												
2	<b>Date:</b>	10/11/2004				<b>Survey Area:</b>	Rudyerd Bay, AK				<b>Page / Pages:</b>	1 of 2	
3	<b>Survey Name:</b>	8111 Noise Test				<b>Surveyors:</b>	B Bridge				<b>TimeZone:</b>	-9	
4	<b>Survey Vessel:</b>	NOAA Fairweather				<b>Client:</b>	NOAA						
5	<b>Offset Information</b>												
6			X	Y	Z	Latency	Roll	Pitch	Yaw		SVP File:		
7	<b>Sounder</b>										Tide File:		
8	<b>DGPS</b>												
9	<b>Motion Sensor</b>												
10	<b>Other</b>					<b>Date of Patch Test</b>					Total Pole minus Dry Pole		
11											<b>Draft (Z)</b>		
12	<b>Start</b>	<b>Stop</b>	<b>Line</b>			<b>Dir.</b>	<b>Speed</b>	<b>COMMENTS</b>					
13			8111-00kt-EngOn-0001				0	Gain MF20, Power 0, Range 100, at anchor, 110 RPM					
14			8111-00kt-0001				0	110 RPM 0 Pitch					
15			8111-02kt-120-0001				2	120 RPM 1.0 Pitch 0.4 Doppler					
16			8111-04kt-120-0001				4	120 RPM 3.0 Pitch 2.8 Doppler					
17			8111-06kt-120-0001				6	120 RPM 6.0 Pitch 4.6 Doppler					
18			8111-08kt-120-0001				8	120 RPM 8.5 Pitch 6.7 Doppler					
19			8111-10kt-120-0001				9	120 RPM 10.0 Pitch 7.2 Doppler					
20			8111-10kt-130-0001				10	130 RPM 10.0 Pitch 8.2 Doppler					
21			8111-08kt-130-0001				8	130 RPM 7.0 Pitch 6.2 Doppler					
22			8111-06kt-130-0001				6	130 RPM 5.0 Pitch 4.5 Doppler					
23			8111-04kt-130-0001				4	130 RPM 3.0 Pitch 2.2 Doppler					
24			8111-02kt-130-0001				2	130 RPM 1.5 Pitch 0.5 Doppler					
25			8111-04kt-140-0001				4	140 RPM 2.5 Pitch 2.5 Doppler					
26			8111-06kt-140-0001				6	140 RPM 4.75 Pitch 4.3 Doppler Too Shallow					
27			8111-06kt-140-0002				6	140 RPM 5.3 Pitch 5.2 Doppler					
28			8111-08kt-140-0001				8	140 RPM 7.4 Pitch 6.5 Doppler					
29			8111-10kt-140-0001				10	140 RPM 9.0 Pitch 8.5 Doppler					
30													
31													
32	<b>Survey Manager:</b>						<b>Client Representative:</b>						
33	Signature:						Signature:						
34													
35													



Survey Log - 8111 Noise Test Pg2.xls												
A	B	C	D	E	F	G	H	I	J	K	L	M
1	<b>RESON Inc.</b>											
2	<b>Date:</b>	10/11/2004	<b>Survey Area:</b>	Rudyerd Bay, AK	<b>Page / Pages:</b>	2 of 2						
3	<b>Survey Name:</b>	8111 Noise Test	<b>Surveyors:</b>	B Bridge	<b>TimeZone:</b>	-9						
4	<b>Survey Vessel:</b>	NOAA Fairweather	<b>Client:</b>	NOAA								
5	<b>Offset Information</b>											
6		X	Y	Z	Latency	Roll	Pitch	Yaw	SVP File:			
7	<b>Sounder</b>								Tide File:			
8	<b>DGPS</b>											
9	<b>Motion Sensor</b>									Total Pole		
10	<b>Other</b>									minus Dry Pole		
11										<b>Draft (Z)</b>		
12	<b>Start</b>	<b>Stop</b>	<b>Line</b>			<b>Dir.</b>	<b>Speed</b>	<b>COMMENTS</b>				
13			8111-10kt-150-0001				10	Gain MF20, Power 0, Range 100, 150, 8.2, 7.4				
14			8111-08kt-150-0002				8	150 RPM 6.1 Pitch 6.3 Doppler				
15			8111-06kt-150-0001				6	150 RPM 4.3 Pitch 4.4 Doppler				
16			8111-04kt-150-0001				4	150 RPM 3.0 Pitch 2.8 Doppler				
17			8111-06kt-160-0001				6	160 RPM 4.0 Pitch 5.2 Doppler				
18			8111-08kt-160-0001				8	160 RPM 6.1 Pitch 6.5 Doppler				
19			8111-10kt-160-0001				10	160 RPM 8.2 Pitch 8.8 Doppler				
20			8111-12kt-160-0001				11.7	160 RPM 10. Pitch 9.9 Doppler				
21			8111-12kt-170-0001				12	170 RPM 9.0 Pitch 10.4 Doppler				
22			8111-06kt-170-0001				6	170 RPM 4.0 Pitch 4.8 Doppler				
23			8111-08kt-170-0001				8	170 RPM 5.9 Pitch 6.8 Doppler				
24			8111-10kt-170-0001				10	170 RPM 7.0 Pitch 8.3 Doppler				
25												
26												
27												
28												
29												
30												
31												
32	Survey Manager:					Client Representative:						
33	Signature:					Signature:						
34												
35												

## Appendix B – Noise Analysis Spreadsheet

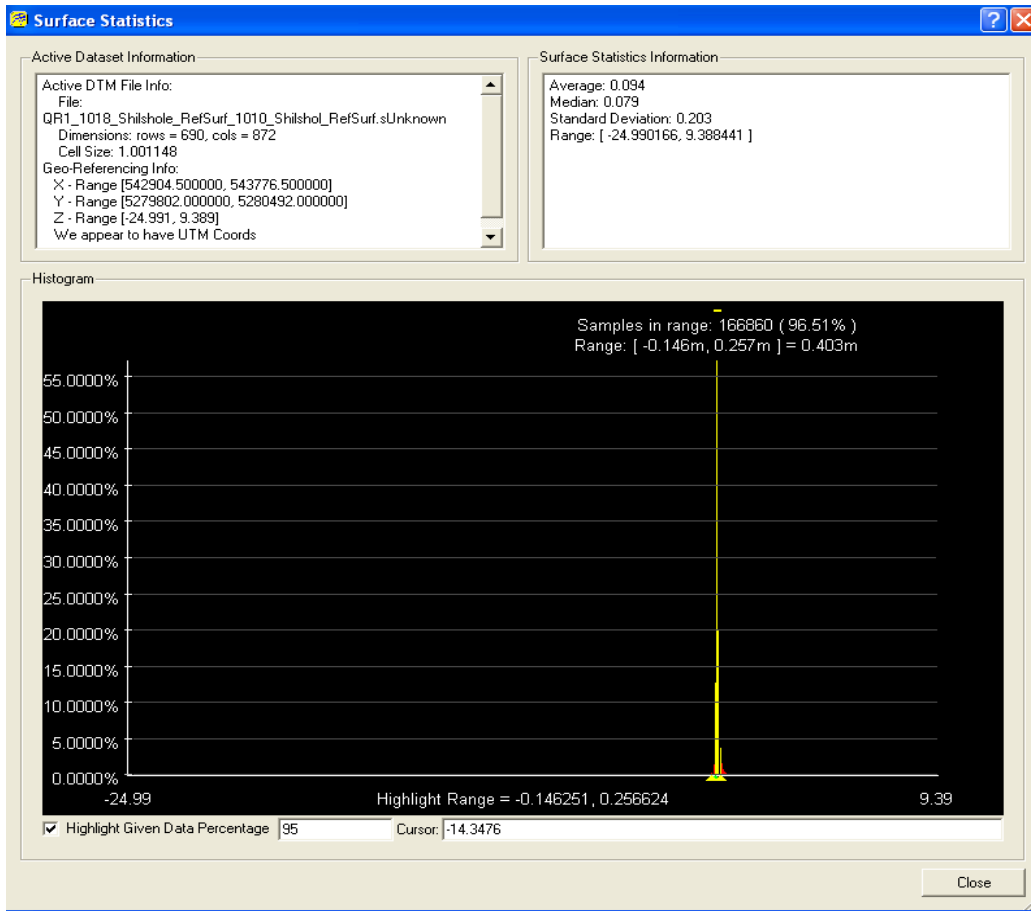
8111 Noise Test Results

Test Condition	Speed	Pitch (ft)	Test Case										Average
			1	2	3	4	5	6	7	8	9	10	
Eng On Shallow Eng On Deep 120 RPM	0	0	707.5	740.2	754.1	711.4	728.1	710.6	691.5	747.9	813.7	722.1	732.7
	0	0	209.0	208.4	208.6	207.2	205.6	211.2	206.3	208.8	210.9	210.0	208.6
	2.0	1.0	382.8	363.0	363.6	330.6	447.5	315.2	389.0	322.1	371.9	371.1	365.7
	4.0	3.0	552.7	431.0	555.9	480.0	517.9	448.0	472.8	500.7	583.6	499.2	504.2
	6.0	6.0	325.5	332.9	302.5	322.9	324.8	364.2	325.8	384.3	409.1	407.4	349.9
	8.0	8.5	253.8	244.0	250.3	253.0	248.4	241.0	241.7	252.4	253.5	259.1	249.7
	9.0	10.0	298.8	296.8	277.4	306.1	284.1	274.0	274.1	290.1	287.5	291.9	288.1
	2.0	1.5	316.9	363.0	366.1	429.6	317.1	313.9	303.7	315.5	315.5	289.4	333.1
	4.0	3.0	671.0	657.4	700.4	632.7	602.6	631.0	552.5	605.8	537.9	523.7	611.5
	6.0	5.0	488.2	471.1	410.9	497.2	387.7	390.9	431.0	448.9	361.3	393.5	428.1
RPM140	8.0	7.0	285.2	279.1	276.7	266.2	287.8	268.3	271.0	262.5	283.4	249.9	273.0
	10.0	10.0	362.8	396.1	378.8	378.2	370.2	391.7	354.6	369.9	334.3	374.0	371.1
	4	2.5	763.9	725.6	689.0	723.3	759.5	751.5	773.5	750.6	689.0	785.7	739.2
	6	5.3	487.1	551.5	605.3	596.4	444.3	480.0	416.2	500.0	452.6	478.9	501.2
	8	7.4	261.5	257.6	260.7	273.1	259.8	274.8	255.0	252.1	248.7	270.6	261.4
	10	9.0	301.5	366.3	328.4	360.1	359.9	328.4	326.2	315.0	302.7	300.4	328.8
	4	3.0	775.2	766.3	916.9	809.7	815.4	860.6	710.5	801.1	892.1	928.6	827.6
	6	4.3	1058.7	926.7	737.5	1015.6	1028.1	1086.3	1048.8	1133.8	997.3	931.8	996.5
	8	6.1	507.8	587.2	535.4	486.4	507.3	443.4	460.9	537.6	461.0	406.4	491.3
	10	8.2	299.2	294.1	315.8	306.5	308.4	323.2	348.8	336.8	332.8	344.5	321.0
RPM150	6	4.0	1488.4	1551.6	1328.3	1454.8	1456.9	1518.9	1256.4	1146.3	1089.5	1005.8	1329.7
	8	6.1	740.7	777.4	926.5	904.7	851.6	817.7	886.5	801.0	1005.7	1015.9	872.8
	10	8.2	339.9	330.9	335.0	329.4	300.6	326.7	316.9	311.6	313.7	300.9	320.6
	6	4.0	1240.1	1173.3	1016.2	1346.1	1301.8	1391.5	1520.2	1327.6	1320.2	1176.3	1281.3
	8	5.9	961.9	1096.9	1229.4	1017.2	1041.2	1168.9	1176.6	1060.5	1117.9	1112.2	1098.3
	10	7.0	756.2	751.3	747.9	640.1	769.5	844.8	714.6	795.6	787.4	709.4	751.7
	4	2.5	396.2	360.1	552.7	339.9	348.5	339.3	352.6	366.5	502.1	351.7	390.0
	6	5.3	487.1	551.5	605.3	596.4	444.3	480.0	416.2	500.0	452.6	478.9	501.2
	8	7.4	261.5	257.6	260.7	273.1	259.8	274.8	255.0	252.1	248.7	270.6	261.4
	10	9.0	301.5	366.3	328.4	360.1	359.9	328.4	326.2	315.0	302.7	300.4	328.8

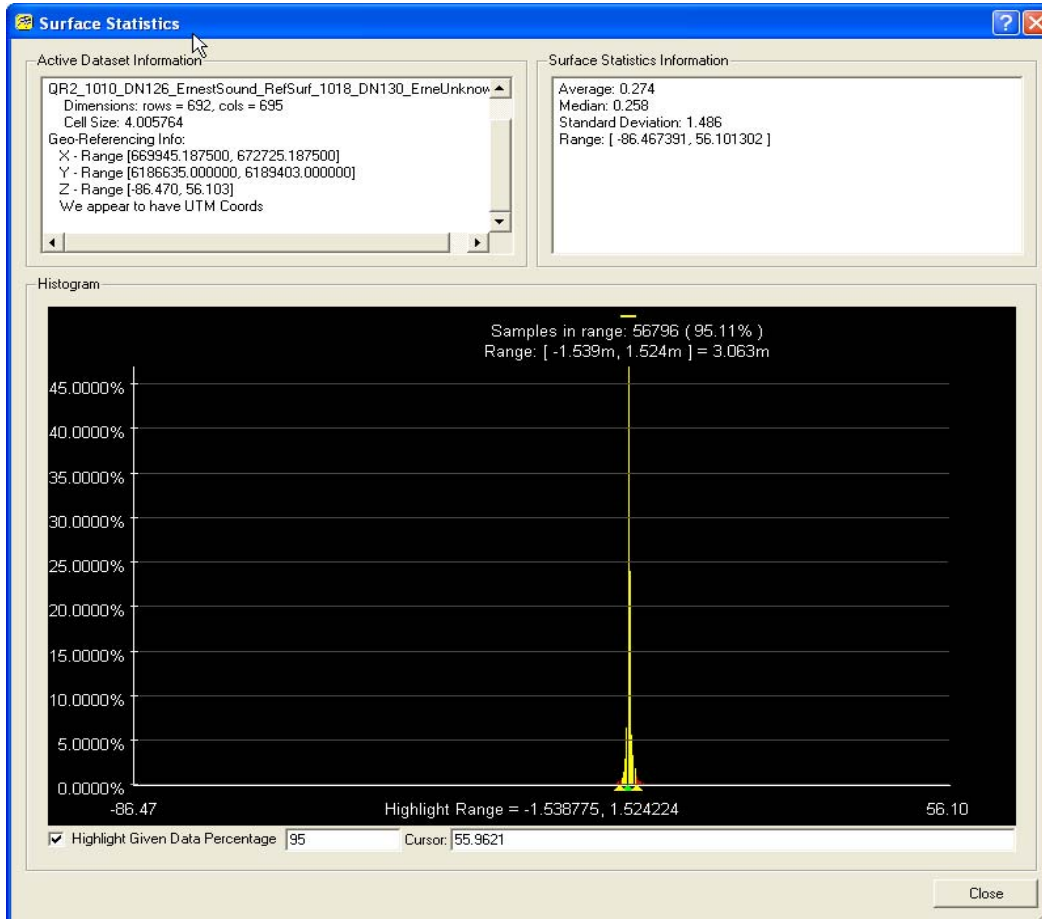
### Sounding Systems Comparison - Fairweather 2009

DNs of lines used for comparison	Location (Lat, Lon)	Vessel and Sounding System	Raw Depth (m)	Processed Depth (m)	System Operator	Comments
DN108 DN109	Submerged wreck, Shilshole reference surface	1010 8101 1018 8101		8.405 8.205	Andrews, Rice, Beduhn, Argento, Renoud, Welton	Comparison is between processed depths from two different days queried in subset mode. Queried depths are on the top part of the wreck.
DN119	Shoal in Moira Rock reference surface	S220 Reson 8111 S220 Reson 8160		137.186 137.097	Campbell, Francksen, Stuart	Comparison is between processed depths queried in subset mode. Queried depths are on the top of shoal.
DN126 DN130 DN128	Shoal in Ernest Sound Reference surface	1010 8101 1018 8101 S220 Reson 8111		26.29 26.23 26.21		Comparison is between processed depths queried in subset mode. Queried depths are on the top of shoal.
DN133	Ernest Sound 55/54.61N 132/16.99W	1010 8101 Leadline	11.49 11.75		Andrews, Beduhn, Marcum	Comparison is between a raw lead line depth raw depth read from Reson 8111 system. Not procesesed for tide.
DN 194	Herendeen Is, Shumagin Islands	Odom Echotrac Leadline	8.9m 9m		Argento, Beduhn, Rice	Comparison between a lead line and the Odom Echotrac CVM using the 4 200Hz transducer.
DN 194	Herendeen Is, Shumagin Islands	Odom Echotrac Ambar	18.3m 17.8m		Argento, Beduhn, Rice	Comparison between the Ambar's Raymarine 200Hz transducer and the Odom Echotrac CVM using the 4 200Hz transducer.

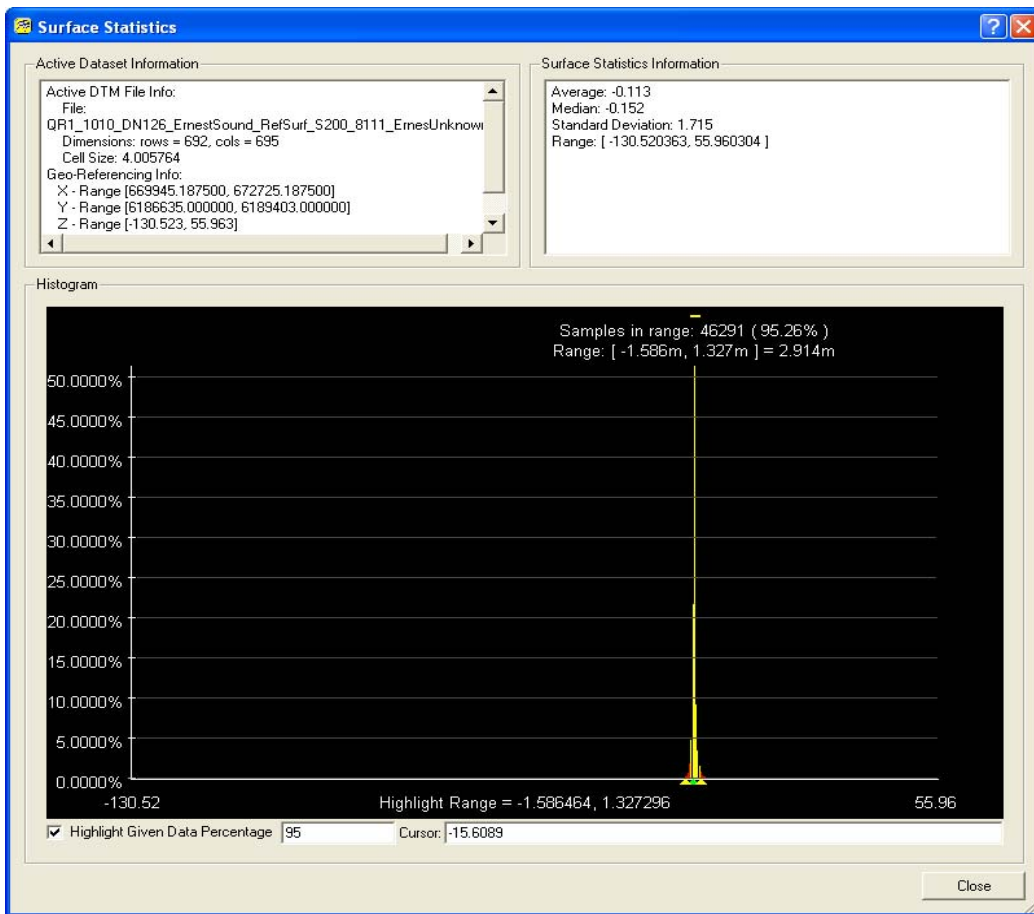




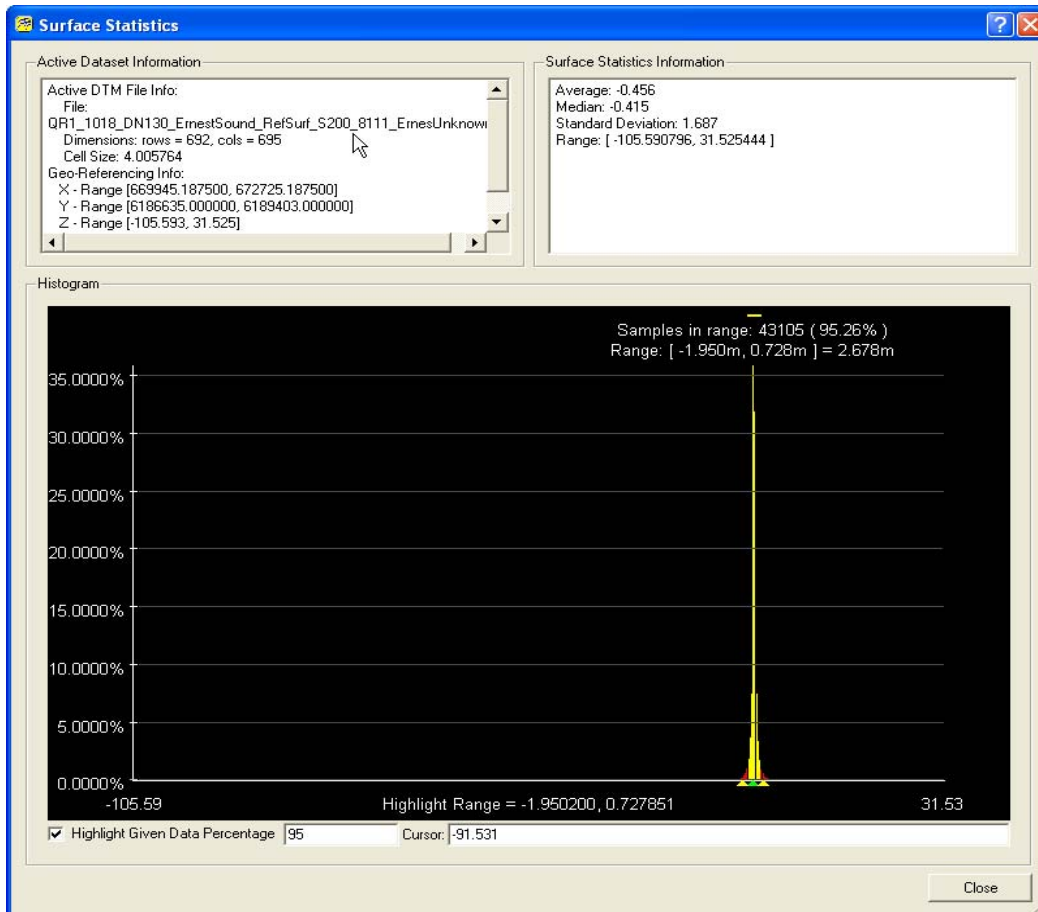
Shilshole Reference Surface 1010-1018



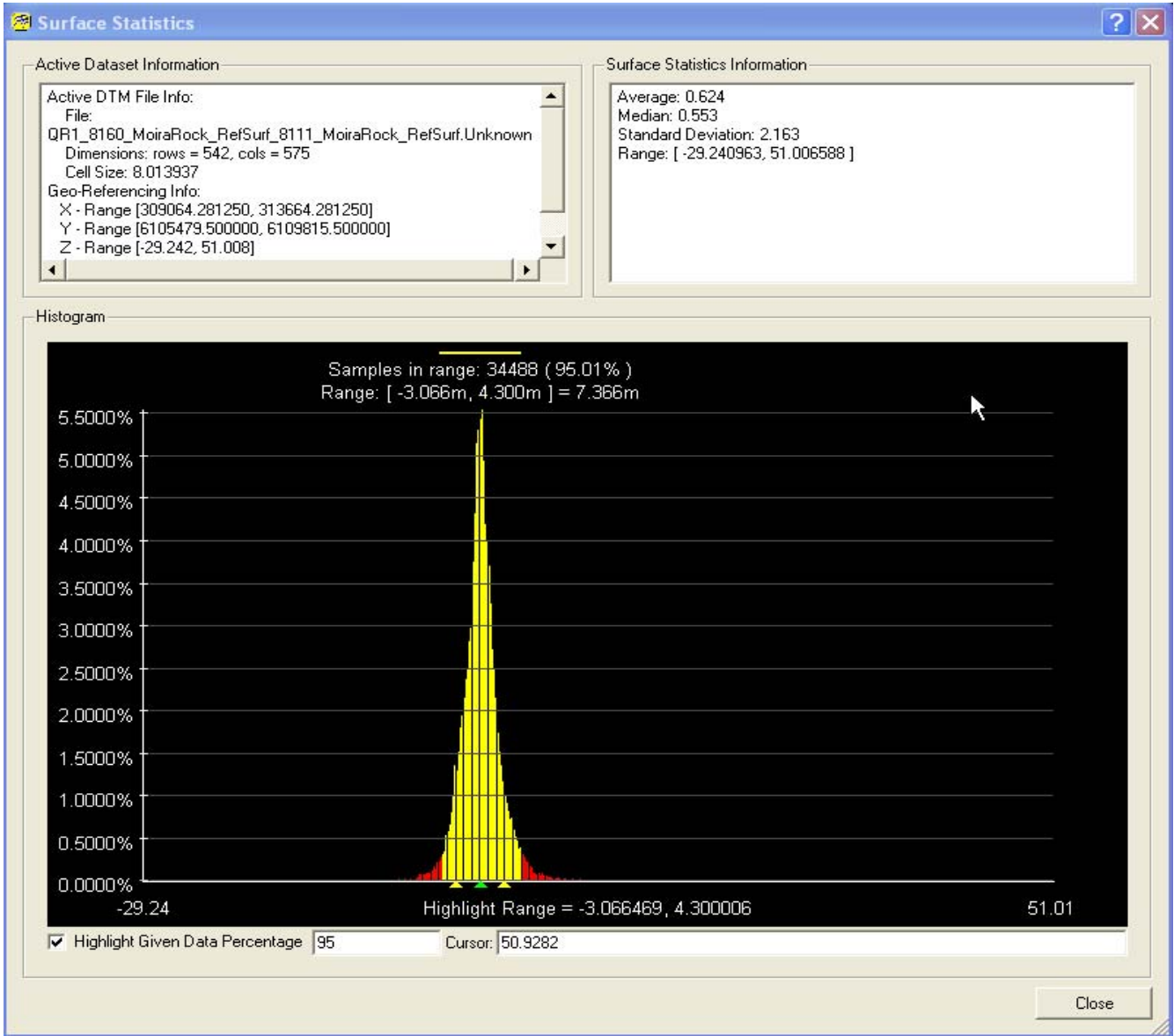
Ernest Sound Reference Surface 1010-1018



Ernest Sound Reference Surface S220\_8111-1010\_8101

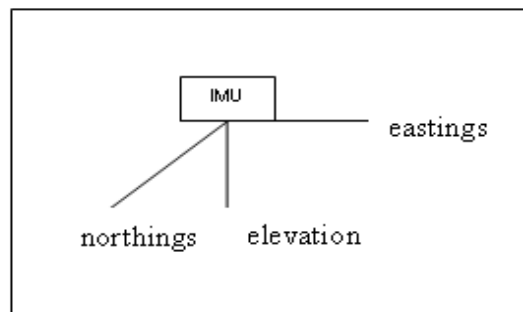
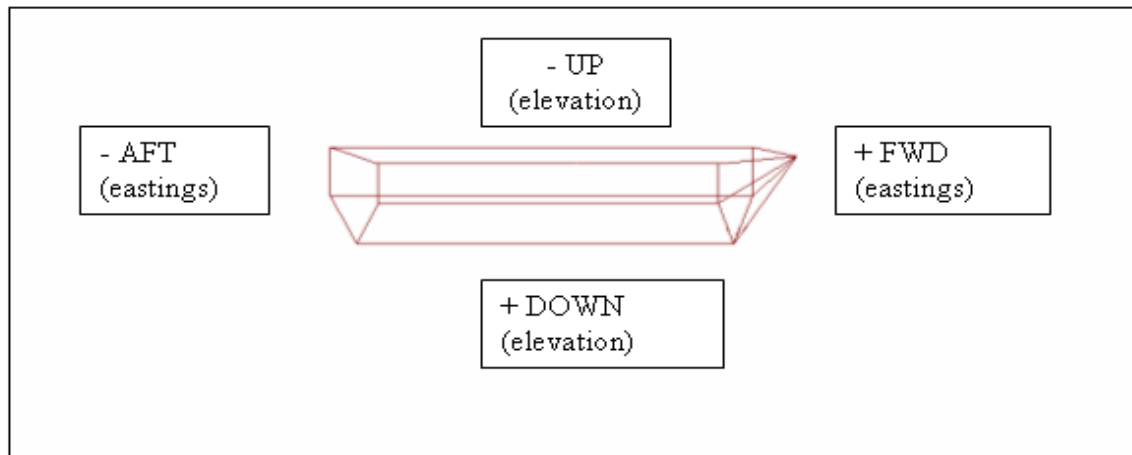
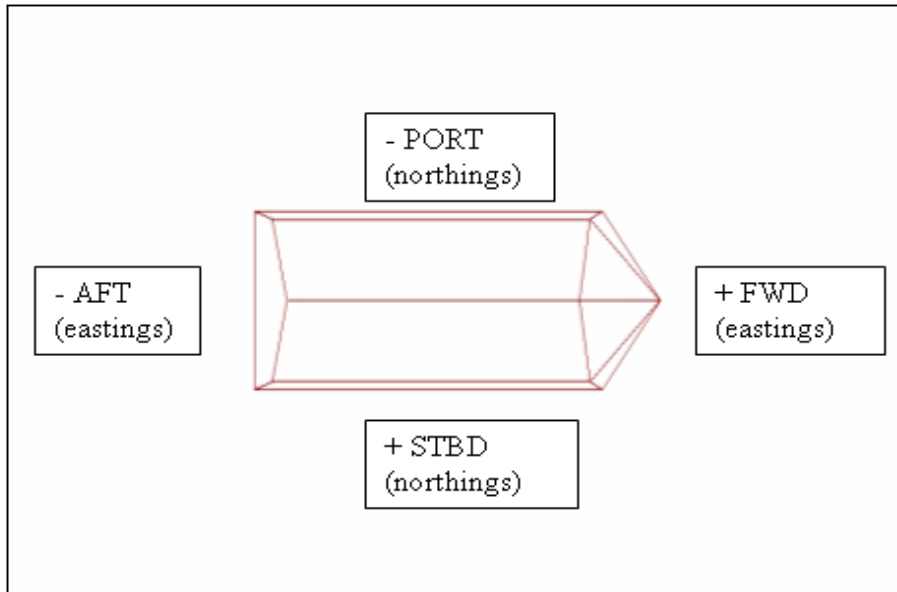


Ernest Sound Reference Surface S220\_8111-1018\_8101



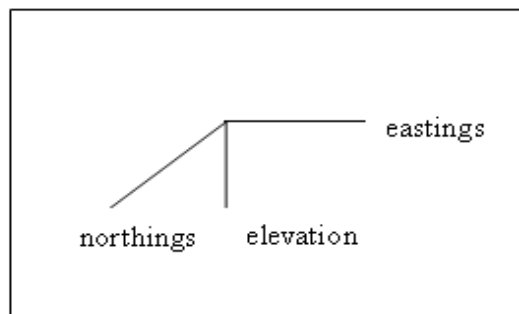
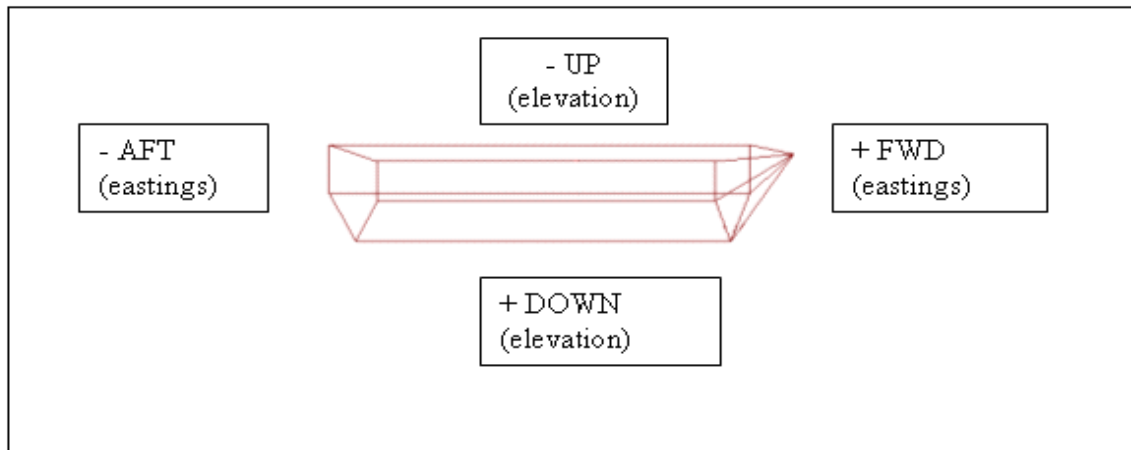
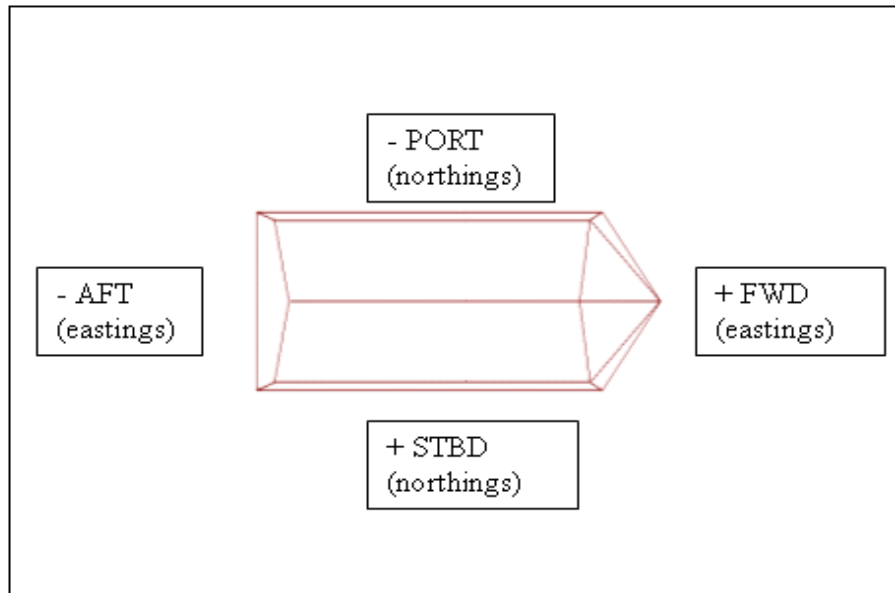
**Moira Rock Reference Surface S200 8111-8160**

## WESTLAKE Coordinate System



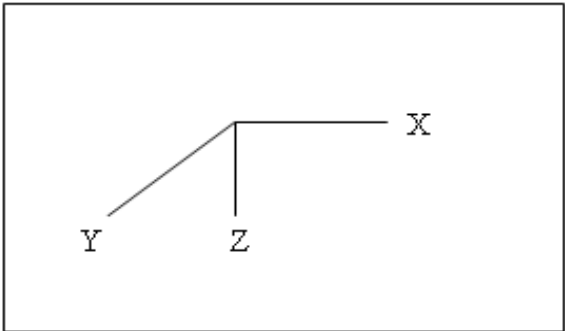
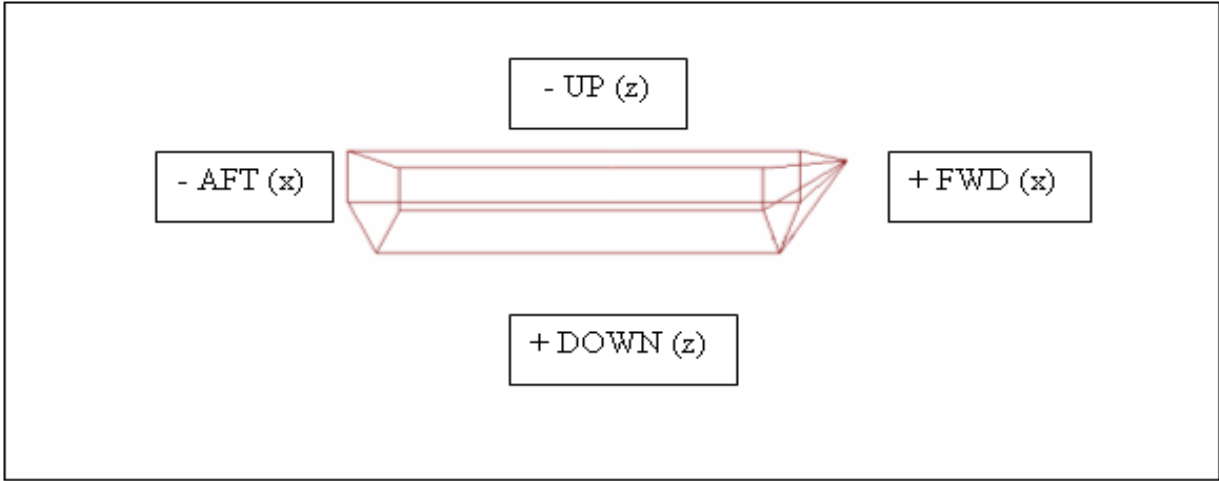
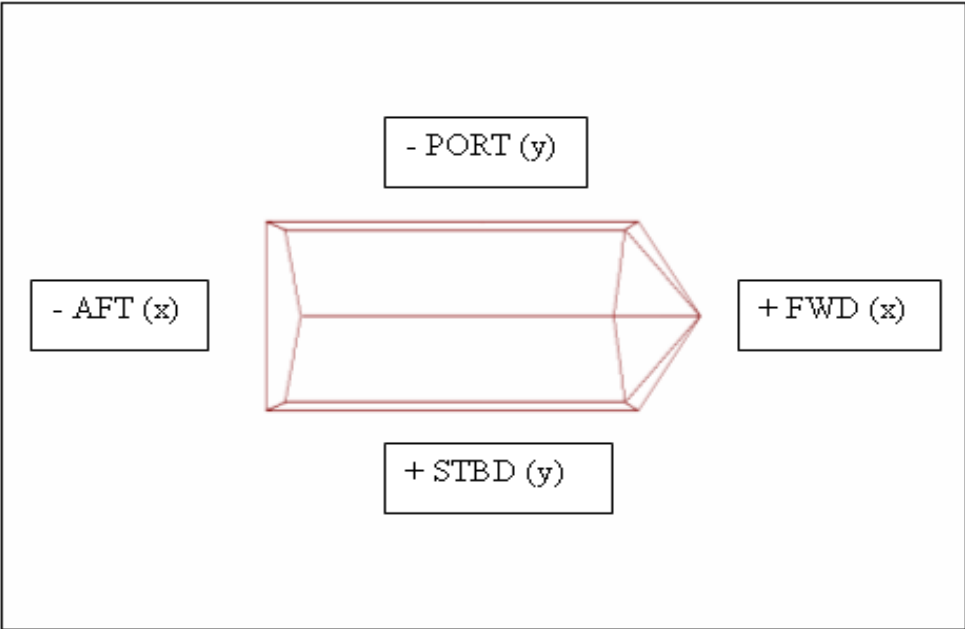
Bottom Center of IMU is origin of Westlake Coordinate System

## NGS Coordinate System



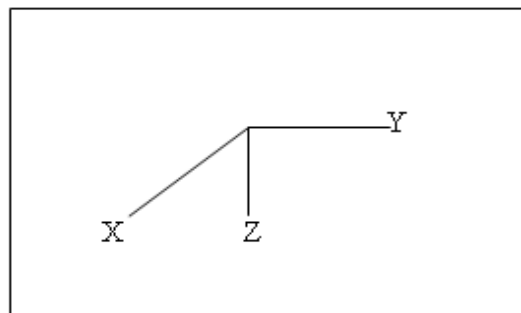
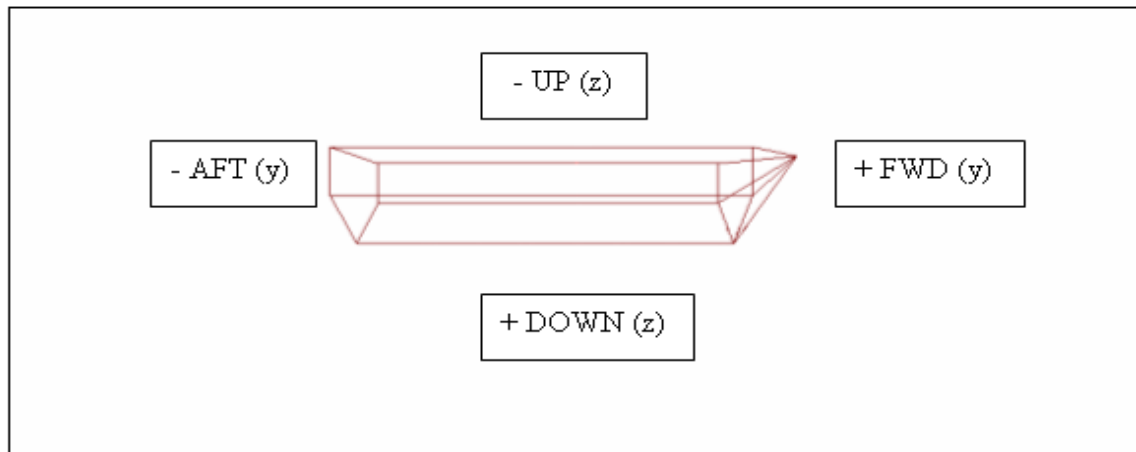
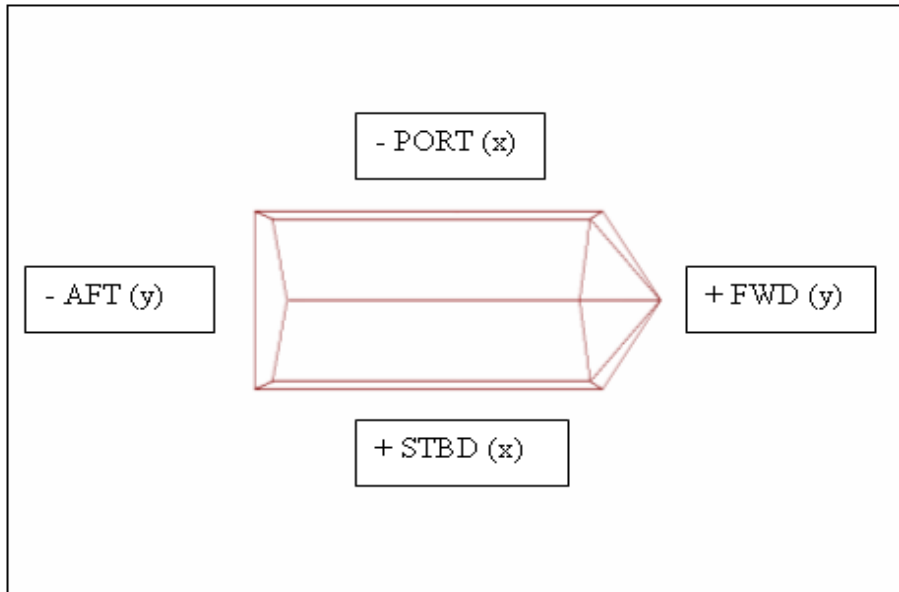
*Top Center of IMU is origin of NGS Coordinate System*

### POS/MV Coordinate System



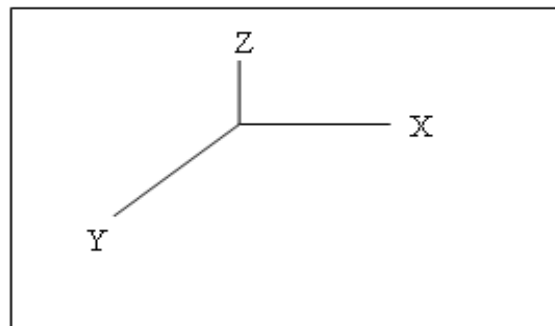
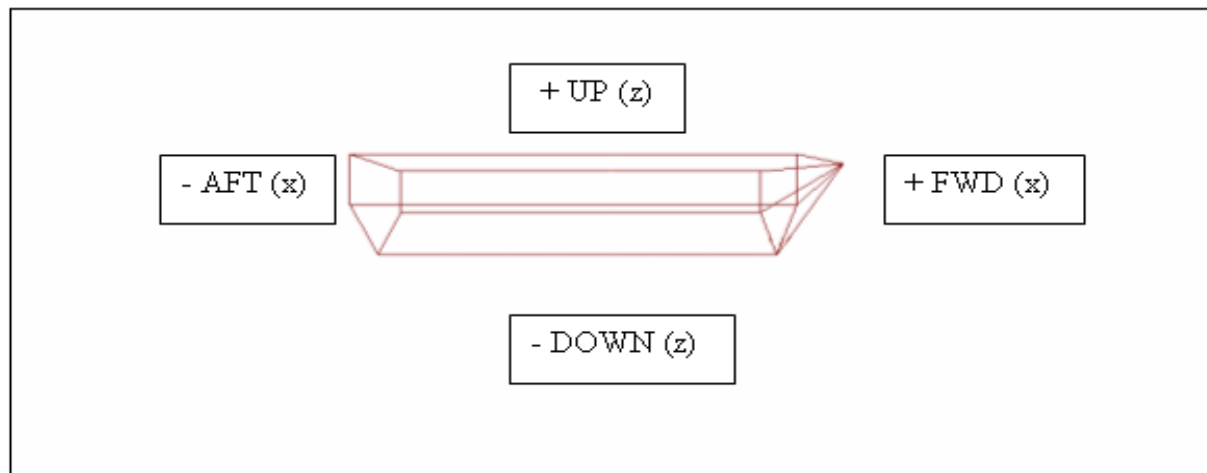
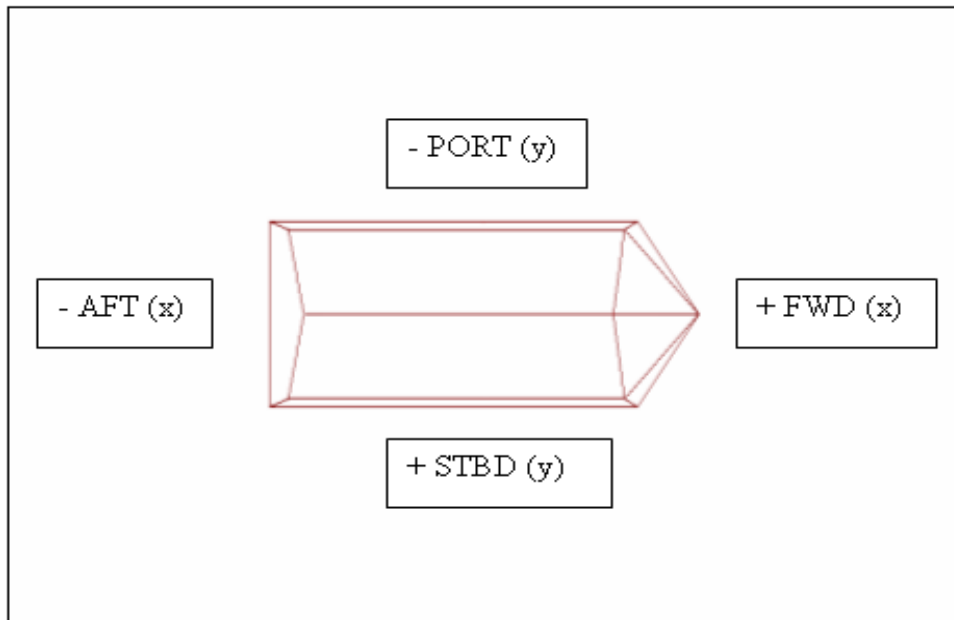
Top Center of IMU is origin of POS/MV Coordinate System

### CARIS Coordinate System



Top Center of IMU is origin of CARIS Coordinate System

## Theodolite Coordinate System



Benchmark C is the origin of the Theodolite Coordinate System

---



## Appendix IV

---

### Total Propagated Error / Uncertainty (TPE/TPU)

- Fairweather TPE/TPU Values
- Tide and Sound Speed TPE/TPU Values



**Tide and Sound Speed - Compute TPE (TPU) Values**

Project	Tide Measurement (Use in Caris)	Tide Zoning 95% (Provided by CO-OPS)	Tide Zoning 1-sigma (Use in Caris)		SV Msrd (m/s) (Use in Caris)	Surface SV (m/s) (Use in Caris)
OPR-O119-FA-09 Ernest Sound				8101	1.00	1.00
	0.00	0.14	0.07	8125	1.00	0.50
				8111/8160	0.50	0.50
OPR-P183-FA-09 Shumagin Islands and Vicinity				8101	1.00	1.00
	0.00	0.00	0.00	8125	1.00	0.50
	(TCARI is a special case, see FOO for more info)			8111/8160	0.50	0.50
OPR-P357-FA-09 Kachemak bay				8101	1.00	1.00
	0.00	0.13	0.065	8125	1.00	0.50
				8111/8160	0.50	0.50
OPR-P132-FA-09 PWS				8101	1.00	1.00
	0.00	0.31	0.155	8125	1.00	0.50
				8111/8160	0.50	0.50
OPR-O351_FA-09 Glacier Bay				8101	1.00	1.00
	0.01		0.2	7125/8125	1.00	0.50
				7111/8111/8160	0.50	0.50
S-O927-FA-09 Hawk Inlet				8101	1.00	1.00
	0.00	0.12	0.06	7125/8125	1.00	0.50
				7111/8111/8160	0.50	0.50

## Appendix V

---

### Additional Calibration Reports

- Control
- Diver Least Depth Gauge
- Laser Level
- Leadlines
- Sound Velocity
- Total Stations

## Vertical Control Equipment Test April 2009

The 2009 test of the *Fairweathers'* vertical control equipment included testing five 8210 Sutron “bubbler” Tide Gauges that were provided by the Center for Operational Oceanographic Products and Services (CO-OPS). The gauges are equipped with Paros Scientific Sensors (SDI-12) for measuring pressure. Each year, the gauges are checked by the CO-OPS Field Operations Center to ensure their accuracy.

CO-OPS does not provide calibration or quality assurance documentation to the FAIRWEATHER. FAIRWEATHER personnel are responsible for installation and removal of the water level gauges. CO-OPS is responsible for delivering final approved vertical correctors to the FAIRWEATHER for application to the hydrographic data set. As FAIRWEATHER receives new gauges, data quality assurance checks will be conducted in a similar manner as the procedures listed below to ensure full functionality prior to deployment.

Five tide gauges: #10 (3344973C), #12 (3344B1D0), #13 (3344C740), #14 (3344D436) and #17 (3351E1F2) were set up and tested by ship personnel at the Sand Point Pier in Seattle, WA from April 1st through April 17<sup>th</sup>, 2009. Each gauge was tested for at least 48 hours to insure proper data collection. The orifice was placed just off the pier by the gauge in approximately 10 meters of water. The GPS antenna was facing open sky to the South-Southwest. The set-up was periodically checked to insure proper transmission and to check for any leaks in the system. Table #1 below lists pertinent information for the five gauges tested at Sand Point.

CO-OPS was able to verify that all the above gauges had strong transmissions to the GOES satellite, and were collecting accurate tide curves.

<b>Gauge #</b>	<b>PAROS Ser#</b>	<b>GOES Channel</b>	<b>Plat ID</b>	<b>Tx Time</b>
<b>10</b>	<b>97043</b>	<b>116</b>	<b>3344973C</b>	<b>0:37:32</b>
<b>12</b>	<b>85173</b>	<b>116</b>	<b>3344B1D0</b>	<b>0:17:02</b>
<b>13</b>	<b>85220</b>	<b>116</b>	<b>3344C740</b>	<b>0:20:02</b>
<b>14</b>	<b>86002</b>	<b>116</b>	<b>3344D436</b>	<b>0:23:32</b>
<b>17</b>	<b>79049</b>	<b>116</b>	<b>3351E1F2</b>	<b>0:18:02</b>

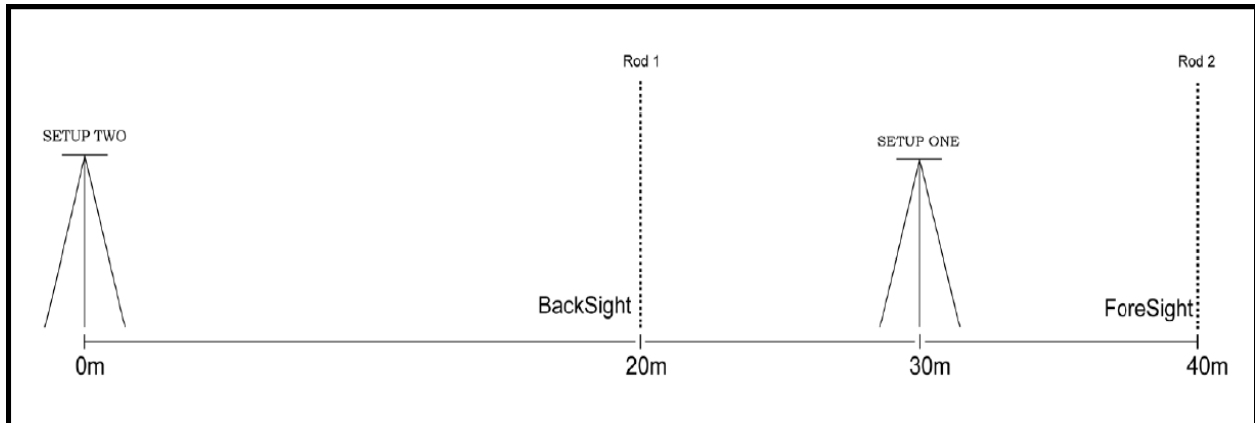
**Table 1: 2009 Gauge information**

## **Kukkamake February 26, 2009 (Dn 057)**

On February 26, 2009 (Dn 057) SST Campbell, ENS Forney, AST Renoud and AST Beduhn performed a Kukkamaki on both Carl Zeiss N12 (Stadia:333) levels (S/N 100056 and S/N 103267). The Kukkamaki were performed in conjunction with the Tides Training portion of Hydroschool 2009 at Sand Point.

The Kukkamaki course was set up in the parking lot on Lake Washington behind the Dive Building. The weather was sunny and cold with moderate wind. A 40 meter straight line was measured on level ground and divided into 10 meter intervals. The level was then set on the 30 meter mark and a backsight and foresight were shot to the 20 and 40 meter marks respectively. Next the level was set up at the 0 meter mark, and a backsight and foresight were shot to the 20 and 40 meter marks, respectively. (See Fig. 1)

The Carl Zeiss level, S/N 100056 had a collimation error of 0.026, and Zeiss level S/N 103267 also had a collimation error of 0.026. Error values for both Zeiss levels fall within the  $\pm 0.05$  tolerance requirements of the *Field Procedures Manual, May 2008*.



***Fig 1. Diagram of Kukkamaki setup***

NOAA FORM 75-29		U.S. DEPARTMENT OF COMMERCE				HSRR				103267		SHEET		OF			
(12-75)		NATIONAL OCEANIC AND ATMOSPHERIC ADMINISTRATION															
PRECISE LEVELING						FROM B.M.				TO B.M.							
THREE-WIRE						Kukkamaki				9:30		DATE: Dn 057, Feb. 26, 2009					
FORWARD RUN (See reverse for BACKWARD RUN)						WEATHER Sunny, cool											
BACKSIGHTS						FORESIGHTS				__3__ ORDER, CLASS __1__							
Setup	THREAD READING	MEAN	THREAD INTERVAL	SUM OF INTERVALS	ROD TEMP	THREAD READING	MEAN	THREAD INTERVAL	SUM OF INTERVALS	REMARKS							
	1548	BS1				1499	FS1			C = $(\Delta h1 - \Delta 2) - 0.2mm$							
1	1532	1532.33				1484	1483.67			20 m							
	1517					1468				where BS1 - FS1 = $\Delta h1$							
	4597					4451				BS2 - FS2 = $\Delta h2$							
	1411	20mS				1393	40mS			$\Delta h1 -$		48.67					
2	1381	1380.67				1331	1331.67			$\Delta h2$		49					
	1350					1271				$\Delta h1 - \Delta h2 =$		-0.33					
	4142					3995				- 0.2 (CR)		-0.53					
										$\pm 20m$		-0.02666667					
										C =		-0.02666667					
Fill in YELLOW shaded cells.												"C" must be < + 0.05mm/m					
												Instrument SN: 103267					
												Rod SN: B					
												Party Chief: Baird					
												Observer: SST Campbell					
												Recorder: ENS Forney					
												Rod Person: AST Renoud					

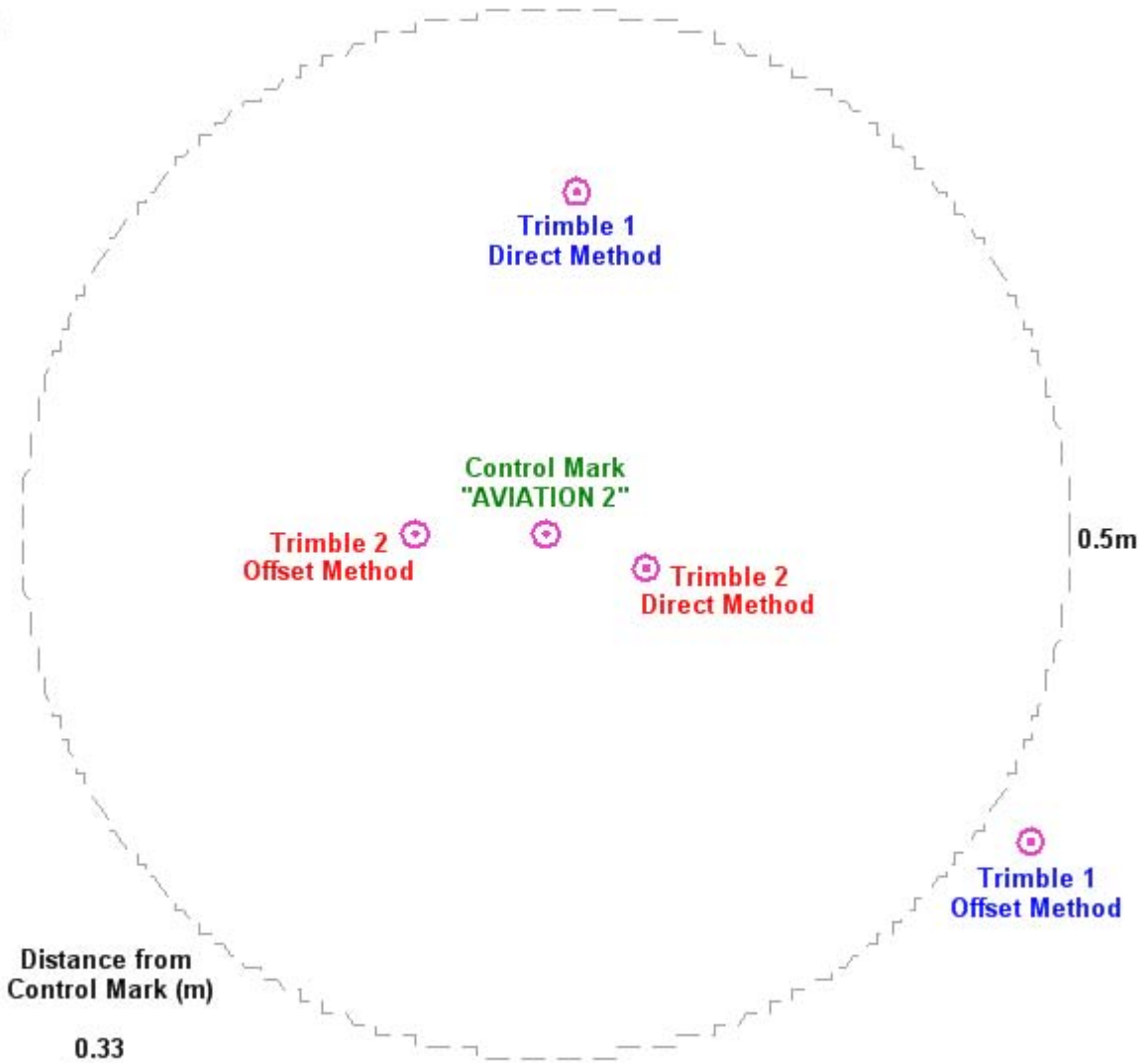




# NOAA Ship FAIRWEATHER

## Trimble Backpack Data Quality Assurance Testing

April 2009



Distance from  
Control Mark (m)

Trimble 1 Direct	0.33
Trimble 1 Offset	0.56
Trimble 2 Direct	0.10
Trimble 2 Offset	0.13

# SURVEY DATASHEET (Version 1.0)

**PID:** BBBK46  
**Designation:** VIXEN HBR 2009  
**Stamping:** VIXEN HBR 2009  
**Stability:**  
**Setting:** In rock outcrop or ledge  
**Description:** A modified 3.5 inch bronze NOS disk is cemented into a rock outcrop on the West Side of Magnetic Point on the eastern side of Ernest Sound. The mark is approximately 10 feet above the high water mark on the south side of the westward of two humps, and it protrudes south out of a wooded area and is nearly surrounded at high water. This mark was leveled as part of a series of NOS benchmarks for a tide station originally designated as Vixen Harbor.  
**Observed:** 2009-05-20T08:00:00Z  
**Source:** OPUS - page5 0810.20

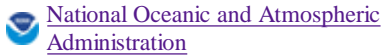


**Close-up View**

<b>REF_FRAME:</b> NAD_83(CORS96)	<b>EPOCH:</b> 2003.0000	<b>SOURCE:</b> NAVD88 (Computed using GEOID06)	<b>UNITS:</b> m	<b>SET PROFILE</b>	<b>DETAILS</b>
<b>LAT:</b> 55° 47' 18.23740" ± 0.005 m <b>LON:</b> -132° 11' 27.06511" ± 0.010 m <b>ELL HT:</b> 1.331 ± 0.015 m <b>X:</b> -2413974.145 ± 0.004 m <b>Y:</b> -2663096.964 ± 0.015 m <b>Z:</b> 5251232.937 ± 0.011 m <b>ORTHO HT:</b> 5.768 ± 0.121 m			<b>UTM 8      SPC 5001(AK 1 )</b> <b>NORTHING:</b> 6186101.208m 441196.443m <b>EASTING:</b> 676130.571m 911250.506m <b>CONVERGENCE:</b> 2.32366467° 1.22996338° <b>POINT SCALE:</b> 0.99998052 0.99990050 <b>COMBINED FACTOR:</b> 0.99998032 0.00000000		

**CONTRIBUTED BY**

[glen.rice](mailto:glen.rice)



**Horizon View**



Map data ©2009 Tele Atlas - [Terms of Use](#)

The numerical values for this position solution have satisfied the quality control criteria of the National Geodetic Survey. The contributor has verified that the information submitted is accurate and complete.



BASE STATION INFORMATION

STATION NAME: bis5 a 2 (Biorka Island 5; Biorka Island, Alaska USA)

MONUMENT: NO DOMES NUMBER

XYZ	-2494921.0833	-2448390.9914	5317113.6533	MON @ 1997.0000 (M)
XYZ	-0.0164	0.0037	0.0005	VEL (M/YR)
NEU	0.0000	0.0000	0.0000	MON TO ARP (M)
NEU	-0.0034	-0.0019	0.0813	ARP TO L1 PHASE CENTER (M)
NEU	-0.0037	-0.0015	0.0689	ARP TO L2 PHASE CENTER (M)
XYZ	-0.2022	0.0456	0.0062	VEL TIMES 12.3286 YRS
XYZ	0.0000	0.0000	0.0000	MON TO ARP
XYZ	-0.0351	-0.0318	0.0662	ARP TO L1 PHASE CENTER
XYZ	-2494921.3206	-2448390.9776	5317113.7257	L1 PHS CEN @ 2009.3286
XYZ	0.0000	0.0001	0.0001	+ XYZ ADJUSTMENTS
XYZ	-2494921.3205	-2448390.9775	5317113.7257	NEW L1 PHS CEN @ 2009.3286
XYZ	-2494921.2855	-2448390.9457	5317113.6595	NEW ARP @ 2009.3286
XYZ	-2494921.2855	-2448390.9457	5317113.6595	NEW MON @ 2009.3286
LLH	56 51 16.17152	224 27 38.53076	66.8349	NEW L1 PHS CEN @ 2009.3286
LLH	56 51 16.17163	224 27 38.53088	66.7536	NEW ARP @ 2009.3286
LLH	56 51 16.17163	224 27 38.53088	66.7536	NEW MON @ 2009.3286

STATION NAME: lev6 a 2 (Level Island 6; Level Island, Alaska USA)

MONUMENT: NO DOMES NUMBER

XYZ	-2412812.0457	-2579074.2577	5293282.2476	MON @ 1997.0000 (M)
XYZ	-0.0190	0.0003	-0.0044	VEL (M/YR)
NEU	0.0000	0.0000	0.0000	MON TO ARP (M)
NEU	-0.0034	-0.0019	0.0813	ARP TO L1 PHASE CENTER (M)
NEU	-0.0037	-0.0015	0.0689	ARP TO L2 PHASE CENTER (M)
XYZ	-0.2342	0.0037	-0.0542	VEL TIMES 12.3286 YRS
XYZ	0.0000	0.0000	0.0000	MON TO ARP
XYZ	-0.0340	-0.0336	0.0659	ARP TO L1 PHASE CENTER
XYZ	-2412812.3140	-2579074.2876	5293282.2592	L1 PHS CEN @ 2009.3286
XYZ	-0.0000	0.0000	0.0000	+ XYZ ADJUSTMENTS
XYZ	-2412812.3140	-2579074.2875	5293282.2593	NEW L1 PHS CEN @ 2009.3286
XYZ	-2412812.2799	-2579074.2540	5293282.1934	NEW ARP @ 2009.3286
XYZ	-2412812.2799	-2579074.2540	5293282.1934	NEW MON @ 2009.3286
LLH	56 27 56.37385	226 54 27.40784	25.4801	NEW L1 PHS CEN @ 2009.3286
LLH	56 27 56.37396	226 54 27.40796	25.3988	NEW ARP @ 2009.3286
LLH	56 27 56.37396	226 54 27.40796	25.3988	NEW MON @ 2009.3286

STATION NAME: ais5 a 2 (Annette Island 5; Annette Island, Alaska USA)

MONUMENT: NO DOMES NUMBER

XYZ	-2430153.8469	-2737192.9494	5205816.7670	MON @ 1997.0000 (M)
XYZ	-0.0147	-0.0013	-0.0087	VEL (M/YR)
NEU	0.0000	0.0000	0.0000	MON TO ARP (M)
NEU	-0.0034	-0.0019	0.0813	ARP TO L1 PHASE CENTER (M)
NEU	-0.0037	-0.0015	0.0689	ARP TO L2 PHASE CENTER (M)
XYZ	-0.1812	-0.0160	-0.1073	VEL TIMES 12.3286 YRS
XYZ	0.0000	0.0000	0.0000	MON TO ARP
XYZ	-0.0342	-0.0356	0.0647	ARP TO L1 PHASE CENTER
XYZ	-2430154.0623	-2737193.0011	5205816.7244	L1 PHS CEN @ 2009.3286
XYZ	0.0000	-0.0000	-0.0000	+ XYZ ADJUSTMENTS
XYZ	-2430154.0623	-2737193.0011	5205816.7244	NEW L1 PHS CEN @ 2009.3286
XYZ	-2430154.0281	-2737192.9654	5205816.6597	NEW ARP @ 2009.3286
XYZ	-2430154.0281	-2737192.9654	5205816.6597	NEW MON @ 2009.3286
LLH	55 4 8.65794	228 24 1.66886	32.4119	NEW L1 PHS CEN @ 2009.3286
LLH	55 4 8.65805	228 24 1.66897	32.3306	NEW ARP @ 2009.3286
LLH	55 4 8.65805	228 24 1.66897	32.3306	NEW MON @ 2009.3286

REMOTE STATION INFORMATION

STATION NAME: vixe 1  
 MONUMENT: NO DOMES NUMBER  
 XYZ -2413975.4955 -2663095.9246 5251234.3436 MON @ 2009.3281 (M)  
 NEU 0.0025 0.0026 1.3000 MON TO ARP (M)  
 NEU -0.0025 -0.0026 0.0637 ARP TO L1 PHASE CENTER (M)  
 NEU -0.0012 0.0008 0.0440 ARP TO L2 PHASE CENTER (M)  
 XYZ -0.4876 -0.5418 1.0765 MON TO ARP  
 XYZ -0.0274 -0.0263 0.0513 ARP TO L1 PHASE CENTER  
 XYZ -2413976.0104 -2663096.4927 5251235.4713 L1 PHS CEN @ 2009.3286

BASELINE NAME: bis5 vixe  
 XYZ 0.4944 0.0601 -1.2254 + XYZ ADJUSTMENTS  
 XYZ -2413975.5160 -2663096.4326 5251234.2459 NEW L1 PHS CEN @ 2009.3286  
 XYZ -2413975.4887 -2663096.4063 5251234.1947 NEW ARP @ 2009.3286  
 XYZ -2413975.0011 -2663095.8645 5251233.1182 NEW MON @ 2009.3286  
 LLH 55 47 18.24711 227 48 32.85611 2.7099 NEW L1 PHS CEN @ 2009.3286  
 LLH 55 47 18.24719 227 48 32.85626 2.6462 NEW ARP @ 2009.3286  
 LLH 55 47 18.24711 227 48 32.85611 1.3462 NEW MON @ 2009.3286

BASELINE NAME: lev6 vixe  
 XYZ 0.4956 0.0484 -1.2118 + XYZ ADJUSTMENTS  
 XYZ -2413975.5149 -2663096.4443 5251234.2595 NEW L1 PHS CEN @ 2009.3286  
 XYZ -2413975.4875 -2663096.4180 5251234.2082 NEW ARP @ 2009.3286  
 XYZ -2413974.9999 -2663095.8762 5251233.1318 NEW MON @ 2009.3286  
 LLH 55 47 18.24714 227 48 32.85661 2.7255 NEW L1 PHS CEN @ 2009.3286  
 LLH 55 47 18.24722 227 48 32.85676 2.6618 NEW ARP @ 2009.3286  
 LLH 55 47 18.24714 227 48 32.85661 1.3618 NEW MON @ 2009.3286

BASELINE NAME: ais5 vixe  
 XYZ 0.4596 0.0195 -1.1652 + XYZ ADJUSTMENTS  
 XYZ -2413975.5509 -2663096.4732 5251234.3062 NEW L1 PHS CEN @ 2009.3286  
 XYZ -2413975.5235 -2663096.4468 5251234.2549 NEW ARP @ 2009.3286  
 XYZ -2413975.0359 -2663095.9051 5251233.1784 NEW MON @ 2009.3286  
 LLH 55 47 18.24677 227 48 32.85619 2.7897 NEW L1 PHS CEN @ 2009.3286  
 LLH 55 47 18.24685 227 48 32.85634 2.7260 NEW ARP @ 2009.3286  
 LLH 55 47 18.24677 227 48 32.85619 1.4260 NEW MON @ 2009.3286

G-FILES

Axx2009 430 9 5 1  
 B2009 4301828 9 5 1 235 1 page5 v0810.20IGS 226 1 2 27NGS 2009 5 6IFDDFX  
 Iant\_info.003 NGS 20090501  
 C00090001 -809462844 24 2147049188 30 658805413 33 X1209AVIXEX1209ABIS5  
 D 1 2 4808077 1 3 -9110619 2 3 -5412684

Axx2009 430 9 5 1  
 B2009 4301828 9 5 1 235 1 page5 v0810.20IGS 226 1 2 27NGS 2009 5 6IFDDFX  
 Iant\_info.003 NGS 20090501  
 C00090002 11627200 25 840216222 34 420490616 38 X1209AVIXEX1209ALEV6  
 D 1 2 6906117 1 3 -8609405 2 3 -3610684

Axx2009 430 9 5 1  
 B2009 4301828 9 5 1 235 1 page5 v0810.20IGS 226 1 2 27NGS 2009 5 6IFDDFX  
 Iant\_info.003 NGS 20090501  
 C00090003 -161789922 38 -740970604 54 -454165187 57 X1209AVIXEX1209AAIS5  
 D 1 2 7937919 1 3 -6704252 2 3 -1704411

POST-FIT RMS BY SATELLITE VS. BASELINE

	OVERALL	02	03	04	06	07	08	09	10
bis5-vixe	0.015	0.022	0.059	0.016	...	0.015	0.014	...	0.018
	11	12	13	14	16	17	18	19	20
bis5-vixe	0.011	...	0.017	0.014	0.018	0.017	...	0.017	0.014
	22	23	24	25	28	30	31	32	
bis5-vixe	0.018	0.013	...	0.015	0.022	...	0.018	0.020	

	OVERALL	01	02	03	04	06	07	08	09
lev6-vixe	0.015	...	0.018	0.001	0.016	...	0.015	0.014	...
	10	11	12	13	14	16	17	18	19
lev6-vixe	0.018	0.012	...	0.016	0.014	0.013	0.018	...	0.019
	20	22	23	24	25	28	30	31	32
lev6-vixe	0.014	0.019	0.014	...	0.015	...	...	0.019	...

	OVERALL	02	03	04	06	07	08	09	10
ais5-vixe	0.017	0.025	0.008	0.021	...	0.014	0.016	...	0.020
	11	12	13	14	16	17	18	19	20
ais5-vixe	0.013	...	0.021	0.015	0.012	0.022	...	0.019	0.022
	22	23	24	25	28	30	31	32	
ais5-vixe	0.021	0.016	...	0.015	0.022	...	0.017	0.019	

OBS BY SATELLITE VS. BASELINE

	OVERALL	02	03	04	06	07	08	09	10
bis5-vixe	5152	289	1	375	...	421	269	...	246
	11	12	13	14	16	17	18	19	20
bis5-vixe	389	...	191	220	9	247	...	139	608
	22	23	24	25	28	30	31	32	
bis5-vixe	110	642	...	531	61	...	385	19	
	OVERALL	01	02	03	04	06	07	08	09
lev6-vixe	4998	...	252	1	380	...	427	254	...
	10	11	12	13	14	16	17	18	19
lev6-vixe	234	399	...	196	221	8	262	...	137
	20	22	23	24	25	28	30	31	32
lev6-vixe	584	110	612	...	523	...	...	398	...
	OVERALL	02	03	04	06	07	08	09	10
ais5-vixe	4628	151	1	314	...	411	234	...	209
	11	12	13	14	16	17	18	19	20
ais5-vixe	384	...	163	221	8	151	...	108	566
	22	23	24	25	28	30	31	32	
ais5-vixe	112	616	...	523	48	...	390	18	

Covariance Matrix for the xyz OPUS Position (meters<sup>2</sup>).

```

0.0000058778    0.0000005693   -0.0000006648
0.0000005693    0.0000110489   -0.0000003393
-0.0000006648   -0.0000003393    0.0000128489
    
```

Covariance Matrix for the enu OPUS Position (meters<sup>2</sup>).

```

0.0000076436   -0.0000022269    0.0000012035
-0.0000022269    0.0000097701    0.0000014095
0.0000012035    0.0000014095    0.0000123618
    
```

Horizontal network accuracy = 0.00730 meters.

Vertical network accuracy = 0.00689 meters.

Derivation of NAD 83 vector components

Position of reference station ARP in NAD\_83(CORS96)(EPOCH:2003.0000).

	Xa(m)	Ya(m)	Za(m)	
BIS5	-2494920.44060	-2448392.05858	5317113.38841	2003.00
LEV6	-2412811.42529	-2579075.35282	5293281.97185	2003.00
AIS5	-2430153.20716	-2737194.06415	5205816.48535	2003.00

Position of reference station monument in NAD\_83(CORS96)(EPOCH:2003.0000).

	Xr(m)	Yr(m)	Zr(m)	
BIS5	-2494920.44060	-2448392.05858	5317113.38841	2003.00
LEV6	-2412811.42529	-2579075.35282	5293281.97185	2003.00
AIS5	-2430153.20716	-2737194.06415	5205816.48535	2003.00

Velocity of reference station monument in NAD\_83(CORS96)(EPOCH:2003.0000).

	Vx (m/yr)	Vy (m/yr)	Vz (m/yr)
BIS5	0.00490	0.00450	0.00990
LEV6	0.00220	0.00120	0.00480
AIS5	0.00620	-0.00040	0.00060

Vectors from unknown station monument to reference station monument in NAD\_83(CORS96)(EPOCH:2003.0000).

	Xr-X= DX(m)	Yr-Y= DY(m)	Zr-Z= DZ(m)	
BIS5	-80946.27660	214704.92342	65880.42141	2003.00
LEV6	1162.73871	84021.62918	42049.00485	2003.00
AIS5	-16179.04316	-74097.08215	-45416.48165	2003.00

This position and the above vector components were computed without any knowledge by the National Geodetic Survey regarding the equipment or field operating procedures used.





AI4914  
 AI4914! - Elev Factor x Scale Factor = Combined Factor  
 AI4914!SPC AK 1 - 0.99999941 x 0.99990058 = 0.99989999  
 AI4914!UTM 09 - 0.99999941 x 0.99994023 = 0.99993964  
 AI4914  
 AI4914 SUPERSEDED SURVEY CONTROL  
 AI4914  
 AI4914 NAD 83(1992)- 55 19 58.65991(N) 131 37 31.82053(W) AD( ) B  
 AI4914 ELLIP H (04/28/00) 3.819 (m) GP( ) 4 1  
 AI4914  
 AI4914.Superseded values are not recommended for survey control.  
 AI4914.NGS no longer adjusts projects to the NAD 27 or NGVD 29 datums.  
 AI4914.[See file dsdata.txt](#) to determine how the superseded data were derived.  
 AI4914  
 AI4914\_U.S. NATIONAL GRID SPATIAL ADDRESS: 9UUB3346434983(NAD 83)  
 AI4914\_MARKER: DB = BENCH MARK DISK  
 AI4914\_SETTING: 32 = SET IN A RETAINING WALL OR CONCRETE LEDGE  
 AI4914\_SP\_SET: RETAINING WALL  
 AI4914\_STAMPING: NO 37 1956  
 AI4914\_MARK LOGO: CGS  
 AI4914\_MAGNETIC: O = OTHER; SEE DESCRIPTION  
 AI4914\_STABILITY: B = PROBABLY HOLD POSITION/ELEVATION WELL  
 AI4914\_SATELLITE: THE SITE LOCATION WAS REPORTED AS SUITABLE FOR  
 AI4914+SATELLITE: SATELLITE OBSERVATIONS - January 04, 2007  
 AI4914  

AI4914 HISTORY	- Date	Condition	Report By
AI4914 HISTORY	- 1956	MONUMENTED	CGS
AI4914 HISTORY	- 20050420	GOOD	NGS
AI4914 HISTORY	- 20070104	GOOD	INDIV

 AI4914  
 AI4914 STATION DESCRIPTION  
 AI4914  
 AI4914'DESCRIBED BY COAST AND GEODETIC SURVEY 1956  
 AI4914'DESCRIBED BY R+M CONSULTANTS 1999 (RHB) . THE STATION IS LOCATED  
 AI4914'APPROXIMATELY 1.6 KM (1.00 MI) SOUTHEASTERLY OF DOWNTOWN KETCHIKAN  
 AI4914'ALASKA AT THE KETCHIKAN COAST GUARD BASE. OWNERSHIP-- UNITED STATES  
 AI4914'COAST GUARD, C/O PCC CHUCK SHAFFER I.S.C. KETCHIKAN, 1300 STEDMAN  
 AI4914'STREET, KETCHIKAN ALASKA 99901, PHONE NUMBER 907-228-0380, FAX NUMBER  
 AI4914'907-228-0314, ACCESS IS RESTRICTED. CONTACT THE CHIEF PETTY OFFICER  
 AI4914'AT LEAST 48 HOURS PRIOR TO ENTRY.  
 AI4914'TO REACH THE STATION FROM THE INTERSECTION OF STEDMAN STREET AND  
 AI4914'DEERMOUNT STREET, AT THE SOUTHEASTERLY END OF KETCHIKAN, PROCEED  
 AI4914'SOUTHEAST 1.0 KM (0.60 MI) ALONG STEDMAN STREET TO THE COAST GUARD  
 AI4914'BASE AND THE STATION ON THE RIGHT.  
 AI4914'THE STATION IS A STANDARD USCGS BRASS BENCH MARK DISK STAMPED --NO 37  
 AI4914'1956-- AND SET FLUSH WITH A CONCRETE RETAINING WALL IN FRONT OF THE  
 AI4914'COAST GUARD ADMINISTRATION BUILDING. THE STATION IS LOCATED 26.5 M  
 AI4914'(86.9 FT) 351 DEGREES MAGNETIC AZIMUTH FROM THE NORTHEAST CORNER OF  
 AI4914'THE COAST GUARD ADMINISTRATION BUILDING, 3.0 M (9.8 FT) 134 DEGREES  
 AI4914'MAGNETIC AZIMUTH FROM THE NORTH END OF A GUARD RAIL, AND 42.2 M (138.5  
 AI4914'FT) 95 DEGREES MAGNETIC AZIMUTH FROM A FIRE HYDRANT.  
 AI4914  
 AI4914 STATION RECOVERY (2005)  
 AI4914  
 AI4914'RECOVERY NOTE BY NATIONAL GEODETIC SURVEY 2005 (RA)  
 AI4914'RECOVERED IN GOOD CONDITION.  
 AI4914  
 AI4914 STATION RECOVERY (2007)  
 AI4914  
 AI4914'RECOVERY NOTE BY INDIVIDUAL CONTRIBUTORS 2007 (JPP)  
 AI4914'RECOVERED AS DESCRIBED

\*\*\* retrieval complete.  
 Elapsed Time = 00:00:00

NGS OPUS SOLUTION REPORT  
=====

All computed coordinate accuracies are listed as peak-to-peak values.  
For additional information: [www.ngs.noaa.gov/OPUS/Using\\_OPUS.html#accuracy](http://www.ngs.noaa.gov/OPUS/Using_OPUS.html#accuracy)

USER: weston.renoud@noaa.gov  
RINEX FILE: uscg121u.09o

DATE: May 06, 2009  
TIME: 01:51:09 UTC

SOFTWARE: page5 0810.20 master30.pl 081023      START: 2009/05/01 20:56:00  
EPHEMERIS: igr15295.eph [rapid]                    STOP: 2009/05/01 23:05:00  
NAV FILE: brdc1210.09n                            OBS USED: 4299 / 4471 : 96%  
ANT NAME: ASH701975.01AGP NONE                 # FIXED AMB: 25 / 28 : 89%  
ARP HEIGHT: 1.5                                    OVERALL RMS: 0.016(m)

REF FRAME: NAD\_83(CORS96)(EPOCH:2003.0000)                    ITRF00 (EPOCH:2009.3313)

X:        -2415358.948(m)    0.060(m)                    -2415359.797(m)    0.060(m)  
Y:        -2718046.293(m)    0.089(m)                    -2718045.189(m)    0.089(m)  
Z:            5222559.332(m)    0.048(m)                    5222559.513(m)    0.048(m)

LAT:        55 19 58.65822            0.078(m)                    55 19 58.66849            0.078(m)  
E LON:        228 22 28.18196            0.066(m)                    228 22 28.10437            0.066(m)  
W LON:        131 37 31.81804            0.066(m)                    131 37 31.89563            0.066(m)  
EL HGT:            3.872(m)    0.058(m)                    3.872(m)    0.058(m)  
ORTHO HGT:            9.747(m)    0.133(m) [NAVD88 (Computed using GEOID06)]

	UTM COORDINATES	STATE PLANE COORDINATES
	UTM (Zone 09)	SPC (5001 AK 1)
Northing (Y) [meters]	6134983.124	391423.761
Easting (X) [meters]	333464.496	948202.701
Convergence [degrees]	-2.15989498	1.69678539
Point Scale	0.99994023	0.99990058
Combined Factor	0.99993962	0.00000000

US NATIONAL GRID DESIGNATOR: 9UUB3346434983(NAD 83)

BASE STATIONS USED

PID	DESIGNATION	LATITUDE	LONGITUDE	DISTANCE(m)
DK6423	BIS5 BIORKA ISLAND 5 CORS ARP	N565116.162	W1353221.387	296620.9
DJ3035	LEV6 LEVEL ISLAND 6 CORS ARP	N562756.364	W1330532.511	155952.3
DK6482	AIS5 ANNETTE ISLAND 5 CORS ARP	N550408.647	W1313558.255	29425.0

NEAREST NGS PUBLISHED CONTROL POINT

AI4914	BM NO 37	N551958.661	W1313731.819	0.0
--------	----------	-------------	--------------	-----

BASE STATION INFORMATION

STATION NAME: bis5 a 2 (Biorka Island 5; Biorka Island, Alaska USA)  
 MONUMENT: NO DOMES NUMBER

XYZ	-2494921.0833	-2448390.9914	5317113.6533	MON @ 1997.0000 (M)
XYZ	-0.0164	0.0037	0.0005	VEL (M/YR)
NEU	0.0000	0.0000	0.0000	MON TO ARP (M)
NEU	-0.0034	-0.0019	0.0813	ARP TO L1 PHASE CENTER (M)
NEU	-0.0037	-0.0015	0.0689	ARP TO L2 PHASE CENTER (M)
XYZ	-0.2022	0.0456	0.0062	VEL TIMES 12.3313 YRS
XYZ	0.0000	0.0000	0.0000	MON TO ARP
XYZ	-0.0351	-0.0318	0.0662	ARP TO L1 PHASE CENTER
XYZ	-2494921.3206	-2448390.9775	5317113.7257	L1 PHS CEN @ 2009.3313
XYZ	-0.0000	-0.0000	-0.0000	+ XYZ ADJUSTMENTS
XYZ	-2494921.3206	-2448390.9776	5317113.7257	NEW L1 PHS CEN @ 2009.3313
XYZ	-2494921.2855	-2448390.9458	5317113.6595	NEW ARP @ 2009.3313
XYZ	-2494921.2855	-2448390.9458	5317113.6595	NEW MON @ 2009.3313
LLH	56 51 16.17151	224 27 38.53076	66.8349	NEW L1 PHS CEN @ 2009.3313
LLH	56 51 16.17162	224 27 38.53087	66.7536	NEW ARP @ 2009.3313
LLH	56 51 16.17162	224 27 38.53087	66.7536	NEW MON @ 2009.3313

STATION NAME: lev6 a 2 (Level Island 6; Level Island, Alaska USA)  
 MONUMENT: NO DOMES NUMBER

XYZ	-2412812.0457	-2579074.2577	5293282.2476	MON @ 1997.0000 (M)
XYZ	-0.0190	0.0003	-0.0044	VEL (M/YR)
NEU	0.0000	0.0000	0.0000	MON TO ARP (M)
NEU	-0.0034	-0.0019	0.0813	ARP TO L1 PHASE CENTER (M)
NEU	-0.0037	-0.0015	0.0689	ARP TO L2 PHASE CENTER (M)
XYZ	-0.2343	0.0037	-0.0543	VEL TIMES 12.3313 YRS
XYZ	0.0000	0.0000	0.0000	MON TO ARP
XYZ	-0.0340	-0.0336	0.0659	ARP TO L1 PHASE CENTER
XYZ	-2412812.3140	-2579074.2876	5293282.2592	L1 PHS CEN @ 2009.3313
XYZ	-0.0000	0.0000	-0.0000	+ XYZ ADJUSTMENTS
XYZ	-2412812.3140	-2579074.2876	5293282.2592	NEW L1 PHS CEN @ 2009.3313
XYZ	-2412812.2800	-2579074.2540	5293282.1933	NEW ARP @ 2009.3313
XYZ	-2412812.2800	-2579074.2540	5293282.1933	NEW MON @ 2009.3313
LLH	56 27 56.37384	226 54 27.40784	25.4801	NEW L1 PHS CEN @ 2009.3313
LLH	56 27 56.37395	226 54 27.40796	25.3988	NEW ARP @ 2009.3313
LLH	56 27 56.37395	226 54 27.40796	25.3988	NEW MON @ 2009.3313

STATION NAME: ais5 a 2 (Annette Island 5; Annette Island, Alaska USA)  
 MONUMENT: NO DOMES NUMBER

XYZ	-2430153.8469	-2737192.9494	5205816.7670	MON @ 1997.0000 (M)
XYZ	-0.0147	-0.0013	-0.0087	VEL (M/YR)
NEU	0.0000	0.0000	0.0000	MON TO ARP (M)
NEU	-0.0034	-0.0019	0.0813	ARP TO L1 PHASE CENTER (M)
NEU	-0.0037	-0.0015	0.0689	ARP TO L2 PHASE CENTER (M)
XYZ	-0.1813	-0.0160	-0.1073	VEL TIMES 12.3313 YRS
XYZ	0.0000	0.0000	0.0000	MON TO ARP
XYZ	-0.0342	-0.0356	0.0647	ARP TO L1 PHASE CENTER
XYZ	-2430154.0623	-2737193.0011	5205816.7244	L1 PHS CEN @ 2009.3313
XYZ	-0.0000	0.0000	-0.0000	+ XYZ ADJUSTMENTS
XYZ	-2430154.0623	-2737193.0011	5205816.7244	NEW L1 PHS CEN @ 2009.3313
XYZ	-2430154.0282	-2737192.9654	5205816.6597	NEW ARP @ 2009.3313
XYZ	-2430154.0282	-2737192.9654	5205816.6597	NEW MON @ 2009.3313
LLH	55 4 8.65794	228 24 1.66886	32.4119	NEW L1 PHS CEN @ 2009.3313
LLH	55 4 8.65805	228 24 1.66897	32.3306	NEW ARP @ 2009.3313
LLH	55 4 8.65805	228 24 1.66897	32.3306	NEW MON @ 2009.3313

REMOTE STATION INFORMATION

STATION NAME: uscg 1  
 MONUMENT: NO DOMES NUMBER  
 XYZ -2415360.6791 -2718045.9236 5222561.0525 MON @ 2009.3312 (M)  
 NEU 0.0025 0.0026 1.5000 MON TO ARP (M)  
 NEU -0.0025 -0.0026 0.0637 ARP TO L1 PHASE CENTER (M)  
 NEU -0.0012 0.0008 0.0440 ARP TO L2 PHASE CENTER (M)  
 XYZ -0.5634 -0.6380 1.2351 MON TO ARP  
 XYZ -0.0274 -0.0269 0.0510 ARP TO L1 PHASE CENTER  
 XYZ -2415361.2699 -2718046.5885 5222562.3386 L1 PHS CEN @ 2009.3313

BASELINE NAME: bis5 uscg  
 XYZ 0.9053 0.7027 -1.5713 + XYZ ADJUSTMENTS  
 XYZ -2415360.3646 -2718045.8858 5222560.7673 NEW L1 PHS CEN @ 2009.3313  
 XYZ -2415360.3372 -2718045.8589 5222560.7163 NEW ARP @ 2009.3313  
 XYZ -2415359.7738 -2718045.2209 5222559.4812 NEW MON @ 2009.3313  
 LLH 55 19 58.66769 228 22 28.10655 5.4148 NEW L1 PHS CEN @ 2009.3313  
 LLH 55 19 58.66777 228 22 28.10670 5.3511 NEW ARP @ 2009.3313  
 LLH 55 19 58.66769 228 22 28.10655 3.8511 NEW MON @ 2009.3313

BASELINE NAME: lev6 uscg  
 XYZ 0.8455 0.7092 -1.5248 + XYZ ADJUSTMENTS  
 XYZ -2415360.4245 -2718045.8793 5222560.8138 NEW L1 PHS CEN @ 2009.3313  
 XYZ -2415360.3971 -2718045.8524 5222560.7628 NEW ARP @ 2009.3313  
 XYZ -2415359.8336 -2718045.2144 5222559.5277 NEW MON @ 2009.3313  
 LLH 55 19 58.66761 228 22 28.10377 5.4730 NEW L1 PHS CEN @ 2009.3313  
 LLH 55 19 58.66769 228 22 28.10392 5.4093 NEW ARP @ 2009.3313  
 LLH 55 19 58.66761 228 22 28.10377 3.9093 NEW MON @ 2009.3313

BASELINE NAME: ais5 uscg  
 XYZ 0.8950 0.7912 -1.5237 + XYZ ADJUSTMENTS  
 XYZ -2415360.3749 -2718045.7973 5222560.8149 NEW L1 PHS CEN @ 2009.3313  
 XYZ -2415360.3476 -2718045.7704 5222560.7639 NEW ARP @ 2009.3313  
 XYZ -2415359.7841 -2718045.1324 5222559.5288 NEW MON @ 2009.3313  
 LLH 55 19 58.67014 228 22 28.10278 5.4202 NEW L1 PHS CEN @ 2009.3313  
 LLH 55 19 58.67022 228 22 28.10293 5.3565 NEW ARP @ 2009.3313  
 LLH 55 19 58.67014 228 22 28.10278 3.8565 NEW MON @ 2009.3313

G-FILES

Axx2009 5 1 9 5 1  
 B2009 5 12056 9 5 123 5 1 page5 v0810.20IGS 226 1 2 27NGS 2009 5 5IFDDFX  
 Iant\_info.003 NGS 20090501  
 C00090001 -795615118 66 2696542751 78 945541782 67 X1219AUSCGX1219ABIS5  
 D 1 2 2500896 1 3 -8353636 2 3 -3886207

Axx2009 5 1 9 5 1  
 B2009 5 12056 9 5 123 5 1 page5 v0810.20IGS 226 1 2 27NGS 2009 5 5IFDDFX  
 Iant\_info.003 NGS 20090501  
 C00090002 25475536 48 1389709604 61 707226656 63 X1219AUSCGX1219ALEV6  
 D 1 2 4114541 1 3 -8151359 2 3 -1359443

Axx2009 5 1 9 5 1  
 B2009 5 12056 9 5 123 5 1 page5 v0810.20IGS 226 1 2 27NGS 2009 5 5IFDDFX  
 Iant\_info.003 NGS 20090501  
 C00090003 -147942441 83 -191478330 77 -167428691 87 X1219AUSCGX1219AAIS5  
 D 1 2 9292636 1 3 -1168614 2 3 -2618

POST-FIT RMS BY SATELLITE VS. BASELINE

	OVERALL	02	04	07	11	13	14	16	17
bis5-uscg	0.020	0.025	0.019	...	0.017	0.025	...	0.028	...
	20	23	25	30	31	32			
bis5-uscg	...	0.019	0.028	...	0.016	0.018			
	OVERALL	02	04	07	11	13	14	16	17
lev6-uscg	0.012	0.022	0.015	...	0.014	0.012	...	0.029	...
	20	23	25	30	31	32			
lev6-uscg	...	0.011	0.013	...	0.010	0.010			
	OVERALL	02	04	07	11	13	14	16	17
ais5-uscg	0.015	0.026	0.019	...	0.016	0.020	...	0.024	...
	20	23	25	30	31	32			
ais5-uscg	...	0.012	0.018	...	0.012	0.012			

OBS BY SATELLITE VS. BASELINE

	OVERALL	02	04	07	11	13	14	16	17
bis5-uscg	1428	40	217	...	85	166	...	106	...
	20	23	25	30	31	32			
bis5-uscg	...	256	91	...	211	256			
	OVERALL	02	04	07	11	13	14	16	17
lev6-uscg	1441	27	221	...	85	166	...	131	...
	20	23	25	30	31	32			
lev6-uscg	...	252	91	...	212	256			
	OVERALL	02	04	07	11	13	14	16	17
ais5-uscg	1430	40	198	...	79	159	...	141	...
	20	23	25	30	31	32			
ais5-uscg	...	256	89	...	212	256			

Covariance Matrix for the xyz OPUS Position (meters<sup>2</sup>).

0.0000301089	0.0000018736	-0.0000015562
0.0000018736	0.0000349644	-0.0000005678
-0.0000015562	-0.0000005678	0.0000356156

Covariance Matrix for the enu OPUS Position (meters<sup>2</sup>).

0.0000303908	-0.0000022471	0.0000006067
-0.0000022471	0.0000336197	-0.000000685
0.0000006067	-0.000000685	0.0000366785

Horizontal network accuracy = 0.01384 meters.

Vertical network accuracy = 0.01188 meters.

Derivation of NAD 83 vector components

Position of reference station ARP in NAD\_83(CORS96)(EPOCH:2003.0000).

	Xa(m)	Ya(m)	Za(m)	
BIS5	-2494920.44060	-2448392.05858	5317113.38841	2003.00
LEV6	-2412811.42529	-2579075.35282	5293281.97185	2003.00
AIS5	-2430153.20716	-2737194.06415	5205816.48535	2003.00

Position of reference station monument in NAD\_83(CORS96)(EPOCH:2003.0000).

	Xr(m)	Yr(m)	Zr(m)	
BIS5	-2494920.44060	-2448392.05858	5317113.38841	2003.00
LEV6	-2412811.42529	-2579075.35282	5293281.97185	2003.00
AIS5	-2430153.20716	-2737194.06415	5205816.48535	2003.00

Velocity of reference station monument in NAD\_83(CORS96)(EPOCH:2003.0000).

	Vx (m/yr)	Vy (m/yr)	Vz (m/yr)
BIS5	0.00490	0.00450	0.00990
LEV6	0.00220	0.00120	0.00480
AIS5	0.00620	-0.00040	0.00060

Vectors from unknown station monument to reference station monument in NAD\_83(CORS96)(EPOCH:2003.0000).

	Xr-X= DX(m)	Yr-Y= DY(m)	Zr-Z= DZ(m)	
BIS5	-79561.49260	269654.23442	94554.05641	2003.00
LEV6	2547.52271	138970.94018	70722.63985	2003.00
AIS5	-14794.25916	-19147.77115	-16742.84665	2003.00

This position and the above vector components were computed without any knowledge by the National Geodetic Survey regarding the equipment or field operating procedures used.

FILE: 10541220.09o 000038259

NGS OPUS SOLUTION REPORT  
=====

All computed coordinate accuracies are listed as peak-to-peak values.  
For additional information: [www.ngs.noaa.gov/OPUS/Using\\_OPUS.html#accuracy](http://www.ngs.noaa.gov/OPUS/Using_OPUS.html#accuracy)

USER: weston.renoud@noaa.gov  
RINEX FILE: 1054122b.09o

DATE: May 06, 2009  
TIME: 05:56:23 UTC

SOFTWARE: page5 0810.20 master11.pl 081023      START: 2009/05/02 01:31:00  
EPHEMERIS: igr15296.eph [rapid]                    STOP: 2009/05/02 03:27:30  
NAV FILE: brdc1220.09n                            OBS USED: 4571 / 4715 : 97%  
ANT NAME: TRM55971.00                           # FIXED AMB: 28 / 29 : 97%  
ARP HEIGHT: 1.5                                   OVERALL RMS: 0.012(m)

REF FRAME: NAD\_83(CORS96) (EPOCH:2003.0000)                    ITRF00 (EPOCH:2009.3318)

X:        -2415358.872(m)    0.005(m)                    -2415359.721(m)    0.005(m)  
Y:        -2718046.148(m)    0.053(m)                    -2718045.044(m)    0.053(m)  
Z:        5222559.317(m)    0.036(m)                    5222559.498(m)    0.036(m)

LAT:      55 19 58.66217        0.038(m)                    55 19 58.67244        0.038(m)  
E LON:    228 22 28.17972        0.033(m)                    228 22 28.10212        0.033(m)  
W LON:    131 37 31.82028        0.033(m)                    131 37 31.89788        0.033(m)  
EL HGT:                    3.770(m)    0.037(m)                    3.770(m)    0.037(m)  
ORTHO HGT:                    9.645(m)    0.125(m) [NAVD88 (Computed using GEOID06)]

	UTM COORDINATES	STATE PLANE COORDINATES
	UTM (Zone 09)	SPC (5001 AK 1)
Northing (Y) [meters]	6134983.248	391423.882
Easting (X) [meters]	333464.461	948202.658
Convergence [degrees]	-2.15989552	1.69678487
Point Scale	0.99994023	0.99990058
Combined Factor	0.99993964	0.00000000

US NATIONAL GRID DESIGNATOR: 9UUB3346434983(NAD 83)

BASE STATIONS USED

PID	DESIGNATION	LATITUDE	LONGITUDE	DISTANCE(m)
DK6423	BIS5 BIORKA ISLAND 5 CORS ARP	N565116.162	W1353221.387	296620.7
DJ3035	LEV6 LEVEL ISLAND 6 CORS ARP	N562756.364	W1330532.511	155952.1
DK6482	AIS5 ANNETTE ISLAND 5 CORS ARP	N550408.647	W1313558.255	29425.1

NEAREST NGS PUBLISHED CONTROL POINT

AI4914	BM NO 37	N551958.661	W1313731.819	0.0
--------	----------	-------------	--------------	-----

BASE STATION INFORMATION

STATION NAME: bis5 a 2 (Biorka Island 5; Biorka Island, Alaska USA)  
 MONUMENT: NO DOMES NUMBER

XYZ	-2494921.0833	-2448390.9914	5317113.6533	MON @ 1997.0000 (M)
XYZ	-0.0164	0.0037	0.0005	VEL (M/YR)
NEU	0.0000	0.0000	0.0000	MON TO ARP (M)
NEU	-0.0034	-0.0019	0.0813	ARP TO L1 PHASE CENTER (M)
NEU	-0.0037	-0.0015	0.0689	ARP TO L2 PHASE CENTER (M)
XYZ	-0.2022	0.0456	0.0062	VEL TIMES 12.3318 YRS
XYZ	0.0000	0.0000	0.0000	MON TO ARP
XYZ	-0.0351	-0.0318	0.0662	ARP TO L1 PHASE CENTER
XYZ	-2494921.3206	-2448390.9775	5317113.7257	L1 PHS CEN @ 2009.3318
XYZ	-0.0000	-0.0000	0.0000	+ XYZ ADJUSTMENTS
XYZ	-2494921.3206	-2448390.9775	5317113.7257	NEW L1 PHS CEN @ 2009.3318
XYZ	-2494921.2855	-2448390.9458	5317113.6595	NEW ARP @ 2009.3318
XYZ	-2494921.2855	-2448390.9458	5317113.6595	NEW MON @ 2009.3318
LLH	56 51 16.17151	224 27 38.53076	66.8349	NEW L1 PHS CEN @ 2009.3318
LLH	56 51 16.17162	224 27 38.53087	66.7536	NEW ARP @ 2009.3318
LLH	56 51 16.17162	224 27 38.53087	66.7536	NEW MON @ 2009.3318

STATION NAME: lev6 a 2 (Level Island 6; Level Island, Alaska USA)  
 MONUMENT: NO DOMES NUMBER

XYZ	-2412812.0457	-2579074.2577	5293282.2476	MON @ 1997.0000 (M)
XYZ	-0.0190	0.0003	-0.0044	VEL (M/YR)
NEU	0.0000	0.0000	0.0000	MON TO ARP (M)
NEU	-0.0034	-0.0019	0.0813	ARP TO L1 PHASE CENTER (M)
NEU	-0.0037	-0.0015	0.0689	ARP TO L2 PHASE CENTER (M)
XYZ	-0.2343	0.0037	-0.0543	VEL TIMES 12.3318 YRS
XYZ	0.0000	0.0000	0.0000	MON TO ARP
XYZ	-0.0340	-0.0336	0.0659	ARP TO L1 PHASE CENTER
XYZ	-2412812.3140	-2579074.2876	5293282.2592	L1 PHS CEN @ 2009.3318
XYZ	-0.0000	0.0000	0.0000	+ XYZ ADJUSTMENTS
XYZ	-2412812.3140	-2579074.2876	5293282.2592	NEW L1 PHS CEN @ 2009.3318
XYZ	-2412812.2800	-2579074.2540	5293282.1933	NEW ARP @ 2009.3318
XYZ	-2412812.2800	-2579074.2540	5293282.1933	NEW MON @ 2009.3318
LLH	56 27 56.37384	226 54 27.40784	25.4801	NEW L1 PHS CEN @ 2009.3318
LLH	56 27 56.37395	226 54 27.40796	25.3988	NEW ARP @ 2009.3318
LLH	56 27 56.37395	226 54 27.40796	25.3988	NEW MON @ 2009.3318

STATION NAME: ais5 a 2 (Annette Island 5; Annette Island, Alaska USA)  
 MONUMENT: NO DOMES NUMBER

XYZ	-2430153.8469	-2737192.9494	5205816.7670	MON @ 1997.0000 (M)
XYZ	-0.0147	-0.0013	-0.0087	VEL (M/YR)
NEU	0.0000	0.0000	0.0000	MON TO ARP (M)
NEU	-0.0034	-0.0019	0.0813	ARP TO L1 PHASE CENTER (M)
NEU	-0.0037	-0.0015	0.0689	ARP TO L2 PHASE CENTER (M)
XYZ	-0.1813	-0.0160	-0.1073	VEL TIMES 12.3318 YRS
XYZ	0.0000	0.0000	0.0000	MON TO ARP
XYZ	-0.0342	-0.0356	0.0647	ARP TO L1 PHASE CENTER
XYZ	-2430154.0624	-2737193.0011	5205816.7244	L1 PHS CEN @ 2009.3318
XYZ	0.0000	0.0000	0.0000	+ XYZ ADJUSTMENTS
XYZ	-2430154.0624	-2737193.0011	5205816.7244	NEW L1 PHS CEN @ 2009.3318
XYZ	-2430154.0282	-2737192.9654	5205816.6597	NEW ARP @ 2009.3318
XYZ	-2430154.0282	-2737192.9654	5205816.6597	NEW MON @ 2009.3318
LLH	55 4 8.65794	228 24 1.66886	32.4119	NEW L1 PHS CEN @ 2009.3318
LLH	55 4 8.65805	228 24 1.66897	32.3306	NEW ARP @ 2009.3318
LLH	55 4 8.65805	228 24 1.66897	32.3306	NEW MON @ 2009.3318



REMOTE STATION INFORMATION

STATION NAME: 1054 1  
 MONUMENT: NO DOMES NUMBER  
 XYZ -2415360.1829 -2718045.5883 5222560.7616 MON @ 2009.3317 (M)  
 NEU -0.0016 -0.0007 1.5000 MON TO ARP (M)  
 NEU 0.0016 0.0007 0.0850 ARP TO L1 PHASE CENTER (M)  
 NEU 0.0008 0.0012 0.0701 ARP TO L2 PHASE CENTER (M)  
 XYZ -0.5681 -0.6383 1.2328 MON TO ARP  
 XYZ -0.0307 -0.0356 0.0708 ARP TO L1 PHASE CENTER  
 XYZ -2415360.7818 -2718046.2622 5222562.0652 L1 PHS CEN @ 2009.3318

BASELINE NAME: bis5 1054  
 XYZ 0.4618 0.5681 -1.2792 + XYZ ADJUSTMENTS  
 XYZ -2415360.3200 -2718045.6941 5222560.7861 NEW L1 PHS CEN @ 2009.3318  
 XYZ -2415360.2893 -2718045.6585 5222560.7152 NEW ARP @ 2009.3318  
 XYZ -2415359.7211 -2718045.0202 5222559.4824 NEW MON @ 2009.3318  
 LLH 55 19 58.67263 228 22 28.10122 5.3319 NEW L1 PHS CEN @ 2009.3318  
 LLH 55 19 58.67258 228 22 28.10118 5.2469 NEW ARP @ 2009.3318  
 LLH 55 19 58.67263 228 22 28.10122 3.7469 NEW MON @ 2009.3318

BASELINE NAME: lev6 1054  
 XYZ 0.4650 0.5483 -1.2431 + XYZ ADJUSTMENTS  
 XYZ -2415360.3167 -2718045.7139 5222560.8221 NEW L1 PHS CEN @ 2009.3318  
 XYZ -2415360.2860 -2718045.6783 5222560.7513 NEW ARP @ 2009.3318  
 XYZ -2415359.7179 -2718045.0400 5222559.5185 NEW MON @ 2009.3318  
 LLH 55 19 58.67296 228 22 28.10211 5.3687 NEW L1 PHS CEN @ 2009.3318  
 LLH 55 19 58.67290 228 22 28.10207 5.2837 NEW ARP @ 2009.3318  
 LLH 55 19 58.67296 228 22 28.10211 3.7837 NEW MON @ 2009.3318

BASELINE NAME: ais5 1054  
 XYZ 0.4596 0.5153 -1.2692 + XYZ ADJUSTMENTS  
 XYZ -2415360.3222 -2718045.7469 5222560.7960 NEW L1 PHS CEN @ 2009.3318  
 XYZ -2415360.2915 -2718045.7113 5222560.7252 NEW ARP @ 2009.3318  
 XYZ -2415359.7233 -2718045.0730 5222559.4924 NEW MON @ 2009.3318  
 LLH 55 19 58.67172 228 22 28.10312 5.3634 NEW L1 PHS CEN @ 2009.3318  
 LLH 55 19 58.67167 228 22 28.10308 5.2784 NEW ARP @ 2009.3318  
 LLH 55 19 58.67172 228 22 28.10312 3.7784 NEW MON @ 2009.3318

G-FILES

Axx2009 5 2 9 5 2  
 B2009 5 2 130 9 5 2 327 1 page5 v0810.20IGS 226 1 2 27NGS 2009 5 6IFDDFX  
 Iant\_info.003 NGS 20090501  
 C00090001 -795615644 35 2696540744 64 945541770 54 X1229A1054X1229ABIS5  
 D 1 2 5925660 1 3 -7873734 2 3 -3932368

Axx2009 5 2 9 5 2  
 B2009 5 2 130 9 5 2 327 1 page5 v0810.20IGS 226 1 2 27NGS 2009 5 6IFDDFX  
 Iant\_info.003 NGS 20090501  
 C00090002 25474379 48 1389707860 105 707226749 74 X1229A1054X1229ALEV6  
 D 1 2 8548113 1 3 -6918825 2 3 -5342543

Axx2009 5 2 9 5 2  
 B2009 5 2 130 9 5 2 327 1 page5 v0810.20IGS 226 1 2 27NGS 2009 5 6IFDDFX  
 Iant\_info.003 NGS 20090501  
 C00090003 -147943048 35 -191478924 46 -167428327 63 X1229A1054X1229AAIS5  
 D 1 2 8769931 1 3 -7728950 2 3 -8819178

POST-FIT RMS BY SATELLITE VS. BASELINE

	OVERALL	03	06	07	08	10	13	15	16
bis5-1054	0.012	0.012	...	...	0.007	0.012	0.011	0.013	...
	19	23	24	25	28				
bis5-1054	0.014	0.013	...	0.010	0.011				
	OVERALL	03	06	07	08	10	13	15	16
lev6-1054	0.012	0.014	...	...	0.007	0.011	0.012	0.017	...
	19	23	24	25	28				
lev6-1054	0.016	0.011	...	0.010	0.010				
	OVERALL	03	06	07	08	10	13	15	16
ais5-1054	0.012	0.013	...	...	0.008	0.012	0.013	0.015	...
	19	23	25	28					
ais5-1054	0.015	0.013	0.010	0.012					

OBS BY SATELLITE VS. BASELINE

	OVERALL	03	06	07	08	10	13	15	16
bis5-1054	1534	165	...	...	233	224	190	62	...
	19	23	24	25	28				
bis5-1054	204	50	...	233	173				
	OVERALL	03	06	07	08	10	13	15	16
lev6-1054	1486	165	...	...	233	215	193	62	...
	19	23	24	25	28				
lev6-1054	202	50	...	233	133				
	OVERALL	03	06	07	08	10	13	15	16
ais5-1054	1551	164	...	...	233	217	202	62	...
	19	23	25	28					
ais5-1054	221	51	233	168					

Covariance Matrix for the xyz OPUS Position (meters<sup>2</sup>).

0.0000105644	0.0000015661	-0.0000012555
0.0000015661	0.0000383044	-0.0000017924
-0.0000012555	-0.0000017924	0.0000274689

Covariance Matrix for the enu OPUS Position (meters<sup>2</sup>).

0.0000212492	-0.0000110088	0.0000079720
-0.0000110088	0.0000255317	-0.0000008251
0.0000079720	-0.0000008251	0.0000295569

Horizontal network accuracy = 0.01224 meters.

Vertical network accuracy = 0.01066 meters.

Derivation of NAD 83 vector components

Position of reference station ARP in NAD\_83(CORS96)(EPOCH:2003.0000).

	Xa(m)	Ya(m)	Za(m)	
BIS5	-2494920.44060	-2448392.05858	5317113.38841	2003.00
LEV6	-2412811.42529	-2579075.35282	5293281.97185	2003.00
AIS5	-2430153.20716	-2737194.06415	5205816.48535	2003.00

Position of reference station monument in NAD\_83(CORS96)(EPOCH:2003.0000).

	Xr(m)	Yr(m)	Zr(m)	
BIS5	-2494920.44060	-2448392.05858	5317113.38841	2003.00
LEV6	-2412811.42529	-2579075.35282	5293281.97185	2003.00
AIS5	-2430153.20716	-2737194.06415	5205816.48535	2003.00

Velocity of reference station monument in NAD\_83(CORS96)(EPOCH:2003.0000).

	Vx (m/yr)	Vy (m/yr)	Vz (m/yr)
BIS5	0.00490	0.00450	0.00990
LEV6	0.00220	0.00120	0.00480
AIS5	0.00620	-0.00040	0.00060

Vectors from unknown station monument to reference station monument  
in NAD\_83(CORS96)(EPOCH:2003.0000).

	Xr-X= DX(m)	Yr-Y= DY(m)	Zr-Z= DZ(m)	
BIS5	-79561.56860	269654.08942	94554.07141	2003.00
LEV6	2547.44671	138970.79518	70722.65485	2003.00
AIS5	-14794.33516	-19147.91615	-16742.83165	2003.00

This position and the above vector components were computed without any knowledge by the National Geodetic Survey regarding the equipment or field operating procedures used.

FILE: 10661210.09o 000038258

NGS OPUS SOLUTION REPORT  
=====

All computed coordinate accuracies are listed as peak-to-peak values.  
For additional information: [www.ngs.noaa.gov/OPUS/Using\\_OPUS.html#accuracy](http://www.ngs.noaa.gov/OPUS/Using_OPUS.html#accuracy)

USER: weston.renoud@noaa.gov  
RINEX FILE: 1066121x.09o

DATE: May 06, 2009  
TIME: 05:55:21 UTC

SOFTWARE: page5 0810.20 master29.pl 081023      START: 2009/05/01 23:15:00  
EPHEMERIS: igr15295.eph [rapid]                    STOP: 2009/05/02 01:23:00  
NAV FILE: brdc1210.09n                            OBS USED: 4958 / 5204 : 95%  
ANT NAME: TRM55971.00                           # FIXED AMB: 31 / 37 : 84%  
ARP HEIGHT: 1.5                                   OVERALL RMS: 0.013(m)

REF FRAME: NAD\_83(CORS96) (EPOCH:2003.0000)                    ITRF00 (EPOCH:2009.3315)

X:        -2415358.876(m)    0.004(m)                    -2415359.725(m)    0.004(m)  
Y:        -2718046.200(m)    0.072(m)                    -2718045.096(m)    0.072(m)  
Z:            5222559.312(m)    0.019(m)                    5222559.493(m)    0.019(m)

LAT:        55 19 58.66097            0.058(m)                    55 19 58.67125            0.058(m)  
E LON:       228 22 28.18151            0.045(m)                    228 22 28.10391            0.045(m)  
W LON:       131 37 31.81849            0.045(m)                    131 37 31.89609            0.045(m)  
EL HGT:                3.789(m)    0.017(m)                    3.789(m)    0.017(m)  
ORTHO HGT:            9.664(m)    0.121(m) [NAVD88 (Computed using GEOID06)]

	UTM COORDINATES	STATE PLANE COORDINATES
	UTM (Zone 09)	SPC (5001 AK 1)
Northing (Y) [meters]	6134983.210	391423.846
Easting (X) [meters]	333464.491	948202.691
Convergence [degrees]	-2.15989510	1.69678528
Point Scale	0.99994023	0.99990058
Combined Factor	0.99993963	0.00000000

US NATIONAL GRID DESIGNATOR: 9UUB3346434983(NAD 83)

BASE STATIONS USED

PID	DESIGNATION	LATITUDE	LONGITUDE	DISTANCE(m)
DK6423	BIS5 BIORKA ISLAND 5 CORS ARP	N565116.162	W1353221.387	296620.8
DJ3035	LEV6 LEVEL ISLAND 6 CORS ARP	N562756.364	W1330532.511	155952.2
DK6482	AIS5 ANNETTE ISLAND 5 CORS ARP	N550408.647	W1313558.255	29425.1

NEAREST NGS PUBLISHED CONTROL POINT

AI4914	BM NO 37	N551958.661	W1313731.819	0.0
--------	----------	-------------	--------------	-----

BASE STATION INFORMATION

STATION NAME: bis5 a 2 (Biorka Island 5; Biorka Island, Alaska USA)  
 MONUMENT: NO DOMES NUMBER

XYZ	-2494921.0833	-2448390.9914	5317113.6533	MON @ 1997.0000 (M)
XYZ	-0.0164	0.0037	0.0005	VEL (M/YR)
NEU	0.0000	0.0000	0.0000	MON TO ARP (M)
NEU	-0.0034	-0.0019	0.0813	ARP TO L1 PHASE CENTER (M)
NEU	-0.0037	-0.0015	0.0689	ARP TO L2 PHASE CENTER (M)
XYZ	-0.2022	0.0456	0.0062	VEL TIMES 12.3316 YRS
XYZ	0.0000	0.0000	0.0000	MON TO ARP
XYZ	-0.0351	-0.0318	0.0662	ARP TO L1 PHASE CENTER
XYZ	-2494921.3206	-2448390.9775	5317113.7257	L1 PHS CEN @ 2009.3315
XYZ	0.0000	-0.0000	-0.0000	+ XYZ ADJUSTMENTS
XYZ	-2494921.3206	-2448390.9776	5317113.7257	NEW L1 PHS CEN @ 2009.3315
XYZ	-2494921.2855	-2448390.9458	5317113.6595	NEW ARP @ 2009.3315
XYZ	-2494921.2855	-2448390.9458	5317113.6595	NEW MON @ 2009.3315
LLH	56 51 16.17151	224 27 38.53076	66.8349	NEW L1 PHS CEN @ 2009.3315
LLH	56 51 16.17162	224 27 38.53087	66.7536	NEW ARP @ 2009.3315
LLH	56 51 16.17162	224 27 38.53087	66.7536	NEW MON @ 2009.3315

STATION NAME: lev6 a 2 (Level Island 6; Level Island, Alaska USA)  
 MONUMENT: NO DOMES NUMBER

XYZ	-2412812.0457	-2579074.2577	5293282.2476	MON @ 1997.0000 (M)
XYZ	-0.0190	0.0003	-0.0044	VEL (M/YR)
NEU	0.0000	0.0000	0.0000	MON TO ARP (M)
NEU	-0.0034	-0.0019	0.0813	ARP TO L1 PHASE CENTER (M)
NEU	-0.0037	-0.0015	0.0689	ARP TO L2 PHASE CENTER (M)
XYZ	-0.2343	0.0037	-0.0543	VEL TIMES 12.3316 YRS
XYZ	0.0000	0.0000	0.0000	MON TO ARP
XYZ	-0.0340	-0.0336	0.0659	ARP TO L1 PHASE CENTER
XYZ	-2412812.3140	-2579074.2876	5293282.2592	L1 PHS CEN @ 2009.3315
XYZ	0.0000	-0.0000	-0.0000	+ XYZ ADJUSTMENTS
XYZ	-2412812.3140	-2579074.2876	5293282.2592	NEW L1 PHS CEN @ 2009.3315
XYZ	-2412812.2800	-2579074.2540	5293282.1933	NEW ARP @ 2009.3315
XYZ	-2412812.2800	-2579074.2540	5293282.1933	NEW MON @ 2009.3315
LLH	56 27 56.37384	226 54 27.40784	25.4801	NEW L1 PHS CEN @ 2009.3315
LLH	56 27 56.37395	226 54 27.40796	25.3988	NEW ARP @ 2009.3315
LLH	56 27 56.37395	226 54 27.40796	25.3988	NEW MON @ 2009.3315

STATION NAME: ais5 a 2 (Annette Island 5; Annette Island, Alaska USA)  
 MONUMENT: NO DOMES NUMBER

XYZ	-2430153.8469	-2737192.9494	5205816.7670	MON @ 1997.0000 (M)
XYZ	-0.0147	-0.0013	-0.0087	VEL (M/YR)
NEU	0.0000	0.0000	0.0000	MON TO ARP (M)
NEU	-0.0034	-0.0019	0.0813	ARP TO L1 PHASE CENTER (M)
NEU	-0.0037	-0.0015	0.0689	ARP TO L2 PHASE CENTER (M)
XYZ	-0.1813	-0.0160	-0.1073	VEL TIMES 12.3316 YRS
XYZ	0.0000	0.0000	0.0000	MON TO ARP
XYZ	-0.0342	-0.0356	0.0647	ARP TO L1 PHASE CENTER
XYZ	-2430154.0624	-2737193.0011	5205816.7244	L1 PHS CEN @ 2009.3315
XYZ	0.0000	-0.0000	0.0000	+ XYZ ADJUSTMENTS
XYZ	-2430154.0624	-2737193.0011	5205816.7244	NEW L1 PHS CEN @ 2009.3315
XYZ	-2430154.0282	-2737192.9654	5205816.6597	NEW ARP @ 2009.3315
XYZ	-2430154.0282	-2737192.9654	5205816.6597	NEW MON @ 2009.3315
LLH	55 4 8.65794	228 24 1.66886	32.4119	NEW L1 PHS CEN @ 2009.3315
LLH	55 4 8.65805	228 24 1.66897	32.3306	NEW ARP @ 2009.3315
LLH	55 4 8.65805	228 24 1.66897	32.3306	NEW MON @ 2009.3315

REMOTE STATION INFORMATION

STATION NAME: 1066 1  
 MONUMENT: NO DOMES NUMBER  
 XYZ -2415360.3732 -2718045.6145 5222560.7825 MON @ 2009.3314 (M)  
 NEU -0.0016 -0.0007 1.5000 MON TO ARP (M)  
 NEU 0.0016 0.0007 0.0850 ARP TO L1 PHASE CENTER (M)  
 NEU 0.0008 0.0012 0.0701 ARP TO L2 PHASE CENTER (M)  
 XYZ -0.5681 -0.6383 1.2328 MON TO ARP  
 XYZ -0.0307 -0.0356 0.0708 ARP TO L1 PHASE CENTER  
 XYZ -2415360.9721 -2718046.2884 5222562.0861 L1 PHS CEN @ 2009.3315

BASELINE NAME: bis5 1066  
 XYZ 0.6505 0.5484 -1.2812 + XYZ ADJUSTMENTS  
 XYZ -2415360.3216 -2718045.7400 5222560.8049 NEW L1 PHS CEN @ 2009.3315  
 XYZ -2415360.2908 -2718045.7043 5222560.7341 NEW ARP @ 2009.3315  
 XYZ -2415359.7227 -2718045.0661 5222559.5013 NEW MON @ 2009.3315  
 LLH 55 19 58.67204 228 22 28.10288 5.3675 NEW L1 PHS CEN @ 2009.3315  
 LLH 55 19 58.67198 228 22 28.10284 5.2825 NEW ARP @ 2009.3315  
 LLH 55 19 58.67204 228 22 28.10288 3.7825 NEW MON @ 2009.3315

BASELINE NAME: lev6 1066  
 XYZ 0.6466 0.4762 -1.3003 + XYZ ADJUSTMENTS  
 XYZ -2415360.3255 -2718045.8122 5222560.7858 NEW L1 PHS CEN @ 2009.3315  
 XYZ -2415360.2948 -2718045.7766 5222560.7150 NEW ARP @ 2009.3315  
 XYZ -2415359.7266 -2718045.1383 5222559.4822 NEW MON @ 2009.3315  
 LLH 55 19 58.67018 228 22 28.10544 5.3840 NEW L1 PHS CEN @ 2009.3315  
 LLH 55 19 58.67013 228 22 28.10540 5.2990 NEW ARP @ 2009.3315  
 LLH 55 19 58.67018 228 22 28.10544 3.7990 NEW MON @ 2009.3315

BASELINE NAME: ais5 1066  
 XYZ 0.6477 0.5316 -1.2860 + XYZ ADJUSTMENTS  
 XYZ -2415360.3244 -2718045.7568 5222560.8001 NEW L1 PHS CEN @ 2009.3315  
 XYZ -2415360.2937 -2718045.7212 5222560.7293 NEW ARP @ 2009.3315  
 XYZ -2415359.7255 -2718045.0829 5222559.4965 NEW MON @ 2009.3315  
 LLH 55 19 58.67156 228 22 28.10340 5.3718 NEW L1 PHS CEN @ 2009.3315  
 LLH 55 19 58.67151 228 22 28.10336 5.2868 NEW ARP @ 2009.3315  
 LLH 55 19 58.67156 228 22 28.10340 3.7868 NEW MON @ 2009.3315

G-FILES

Axx2009 5 1 9 5 2  
 B2009 5 12315 9 5 2 123 1 page5 v0810.20IGS 226 1 2 27NGS 2009 5 6IFDDFX  
 Iant\_info.003 NGS 20090501  
 C00090001 -795615628 39 2696541203 52 945541582 57 X1219A1066X1219ABIS5  
 D 1 2 5936586 1 3 -9007484 2 3 -5245597

Axx2009 5 1 9 5 2  
 B2009 5 12315 9 5 2 123 1 page5 v0810.20IGS 226 1 2 27NGS 2009 5 6IFDDFX  
 Iant\_info.003 NGS 20090501  
 C00090002 25474467 53 1389708843 69 707227111 69 X1219A1066X1219ALEV6  
 D 1 2 7879129 1 3 -8769746 2 3 -5475035

Axx2009 5 1 9 5 2  
 B2009 5 12315 9 5 2 123 1 page5 v0810.20IGS 226 1 2 27NGS 2009 5 6IFDDFX  
 Iant\_info.003 NGS 20090501  
 C00090003 -147943027 41 -191478825 47 -167428368 50 X1219A1066X1219AAIS5  
 D 1 2 9402615 1 3 -8031189 2 3 -8318564

POST-FIT RMS BY SATELLITE VS. BASELINE

	OVERALL	02	03	04	06	07	08	10	13
bis5-1066	0.013	0.017	0.022	0.012	...	0.011	0.018	0.015	...
	16	20	23	24	25	31	32		
bis5-1066	0.013	0.011	0.010	...	0.007	...	0.026		
	OVERALL	02	03	04	06	07	08	10	13
lev6-1066	0.012	0.016	0.021	0.012	...	0.010	0.015	0.015	...
	16	20	23	24	25	31	32		
lev6-1066	0.014	0.013	0.009	...	0.007	...	0.027		
	OVERALL	02	03	04	06	07	08	10	13
ais5-1066	0.012	0.018	0.019	0.015	...	0.009	0.017	0.017	...
	16	20	23	25	31	32			
ais5-1066	0.013	0.014	0.009	0.008	...	...			

OBS BY SATELLITE VS. BASELINE

	OVERALL	02	03	04	06	07	08	10	13
bis5-1066	1700	197	54	111	...	254	105	92	...
	16	20	23	24	25	31	32		
bis5-1066	244	118	254	...	254	...	17		
	OVERALL	02	03	04	06	07	08	10	13
lev6-1066	1702	197	35	111	...	254	105	95	...
	16	20	23	24	25	31	32		
lev6-1066	245	129	251	...	254	...	26		
	OVERALL	02	03	04	06	07	08	10	13
ais5-1066	1556	70	67	98	...	254	104	77	...
	16	20	23	25	31	32			
ais5-1066	245	133	254	254	...	...			

Covariance Matrix for the xyz OPUS Position (meters<sup>2</sup>).

0.0000133578	0.0000013105	-0.0000015235
0.0000013105	0.0000214978	-0.0000013592
-0.0000015235	-0.0000013592	0.0000233556

Covariance Matrix for the enu OPUS Position (meters<sup>2</sup>).

0.0000156481	-0.0000033255	0.0000020278
-0.0000033255	0.0000186598	0.0000012414
0.0000020278	0.0000012414	0.0000239032

Horizontal network accuracy = 0.01018 meters.

Vertical network accuracy = 0.00959 meters.

Derivation of NAD 83 vector components

Position of reference station ARP in NAD\_83(CORS96)(EPOCH:2003.0000).

	Xa(m)	Ya(m)	Za(m)	
BIS5	-2494920.44060	-2448392.05858	5317113.38841	2003.00
LEV6	-2412811.42529	-2579075.35282	5293281.97185	2003.00
AIS5	-2430153.20716	-2737194.06415	5205816.48535	2003.00

Position of reference station monument in NAD\_83(CORS96)(EPOCH:2003.0000).

	Xr(m)	Yr(m)	Zr(m)	
BIS5	-2494920.44060	-2448392.05858	5317113.38841	2003.00
LEV6	-2412811.42529	-2579075.35282	5293281.97185	2003.00
AIS5	-2430153.20716	-2737194.06415	5205816.48535	2003.00

Velocity of reference station monument in NAD\_83(CORS96)(EPOCH:2003.0000).

	Vx (m/yr)	Vy (m/yr)	Vz (m/yr)
BIS5	0.00490	0.00450	0.00990
LEV6	0.00220	0.00120	0.00480
AIS5	0.00620	-0.00040	0.00060

Vectors from unknown station monument to reference station monument  
in NAD\_83(CORS96)(EPOCH:2003.0000).

	Xr-X= DX(m)	Yr-Y= DY(m)	Zr-Z= DZ(m)	
BIS5	-79561.56460	269654.14142	94554.07641	2003.00
LEV6	2547.45071	138970.84718	70722.65985	2003.00
AIS5	-14794.33116	-19147.86415	-16742.82665	2003.00

This position and the above vector components were computed without any knowledge by the National Geodetic Survey regarding the equipment or field operating procedures used.



## Divers Least Depth Gauge Report

Dive Completed: April 22, 2009 (DN112)

Location: Lake Washington, Seattle, Washington

Latitude - 47/39/01.97N Longitude - 122/16/17.32W

Divers: ENS Glen Rice, ENS Mark Andrews, SST Adam Argento & LTjg Caryn Arnold

DLDG S/N: 68337

CTD S/N: 4616

Surface Pressure (mb): 1021

Surface Gauge Reading (psia): 14.78

Lead Line (M)	1st DLDG reading (psia)	2nd DLDG reading (psia)	Average (psia)	Computed Depth (M)
1	16.04	16.23	<b>16.14</b>	<b>1.03</b>
2	17.57	17.64	<b>17.61</b>	<b>2.06</b>
3	19.02	19.08	<b>19.05</b>	<b>3.07</b>
4	20.43	20.48	<b>20.46</b>	<b>4.07</b>
5	21.86	21.90	<b>21.88</b>	<b>5.06</b>
6	23.25	-	<b>23.25</b>	<b>6.02</b>

Notes:

The dive was completed on DN112 and the cast used for this report was from DN107. (SVP file 09107175)

# PTC Electronics Incorporated

PO Box 72, Wyckoff, NJ 07481 Phone: (201) 847-0500 • Fax: (201) 847-1394 • URL: www.PTCElectronics.com

DATE 04/02/2008  
TRANSDUCER TYPE Digital Pressure Gage-D2000  
SERIAL NUMBER 68337  
PRESSURE RANGE/ACC'Y 0-100psia 0.1% fs.  
EXCITATION VOLTAGE NA  
PRESSURE STANDARD USED DRUCK DPI 600  
SPECIFIED ACCURACY 0.03%  
CALIBRATION PERIOD Bi-annual  
LAST CALIBRATED 06/01/06  
READOUT Digital

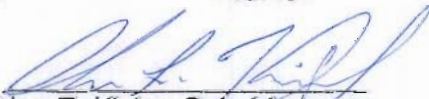
DATA TAKEN BY John C. Kicks

### CALIBRATION CONDITIONS:

BAROMETRIC PRESSURE 14.64 psia  
AMBIENT TEMPERATURE 72°F  
PRESSURE MEDIA Air

PRESSURE APPLIED	REFERENCE PRESSURE	OUTPUT (UNITS) psia	
		Increasing	Decreasing
-1.00	13.64	13.47	13.47
0.00	14.64	14.48	14.47
1.00	15.64	15.48	15.48
2.00	16.64	16.48	16.48
3.00	17.64	17.48	17.48
4.00	18.64	18.48	18.49
5.00	19.64	19.48	19.48
6.00	20.64	20.48	20.49
7.00	21.64	21.48	21.48
12.00	26.64	26.49	26.49
17.00	31.64	31.48	31.48
22.00	36.64	36.49	36.50
27.00	41.64	41.47	41.47
32.00	46.64	46.48	

APPROVED by

  
Alan F. Kicks, Q.A. Manager

**NOAA Ship FAIRWEATHER  
LASER RANGEFINDER Accuracy test**

Testing date: 04/13/2009, 04/22/2009

Testing personnel: Mark Andrews, Matthew Andring, Annie Raymond, Patricia Raymond, Glen Rice

Trial	Actual Distance	LR		Actual Height	LR	
		LR 001481 Distance	000676 Distance		LR 001481 Height	000676 Height
1	10	10.1	10.1	2.0	2.1	2.0
2	10	10.0	10.0	2.0	2.0	2.0
3	10	10.0	10.0	2.0	2.0	2.0
4	20	20.1	20.2	2.0	2.1	2.1
5	20	20.1	20.1	2.0	2.0	2.0
6	20	20.1	20.1	2.0	2.1	2.1
7	50	50.0	50.1	2.0	2.0	1.8
8	50	50.1	50.1	2.0	2.1	1.9
9	50	50.1	50.0	2.0	1.8	1.9
10	100	100.1	100.2	2.0	2.0	2.1
11	100	100.0	100.1	2.0	2.0	2.0
12	100	100.2	100.1	2.0	1.8	1.7

Trial	Actual Distance	LR i0929 Distance	LR i0929	
			Actual Height	LR i0929 Height
1	10	9.94	1.0	1.10
2	10	9.93	1.0	0.98
3	10	9.95	1.0	1.06
4	20	19.91	1.0	1.07
5	20	19.90	1.0	1.11
6	20	19.88	1.0	0.96
7	50	49.92	1.0	0.94
8	50	49.90	1.0	0.93
9	50	49.88	1.0	1.04
10	100	99.90	1.0	1.19
11	100	99.89	1.0	1.06
12	100	99.89	1.0	1.08

LR = Laser Rangefinder  
All distances are measured in meters.



## Lead Line & Sounding Pole Calibration Report

Field unit: FA

Lead Line / Sounding Pole Identification Number:  
Line 10-01-05 w/ lead 20-05

Date of Calibration: 4/20/09

Method of Calibration:                    x Steel tape                    Permanent graduation marks  
Other

Location: Seattle, WA

Chief of Party: CDR Baird

Lead Line / Sounding Pole Unit of Measure: Meters (measured from bottom of lead to bottom of mark)

Measured by: AR/LS

Recorded by: AR

Checked by: AR

**Graduated Marking  
(a)**

**Calibration Measurement  
(b)**

**Lead Line Corrector  
(c = b - a)**

1

0.992

-0.008

2

1.992

-0.008

3

2.992

-0.008

4

3.99

-0.01

5

4.987

-0.013

6

5.985

-0.015

7

6.984

-0.016

8

7.983

-0.017

9

8.982

-0.018

10

9.98

-0.02

Average Correction

-0.0133

Standard Deviation

0.004547282

## Lead Line & Sounding Pole Calibration Report

Field unit: FA

Lead Line / Sounding Pole Identification Number: 10\_5\_09

Date of Calibration: 4/27/09

Method of Calibration:                   x Steel tape                   Permanent graduation marks  
Other

Location: Seattle, WA

Chief of Party: CDR Baird

Lead Line / Sounding Pole Unit of Measure: Meters (measured from bottom of lead to bottom of mark)

Measured by: DF/BN

Recorded by: DF

Checked by: DF

**Graduated Marking  
(a)**

**Calibration Measurement  
(b)**

**Lead Line Corrector  
(c = b - a)**

1

1

0

2

1.995

-0.005

3

2.99

-0.01

4

3.885

-0.115

5

4.882

-0.118

6

5.74

-0.26

7

6.967

-0.033

8

7.962

-0.038

9

8.955

-0.045

10

9.946

-0.054

Average Correction

-0.0678

Standard Deviation

0.079147963

## Lead Line & Sounding Pole Calibration Report

Field unit: FA

Lead Line / Sounding Pole Identification Number:  
Line 10-02-05 w/ lead 10-02-04

Date of Calibration: 4/20/09

Method of Calibration:                   x Steel tape                   Permanent graduation marks  
Other

Location: Seattle, WA

Chief of Party: CDR Baird

Lead Line / Sounding Pole Unit of Measure: Meters (measured from bottom of lead to bottom of mark)

Measured by: AR/LS

Recorded by: AR

Checked by: AR

**Graduated Marking  
(a)**

**Calibration Measurement  
(b)**

**Lead Line Corrector  
(c = b - a)**

1

1

0

2

1.99

-0.01

3

2.89

-0.11

4

3.976

-0.024

5

4.97

-0.03

6

5.965

-0.035

7

6.955

-0.045

8

7.95

-0.05

9

8.945

-0.055

10

9.94

-0.06

Average Correction

-0.0419

Standard Deviation

0.030722594

## Lead Line & Sounding Pole Calibration Report

Field unit: FA

Lead Line / Sounding Pole Identification Number:  
20\_01\_05 (Lead 10\_02\_04)

Date of Calibration: 4/28/2009

Method of Calibration:                    x Steel tape                    Permanent graduation marks                    Other

Location: Seattle, WA

Chief of Party: CDR Baird

Lead Line / Sounding Pole Unit of Measure: Meters (measured from bottom of lead to bottom of mark)

Measured by: DF/BN

Recorded by: DF

Checked by:

Graduated Marking  
(a)

Calibration Measurement  
(b)

Lead Line Corrector  
(c = b - a)

1	1.021	0.021
2	2.002	0.002
3	2.993	-0.007
4	3.988	-0.012
5	4.991	-0.009
6	5.998	-0.002
7	6.994	-0.006
8	7.995	-0.005
9	8.994	-0.006
10	9.991	-0.009
11	10.993	-0.007
12	11.992	-0.008
13	12.988	-0.012
14	13.986	-0.014
15	14.984	-0.016
16	15.983	-0.017
17	16.982	-0.018
18	17.986	-0.014
19	18.981	-0.019
20	19.986	-0.014
	Average Correction	-0.0086
	Standard Deviation	0.008875751



## Lead Line & Sounding Pole Calibration Report

Field unit: FA

Lead Line / Sounding Pole Identification Number: 20\_02\_05

Date of Calibration: 04/28/2009

Method of Calibration:                    x Steel tape                    Permanent graduation marks  
Other

Location: Seattle, WA

Chief of Party: CDR Baird

Lead Line / Sounding Pole Unit of Measure: Meters (measured from bottom of lead to bottom of mark)

Measured by: DF/BN/JL

Recorded by: DF

Checked by:

Graduated Marking (a)	Calibration Measurement (b)	Lead Line Corrector (c = b - a)
1	1.004	0.004
2	1.998	-0.002
3	2.992	-0.008
4	3.988	-0.012
5	4.98	-0.02
6	5.974	-0.026
7	6.97	-0.03
8	7.967	-0.033
9	8.962	-0.038
10	9.955	-0.045
11	10.9887	-0.0113
12	11.989	-0.011
13	12.985	-0.015
14	13.985	-0.015
15	14.987	-0.013
16	15.985	-0.015
17	16.985	-0.015
18	17.987	-0.013
19	18.99	-0.01
20	19.99	-0.01
	Average Correction	-0.016915
	Standard Deviation	0.011978809

## Lead Line & Sounding Pole Calibration Report

Field unit: FA

Lead Line / Sounding Pole Identification Number: 30\_01\_03 (Lead 10\_02\_04)

Date of Calibration: 04/28/2009

Method of Calibration:                   x Steel tape                   Permanent graduation marks  
Other

Location: Seattle, WA

Chief of Party: CDR Baird

Lead Line / Sounding Pole Unit of Measure: Meters (measured from bottom of lead to bottom of mark)

Measured by: DF/BN/MA

Recorded by: DF

Checked by:

Graduated Marking (a)	Calibration Measurement (b)	Lead Line Corrector (c = b - a)
1	0.998	-0.002
2	1.975	-0.025
3	2.973	-0.027
4	3.996	-0.004
5	4.965	-0.035
6	5.961	-0.039
7	6.966	-0.034
8	7.959	-0.041
9	8.955	-0.045
10	9.952	-0.048
11	10.958	-0.042
12	11.953	-0.047
13	12.954	-0.046
14	13.949	-0.051
15	14.949	-0.051
16	15.95	-0.05
17	16.948	-0.052
18	17.951	-0.049
19	18.968	-0.032
20	19.974	-0.026
21	20.976	-0.024
22	21.953	-0.047
23	22.956	-0.044
24	23.965	-0.035
25	24.955	-0.045
26	25.953	-0.047
27	26.95	-0.05
28	27.956	-0.044
29	28.951	-0.049
30	29.957	-0.043
	Average Correction	-0.03
	Standard Deviation	0.015937377

# SEA-BIRD ELECTRONICS, INC.

1808 136th Place N.E., Bellevue, Washington, 98005 USA

Phone: (425) 643 - 9866 Fax (425) 643 - 9954 Email: seabird@seabird.com

SENSOR SERIAL NUMBER: 4585  
CALIBRATION DATE: 24-Dec-08

SBE19plus TEMPERATURE CALIBRATION DATA  
ITS-90 TEMPERATURE SCALE

## ITS-90 COEFFICIENTS

a0 = 1.152958e-003  
a1 = 2.769577e-004  
a2 = -1.238595e-006  
a3 = 1.923712e-007

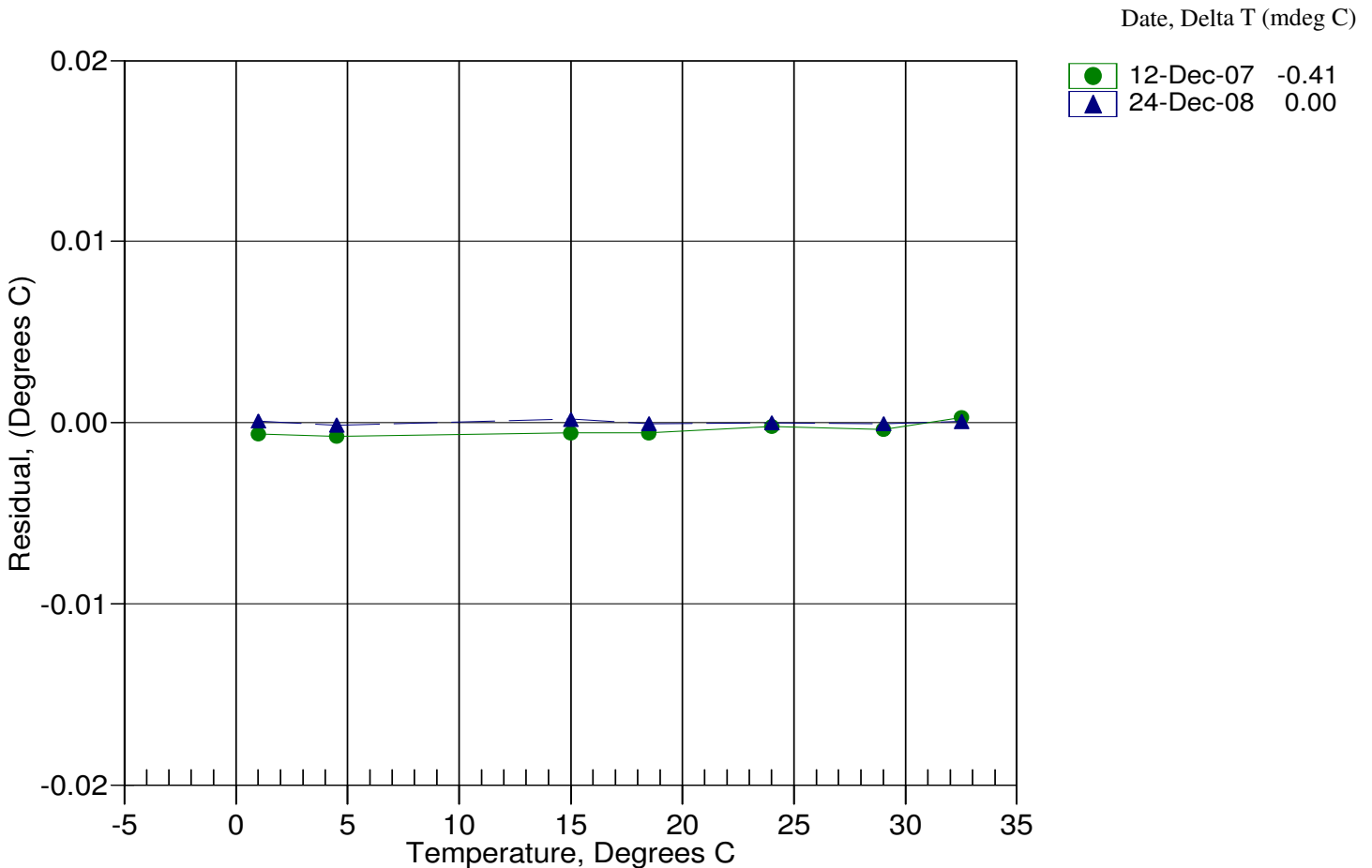
BATH TEMP (ITS-90)	INSTRUMENT OUTPUT(n)	INST TEMP (ITS-90)	RESIDUAL (ITS-90)
1.0000	686671.898	1.0001	0.0001
4.5000	613990.153	4.4999	-0.0001
15.0000	430449.356	15.0002	0.0002
18.5000	380356.864	18.4999	-0.0001
24.0000	311746.237	24.0000	-0.0000
29.0001	259029.610	29.0000	-0.0001
32.5000	226970.136	32.5001	0.0001

$$MV = (n - 524288) / 1.6e+007$$

$$R = (MV * 2.900e+009 + 1.024e+008) / (2.048e+004 - MV * 2.0e+005)$$

$$\text{Temperature ITS-90} = 1 / \{ a_0 + a_1[\ln(R)] + a_2[\ln^2(R)] + a_3[\ln^3(R)] \} - 273.15 \text{ (}^\circ\text{C)}$$

$$\text{Residual} = \text{instrument temperature} - \text{bath temperature}$$



# SEA-BIRD ELECTRONICS, INC.

1808 136th Place N.E., Bellevue, Washington, 98005 USA

Phone: (425) 643 - 9866 Fax (425) 643 - 9954 Email: seabird@seabird.com

SENSOR SERIAL NUMBER: 4585  
CALIBRATION DATE: 24-Dec-08

SBE19plus CONDUCTIVITY CALIBRATION DATA  
PSS 1978: C(35,15,0) = 4.2914 Siemens/meter

**COEFFICIENTS:**

g = -1.030096e+000                      CPcor = -9.5700e-008  
h = 1.490529e-001                      CTcor = 3.2500e-006  
i = -1.755436e-004  
j = 3.495131e-005

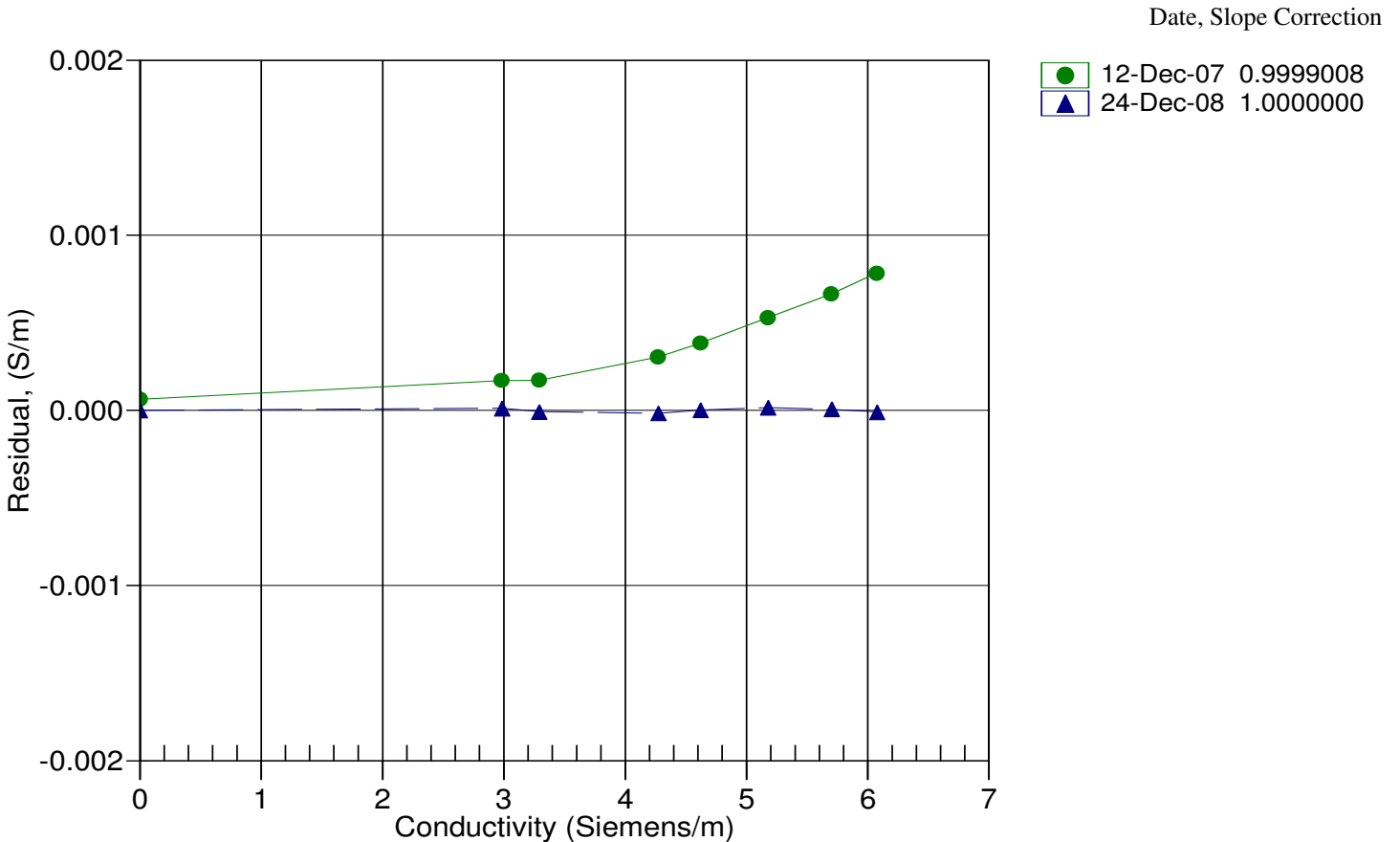
BATH TEMP (ITS-90)	BATH SAL (PSU)	BATH COND (Siemens/m)	INST FREQ (Hz)	INST COND (Siemens/m)	RESIDUAL (Siemens/m)
22.0000	0.0000	0.00000	2630.81	0.0000	0.00000
1.0000	34.9056	2.98287	5188.24	2.9829	0.00001
4.5000	34.8856	3.29062	5382.83	3.2906	-0.00001
15.0000	34.8424	4.27448	5961.81	4.2745	-0.00002
18.5000	34.8329	4.62033	6152.16	4.6203	0.00000
24.0000	34.8221	5.17939	6447.70	5.1794	0.00002
29.0001	34.8149	5.70213	6711.97	5.7021	0.00001
32.5000	34.8105	6.07509	6894.15	6.0751	-0.00001

f = INST FREQ / 1000.0

Conductivity = (g + hf<sup>2</sup> + if<sup>3</sup> + jf<sup>4</sup>) / (1 + δt + εp) Siemens/meter

t = temperature[°C]; p = pressure[decibars]; δ = CTcor; ε = CPcor;

Residual = instrument conductivity - bath conductivity



# SEA-BIRD ELECTRONICS, INC.

1808 136th Place N.E., Bellevue, Washington, 98005 USA

Phone: (425) 643 - 9866 Fax (425) 643 - 9954 Email: seabird@seabird.com

SENSOR SERIAL NUMBER: 4585  
CALIBRATION DATE: 29-Dec-08

SBE19plus PRESSURE CALIBRATION DATA  
5076 psia S/N 5433

## COEFFICIENTS:

PA0 = 5.029148e-001	PTCA0 = 5.087931e+005
PA1 = 1.546002e-002	PTCA1 = -1.387413e+000
PA2 = -6.698233e-010	PTCA2 = 1.147553e-001
PTEMPA0 = -6.561551e+001	PTCB0 = 2.398063e+001
PTEMPA1 = 5.126876e+001	PTCB1 = -2.075000e-003
PTEMPA2 = -2.271790e-001	PTCB2 = 0.000000e+000

## PRESSURE SPAN CALIBRATION

PRESSURE PSIA	INST OUTPUT	THERMISTOR OUTPUT	COMPUTED PRESSURE	ERROR %FSR
14.43	509698.5	1.6	14.38	-0.00
1026.03	575213.9	1.6	1025.77	-0.01
2037.81	641125.8	1.6	2037.49	-0.01
3049.21	707405.4	1.6	3049.00	-0.00
4061.89	774171.3	1.6	4061.98	0.00
5073.45	841224.4	1.6	5073.30	-0.00
4060.64	774087.2	1.6	4060.79	0.00
3049.89	707478.4	1.6	3050.21	0.01
2037.97	641159.4	1.6	2038.09	0.00
1026.00	575237.5	1.6	1026.17	0.00
14.44	509714.6	1.6	14.59	0.00

## THERMAL CORRECTION

TEMP ITS90	THERMISTOR OUTPUT	INST OUTPUT
32.50	1.93	509770.31
29.00	1.86	509746.37
24.00	1.76	509720.20
18.50	1.65	509705.55
15.00	1.58	509700.64
4.50	1.38	509686.80
1.00	1.31	509690.08

TEMP (ITS90)	SPAN (mV)
-5.00	23.99
35.00	23.91

$$y = \text{thermistor output}; t = PTEMPA0 + PTEMPA1 * y + PTEMPA2 * y^2$$

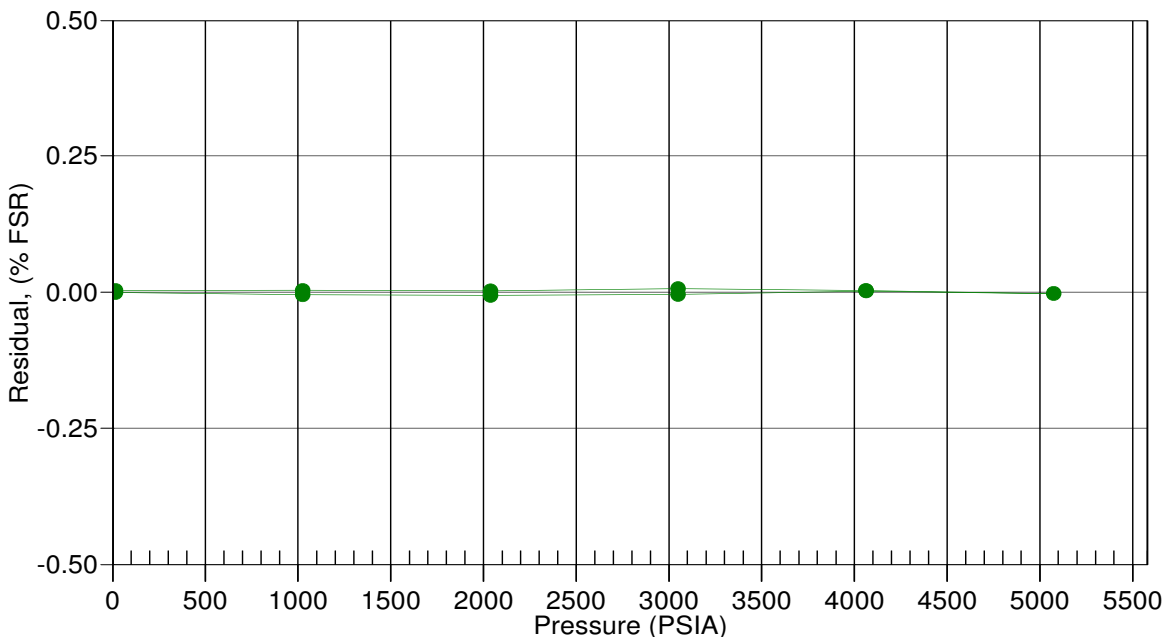
$$x = \text{pressure output} - PTCA0 - PTCA1 * t - PTCA2 * t^2$$

$$n = x * PTCB0 / (PTCB0 + PTCB1 * t + PTCB2 * t^2)$$

$$\text{pressure (psia)} = PA0 + PA1 * n + PA2 * n^2$$

Date, Avg Delta P %FS

● 29-Dec-08 0.00





# SEA-BIRD ELECTRONICS, INC.

1808 - 136th Place Northeast, Bellevue, Washington 98005 USA

Phone: (425) 643-9866 Fax: (425) 643-9954 www.seabird.com

## Conductivity Calibration Report

Customer:	Pacific Marine Center / NOAA		
Job Number:	53036	Date of Report:	12/29/2008
Model Number	SBE 19Plus	Serial Number:	19P36026-4585

*Conductivity sensors are normally calibrated 'as received', without cleaning or adjustments, allowing a determination of sensor drift. If the calibration identifies a problem or indicates cell cleaning is necessary, then a second calibration is performed after work is completed. The 'as received' calibration is not performed if the sensor is damaged or non-functional, or by customer request.*

*An 'as received' calibration certificate is provided, listing the coefficients used to convert sensor frequency to conductivity. Users must choose whether the 'as received' calibration or the previous calibration better represents the sensor condition during deployment. In SEASOFT enter the chosen coefficients using the program SEACON. The coefficient 'slope' allows small corrections for drift between calibrations (consult the SEASOFT manual). Calibration coefficients obtained after a repair or cleaning apply only to subsequent data.*

'AS RECEIVED CALIBRATION'  Performed  Not Performed

Date:  Drift since last cal:  PSU/month\*

Comments:

'CALIBRATION AFTER CLEANING & REPLATINIZING'  Performed  Not Performed

Date:  Drift since Last cal:  PSU/month\*

Comments:

*\*Measured at 3.0 S/m*

*Cell cleaning and electrode replatinizing tend to 'reset' the conductivity sensor to its original condition. Lack of drift in post-cleaning-calibration indicates geometric stability of the cell and electrical stability of the sensor circuit.*



# SEA-BIRD ELECTRONICS, INC.

1808 - 136th Place Northeast, Bellevue, Washington 98005 USA

Phone: (425) 643-9866 Fax: (425) 643-9954 www.seabird.com

## Temperature Calibration Report

Customer:	Pacific Marine Center / NOAA		
Job Number:	53036	Date of Report:	12/29/2008
Model Number	SBE 19Plus	Serial Number:	19P36026-4585

*Temperature sensors are normally calibrated 'as received', without adjustments, allowing a determination sensor drift. If the calibration identifies a problem, then a second calibration is performed after work is completed. The 'as received' calibration is not performed if the sensor is damaged or non-functional, or by customer request.*

*An 'as received' calibration certificate is provided, listing coefficients to convert sensor frequency to temperature. Users must choose whether the 'as received' calibration or the previous calibration better represents the sensor condition during deployment. In SEASOFT enter the chosen coefficients using the program SEACON. The coefficient 'offset' allows a small correction for drift between calibrations (consult the SEASOFT manual). Calibration coefficients obtained after a repair apply only to subsequent data.*

### 'AS RECEIVED CALIBRATION'

Performed  Not Performed

Date:

Drift since last cal:  Degrees Celsius/year

Comments:

### 'CALIBRATION AFTER REPAIR'

Performed  Not Performed

Date:

Drift since Last cal:  Degrees Celsius/year

Comments:

# SEA-BIRD ELECTRONICS, INC.

1808 136th Place N.E., Bellevue, Washington, 98005 USA

Phone: (425) 643 - 9866 Fax (425) 643 - 9954 Email: seabird@seabird.com

SENSOR SERIAL NUMBER: 4616  
CALIBRATION DATE: 30-Dec-08

SBE19plus TEMPERATURE CALIBRATION DATA  
ITS-90 TEMPERATURE SCALE

## ITS-90 COEFFICIENTS

a0 = 1.281404e-003  
a1 = 2.533926e-004  
a2 = 1.063479e-006  
a3 = 1.058343e-007

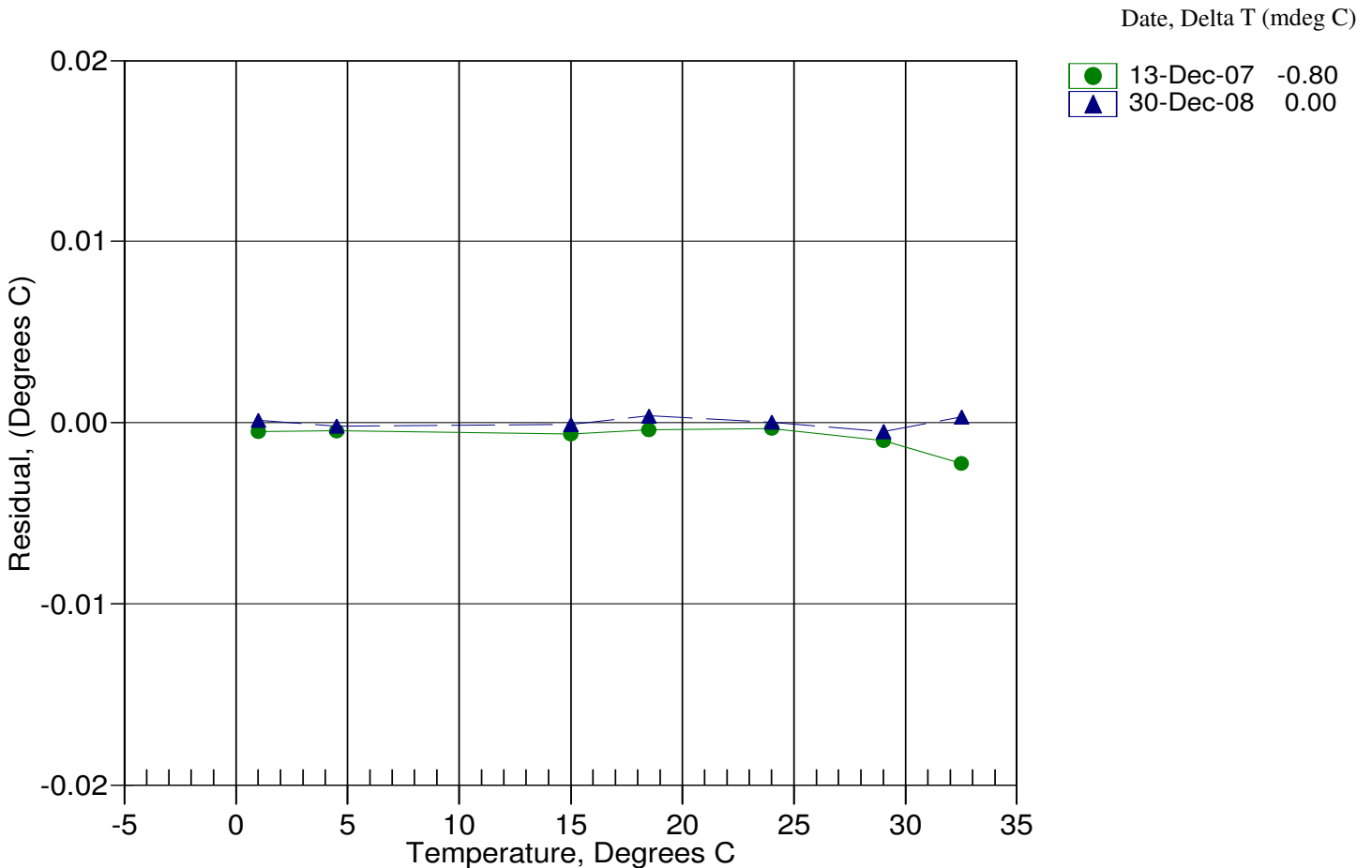
BATH TEMP (ITS-90)	INSTRUMENT OUTPUT(n)	INST TEMP (ITS-90)	RESIDUAL (ITS-90)
1.0000	622339.390	1.0001	0.0001
4.5000	552555.458	4.4998	-0.0002
15.0000	379373.339	14.9999	-0.0001
18.5000	332879.949	18.5004	0.0004
24.0000	269786.136	24.0000	0.0000
29.0000	221773.322	28.9995	-0.0005
32.5001	192769.169	32.5004	0.0003

$$MV = (n - 524288) / 1.6e+007$$

$$R = (MV * 2.900e+009 + 1.024e+008) / (2.048e+004 - MV * 2.0e+005)$$

$$\text{Temperature ITS-90} = 1 / \{ a_0 + a_1[\ln(R)] + a_2[\ln^2(R)] + a_3[\ln^3(R)] \} - 273.15 \text{ (}^\circ\text{C)}$$

$$\text{Residual} = \text{instrument temperature} - \text{bath temperature}$$





# SEA-BIRD ELECTRONICS, INC.

1808 136th Place N.E., Bellevue, Washington, 98005 USA

Phone: (425) 643 - 9866 Fax (425) 643 - 9954 Email: seabird@seabird.com

SENSOR SERIAL NUMBER: 4616  
CALIBRATION DATE: 30-Dec-08

SBE19plus CONDUCTIVITY CALIBRATION DATA  
PSS 1978: C(35,15,0) = 4.2914 Siemens/meter

## COEFFICIENTS:

g = -1.045676e+000  
h = 1.453624e-001  
i = -2.792262e-004  
j = 4.047864e-005

CPcor = -9.5700e-008  
CTcor = 3.2500e-006

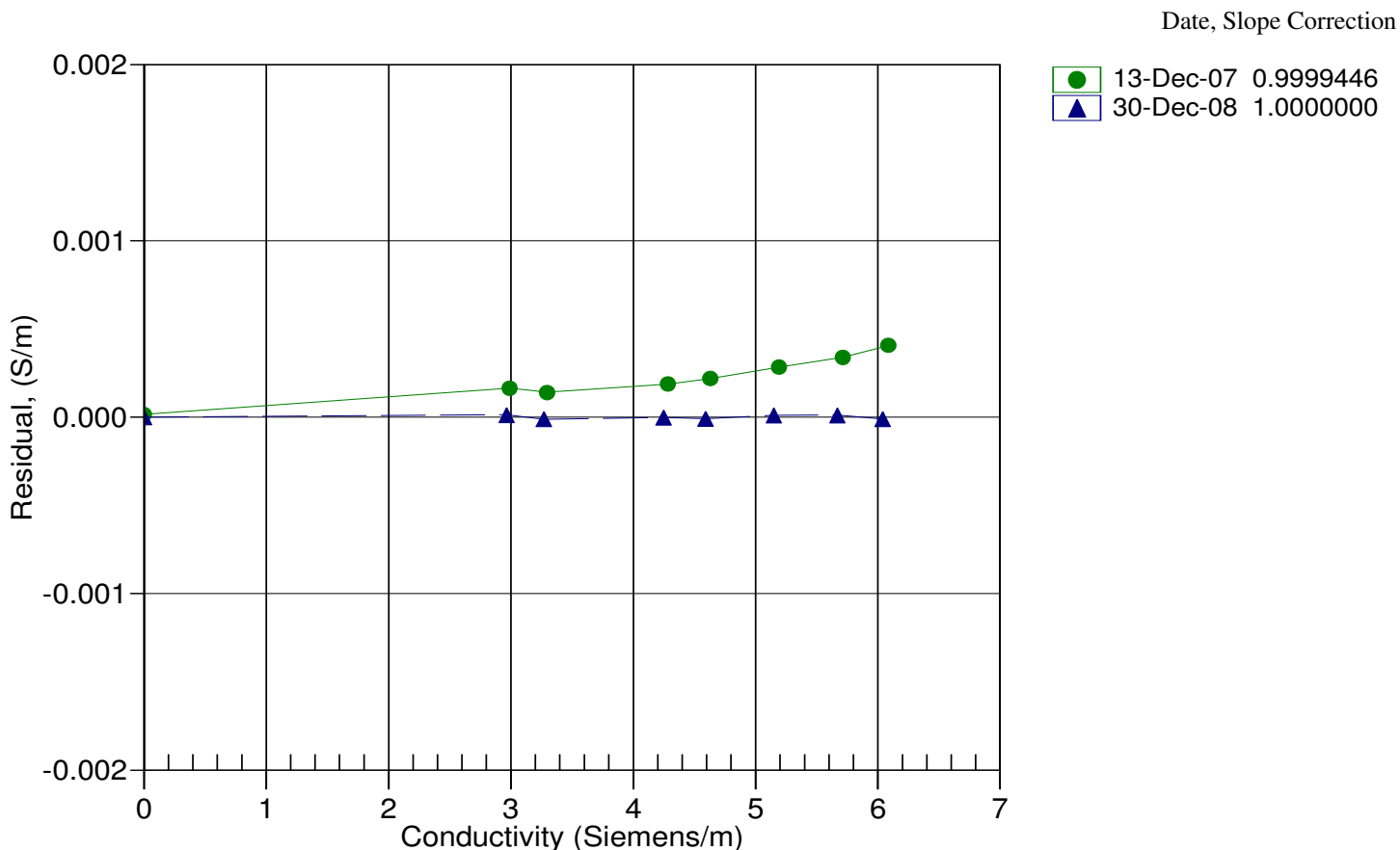
BATH TEMP (ITS-90)	BATH SAL (PSU)	BATH COND (Siemens/m)	INST FREQ (Hz)	INST COND (Siemens/m)	RESIDUAL (Siemens/m)
22.0000	0.0000	0.00000	2686.32	0.0000	0.00000
1.0000	34.6635	2.96415	5258.47	2.9642	0.00001
4.5000	34.6435	3.27002	5454.79	3.2700	-0.00001
15.0000	34.6004	4.24792	6039.09	4.2479	-0.00000
18.5000	34.5912	4.59172	6231.25	4.5917	-0.00001
24.0000	34.5806	5.14743	6529.62	5.1474	0.00001
29.0000	34.5733	5.66698	6796.43	5.6670	0.00001
32.5001	34.5689	6.03772	6980.38	6.0377	-0.00001

$$f = \text{INST FREQ} / 1000.0$$

$$\text{Conductivity} = (g + hf^2 + if^3 + jf^4) / (1 + \delta t + \epsilon p) \text{ Siemens/meter}$$

$$t = \text{temperature}[\text{°C}]; p = \text{pressure}[\text{decibars}]; \delta = \text{CTcor}; \epsilon = \text{CPcor};$$

$$\text{Residual} = \text{instrument conductivity} - \text{bath conductivity}$$



# SEA-BIRD ELECTRONICS, INC.

1808 136th Place N.E., Bellevue, Washington, 98005 USA

Phone: (425) 643 - 9866 Fax (425) 643 - 9954 Email: seabird@seabird.com

SENSOR SERIAL NUMBER: 4616  
CALIBRATION DATE: 23-Dec-08

SBE19plus PRESSURE CALIBRATION DATA  
1450 psia S/N 5512

**COEFFICIENTS:**

PA0 = 8.151393e-001	PTCA0 = 5.204151e+005
PA1 = 4.427036e-003	PTCA1 = 1.499910e+001
PA2 = -1.489407e-011	PTCA2 = -2.797969e-001
PTEMPA0 = -7.628063e+001	PTCB0 = 2.473825e+001
PTEMPA1 = 4.917975e+001	PTCB1 = 5.000000e-005
PTEMPA2 = -2.452670e-001	PTCB2 = 0.000000e+000

**PRESSURE SPAN CALIBRATION**

PRESSURE PSIA	INST OUTPUT	THERMISTOR OUTPUT	COMPUTED PRESSURE	ERROR %FSR
14.56	523716.6	2.0	14.62	0.00
300.91	588379.6	2.0	300.80	-0.01
587.28	653125.0	2.0	587.23	-0.00
873.71	717921.0	2.0	873.75	0.00
1160.12	782709.1	2.0	1160.11	-0.00
1446.59	847531.7	2.0	1446.51	-0.01
1160.83	782900.4	2.0	1160.96	0.01
587.26	653145.1	2.0	587.32	0.00
300.86	588375.3	2.0	300.78	-0.01
14.56	523715.6	2.0	14.61	0.00

**THERMAL CORRECTION**

TEMP ITS90	THERMISTOR OUTPUT	INST OUTPUT
32.50	2.24	523831.27
29.00	2.16	523832.41
24.00	2.06	523825.60
18.50	1.95	523815.10
15.00	1.87	523797.80
4.50	1.66	523711.29
1.00	1.58	523637.33

TEMP (ITS90)	SPAN (mV)
-5.00	24.74
35.00	24.74

$$y = \text{thermistor output}; t = PTEMPA0 + PTEMPA1 * y + PTEMPA2 * y^2$$

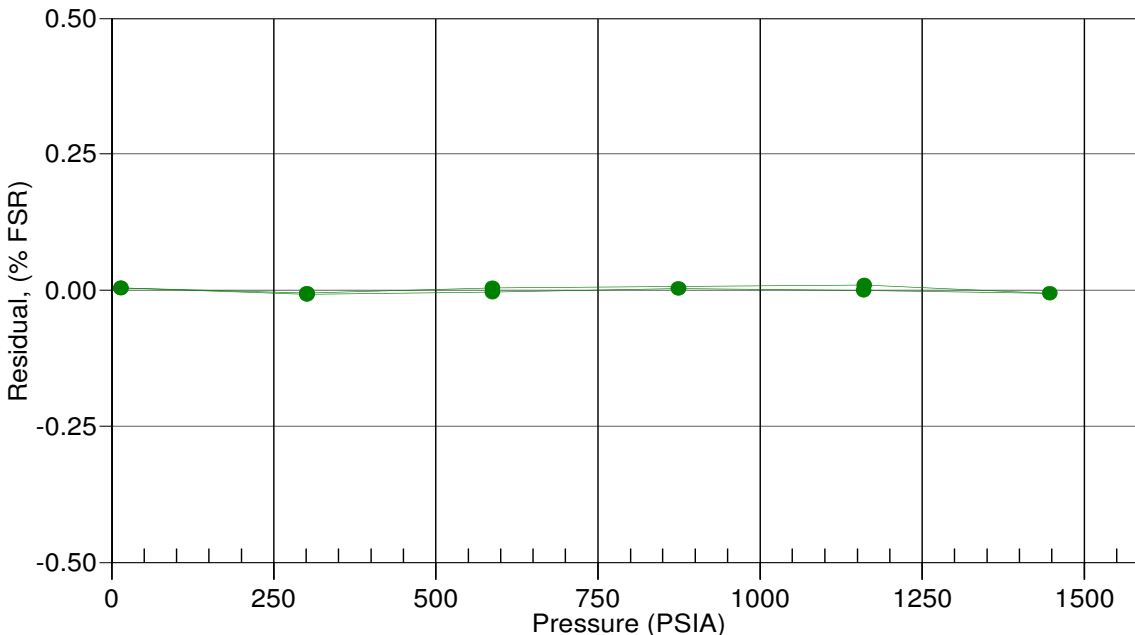
$$x = \text{pressure output} - PTCA0 - PTCA1 * t - PTCA2 * t^2$$

$$n = x * PTCB0 / (PTCB0 + PTCB1 * t + PTCB2 * t^2)$$

$$\text{pressure (psia)} = PA0 + PA1 * n + PA2 * n^2$$

Date, Avg Delta P %FS

23-Dec-08 -0.00





# SEA-BIRD ELECTRONICS, INC.

1808 - 136th Place Northeast, Bellevue, Washington 98005 USA

Phone: (425) 643-9866 Fax: (425) 643-9954 www.seabird.com

## Temperature Calibration Report

<b>Customer:</b>	Pacific Marine Center / NOAA		
<b>Job Number:</b>	53036	<b>Date of Report:</b>	12/30/2008
<b>Model Number</b>	SBE 19Plus	<b>Serial Number:</b>	19P36026-4616

*Temperature sensors are normally calibrated 'as received', without adjustments, allowing a determination sensor drift. If the calibration identifies a problem, then a second calibration is performed after work is completed. The 'as received' calibration is not performed if the sensor is damaged or non-functional, or by customer request.*

*An 'as received' calibration certificate is provided, listing coefficients to convert sensor frequency to temperature. Users must choose whether the 'as received' calibration or the previous calibration better represents the sensor condition during deployment. In SEASOFT enter the chosen coefficients using the program SEACON. The coefficient 'offset' allows a small correction for drift between calibrations (consult the SEASOFT manual). Calibration coefficients obtained after a repair apply only to subsequent data.*

### 'AS RECEIVED CALIBRATION'

Performed     Not Performed

Date:

Drift since last cal:  Degrees Celsius/year

Comments:

### 'CALIBRATION AFTER REPAIR'

Performed     Not Performed

Date:

Drift since Last cal:  Degrees Celsius/year

Comments:



# SEA-BIRD ELECTRONICS, INC.

1808 - 136th Place Northeast, Bellevue, Washington 98005 USA

Phone: (425) 643-9866 Fax: (425) 643-9954 www.seabird.com

## Conductivity Calibration Report

Customer:	Pacific Marine Center / NOAA		
Job Number:	53036	Date of Report:	12/30/2008
Model Number	SBE 19Plus	Serial Number:	19P36026-4616

*Conductivity sensors are normally calibrated 'as received', without cleaning or adjustments, allowing a determination of sensor drift. If the calibration identifies a problem or indicates cell cleaning is necessary, then a second calibration is performed after work is completed. The 'as received' calibration is not performed if the sensor is damaged or non-functional, or by customer request.*

*An 'as received' calibration certificate is provided, listing the coefficients used to convert sensor frequency to conductivity. Users must choose whether the 'as received' calibration or the previous calibration better represents the sensor condition during deployment. In SEASOFT enter the chosen coefficients using the program SEACON. The coefficient 'slope' allows small corrections for drift between calibrations (consult the SEASOFT manual). Calibration coefficients obtained after a repair or cleaning apply only to subsequent data.*

'AS RECEIVED CALIBRATION'  Performed  Not Performed

Date:  Drift since last cal:  PSU/month\*

Comments:

'CALIBRATION AFTER CLEANING & REPLATINIZING'  Performed  Not Performed

Date:  Drift since Last cal:  PSU/month\*

Comments:

*\*Measured at 3.0 S/m*

*Cell cleaning and electrode replatinizing tend to 'reset' the conductivity sensor to its original condition. Lack of drift in post-cleaning-calibration indicates geometric stability of the cell and electrical stability of the sensor circuit.*

# SEA-BIRD ELECTRONICS, INC.

1808 136th Place N.E., Bellevue, Washington, 98005 USA

Phone: (425) 643 - 9866 Fax (425) 643 - 9954 Email: seabird@seabird.com

SENSOR SERIAL NUMBER: 4617  
CALIBRATION DATE: 20-Dec-08

SBE19plus TEMPERATURE CALIBRATION DATA  
ITS-90 TEMPERATURE SCALE

## ITS-90 COEFFICIENTS

a0 = 1.246846e-003  
a1 = 2.697109e-004  
a2 = -7.052860e-007  
a3 = 1.823959e-007

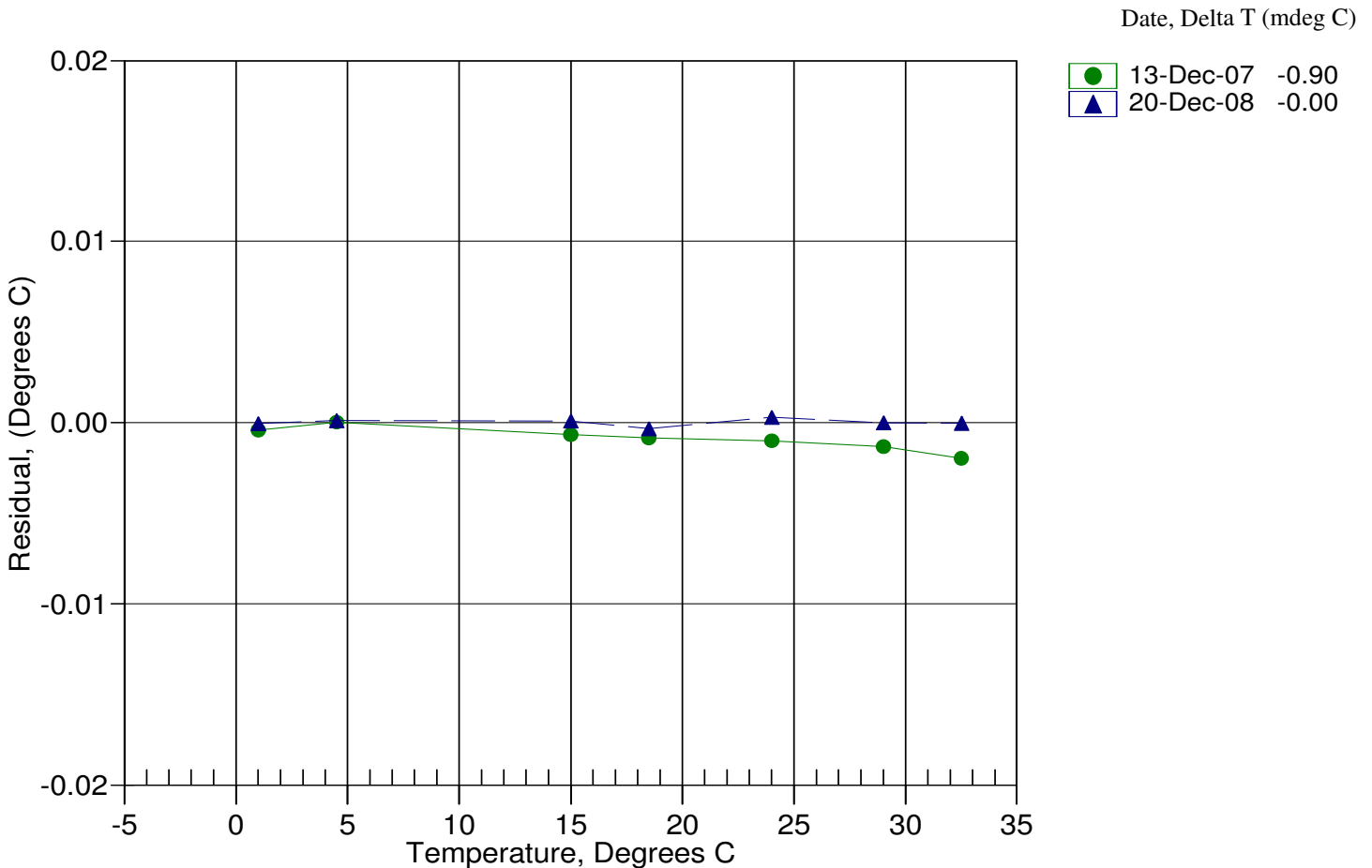
BATH TEMP (ITS-90)	INSTRUMENT OUTPUT(n)	INST TEMP (ITS-90)	RESIDUAL (ITS-90)
1.0000	585630.424	0.9999	-0.0001
4.5000	518793.136	4.5001	0.0001
15.0000	354138.373	15.0001	0.0001
18.5000	310211.898	18.4997	-0.0003
24.0000	250739.695	24.0003	0.0003
29.0000	205606.492	29.0000	-0.0000
32.5000	178394.119	32.5000	-0.0000

$$MV = (n - 524288) / 1.6e+007$$

$$R = (MV * 2.900e+009 + 1.024e+008) / (2.048e+004 - MV * 2.0e+005)$$

$$\text{Temperature ITS-90} = 1 / \{ a_0 + a_1[\ln(R)] + a_2[\ln^2(R)] + a_3[\ln^3(R)] \} - 273.15 \text{ (}^\circ\text{C)}$$

$$\text{Residual} = \text{instrument temperature} - \text{bath temperature}$$



# SEA-BIRD ELECTRONICS, INC.

1808 136th Place N.E., Bellevue, Washington, 98005 USA

Phone: (425) 643 - 9866 Fax (425) 643 - 9954 Email: seabird@seabird.com

SENSOR SERIAL NUMBER: 4617  
CALIBRATION DATE: 20-Dec-08

SBE19plus CONDUCTIVITY CALIBRATION DATA  
PSS 1978: C(35,15,0) = 4.2914 Siemens/meter

**COEFFICIENTS:**

g = -1.000141e+000                      CPcor = -9.5700e-008  
h = 1.279500e-001                      CTcor = 3.2500e-006  
i = -2.981125e-004  
j = 3.615456e-005

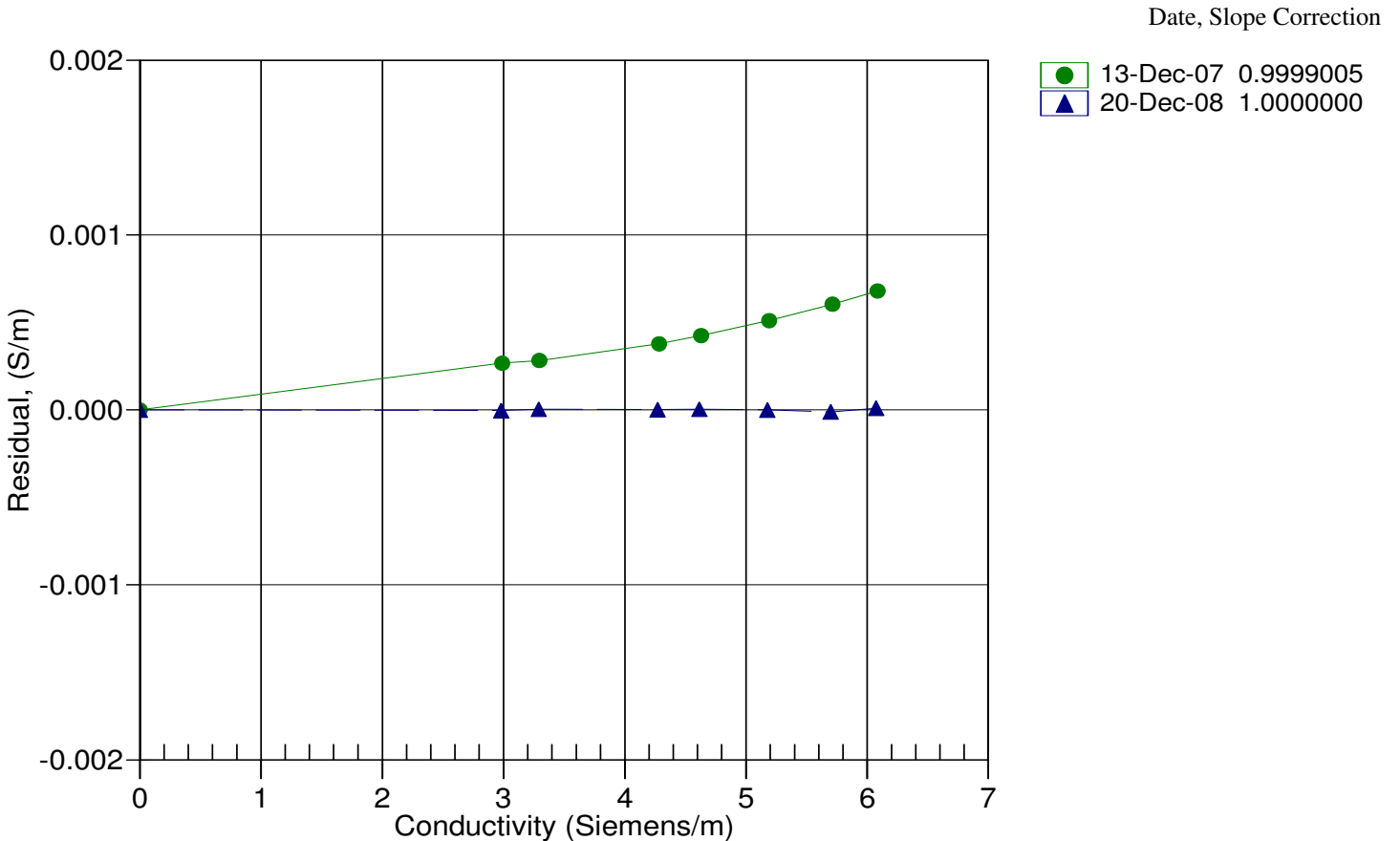
BATH TEMP (ITS-90)	BATH SAL (PSU)	BATH COND (Siemens/m)	INST FREQ (Hz)	INST COND (Siemens/m)	RESIDUAL (Siemens/m)
22.0000	0.0000	0.00000	2801.87	0.0000	0.00000
1.0000	34.8741	2.98043	5589.41	2.9804	-0.00000
4.5000	34.8541	3.28794	5800.77	3.2879	0.00000
15.0000	34.8109	4.27102	6429.24	4.2710	0.00000
18.5000	34.8011	4.61657	6635.72	4.6166	0.00000
24.0000	34.7896	5.17509	6956.19	5.1751	-0.00000
29.0000	34.7810	5.69719	7242.59	5.6972	-0.00001
32.5000	34.7748	6.06957	7439.93	6.0696	0.00001

f = INST FREQ / 1000.0

Conductivity = (g + hf<sup>2</sup> + if<sup>3</sup> + jf<sup>4</sup>) / (1 + δt + εp) Siemens/meter

t = temperature[°C]; p = pressure[decibars]; δ = CTcor; ε = CPcor;

Residual = instrument conductivity - bath conductivity



# SEA-BIRD ELECTRONICS, INC.

1808 136th Place N.E., Bellevue, Washington, 98005 USA

Phone: (425) 643 - 9866 Fax (425) 643 - 9954 Email: seabird@seabird.com

SENSOR SERIAL NUMBER: 4617  
CALIBRATION DATE: 23-Dec-08

SBE19plus PRESSURE CALIBRATION DATA  
1450 psia S/N 5513

**COEFFICIENTS:**

PA0 = -6.055955e-001	PTCA0 = 5.192474e+005
PA1 = 4.445261e-003	PTCA1 = -1.257329e+001
PA2 = -1.492962e-011	PTCA2 = 2.871586e-001
PTEMPA0 = -7.890859e+001	PTCB0 = 2.460838e+001
PTEMPA1 = 4.909915e+001	PTCB1 = 6.750000e-004
PTEMPA2 = -3.861224e-001	PTCB2 = 0.000000e+000

**PRESSURE SPAN CALIBRATION**

PRESSURE PSIA	INST OUTPUT	THERMISTOR OUTPUT	COMPUTED PRESSURE	ERROR %FSR
14.56	522528.9	2.0	14.57	0.00
300.91	586983.0	2.0	300.87	-0.00
587.28	651477.4	2.0	587.23	-0.00
873.71	716034.6	2.0	873.74	0.00
1160.12	780599.0	2.0	1160.16	0.00
1446.59	845193.3	2.0	1446.58	-0.00
1160.83	780743.0	2.0	1160.80	-0.00
587.26	651494.2	2.0	587.30	0.00
300.86	586980.7	2.0	300.86	0.00
14.56	522528.9	2.0	14.57	0.00

**THERMAL CORRECTION**

TEMP ITS90	THERMISTOR OUTPUT	INST OUTPUT
32.50	2.31	522669.88
29.00	2.24	522666.19
24.00	2.13	522662.57
18.50	2.02	522651.21
15.00	1.94	522650.29
4.50	1.72	522724.31
1.00	1.65	522781.82

TEMP (ITS90)	SPAN (mV)
-5.00	24.61
35.00	24.63

$$y = \text{thermistor output}; t = PTEMPA0 + PTEMPA1 * y + PTEMPA2 * y^2$$

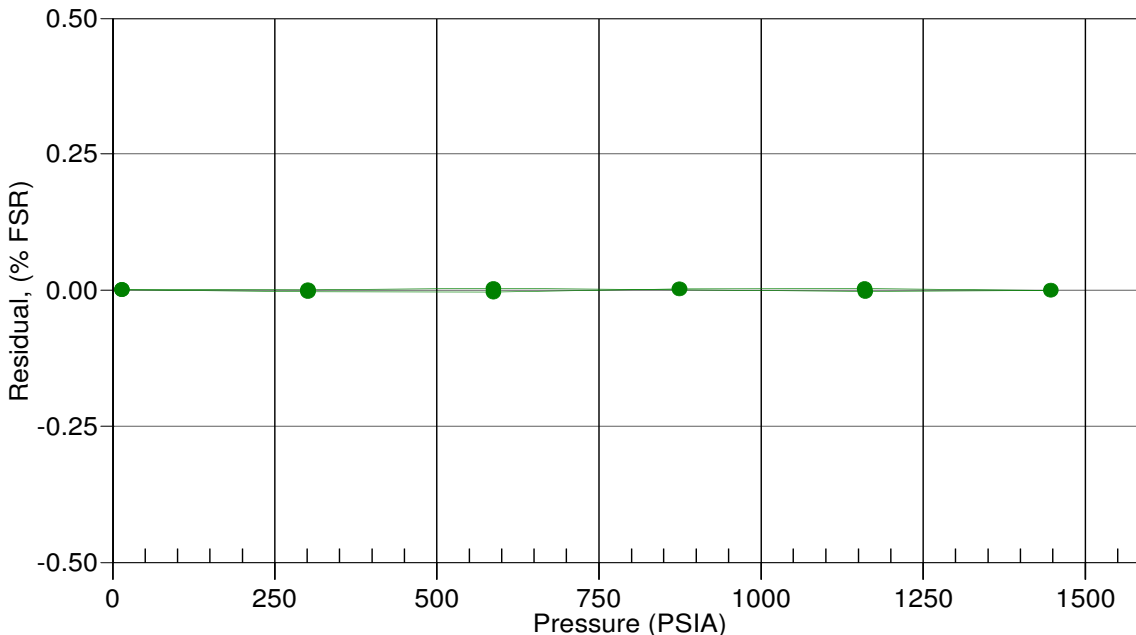
$$x = \text{pressure output} - PTCA0 - PTCA1 * t - PTCA2 * t^2$$

$$n = x * PTCB0 / (PTCB0 + PTCB1 * t + PTCB2 * t^2)$$

$$\text{pressure (psia)} = PA0 + PA1 * n + PA2 * n^2$$

Date, Avg Delta P %FS

● 23-Dec-08 -0.00





# SEA-BIRD ELECTRONICS, INC.

1808 - 136th Place Northeast, Bellevue, Washington 98005 USA

Phone: (425) 643-9866 Fax: (425) 643-9954 www.seabird.com

## Temperature Calibration Report

Customer:	Pacific Marine Center / NOAA		
Job Number:	53036	Date of Report:	12/22/2008
Model Number	SBE 19Plus	Serial Number:	19P36026-4617

*Temperature sensors are normally calibrated 'as received', without adjustments, allowing a determination sensor drift. If the calibration identifies a problem, then a second calibration is performed after work is completed. The 'as received' calibration is not performed if the sensor is damaged or non-functional, or by customer request.*

*An 'as received' calibration certificate is provided, listing coefficients to convert sensor frequency to temperature. Users must choose whether the 'as received' calibration or the previous calibration better represents the sensor condition during deployment. In SEASOFT enter the chosen coefficients using the program SEACON. The coefficient 'offset' allows a small correction for drift between calibrations (consult the SEASOFT manual). Calibration coefficients obtained after a repair apply only to subsequent data.*

### 'AS RECEIVED CALIBRATION'

Performed  Not Performed

Date:

Drift since last cal:  Degrees Celsius/year

Comments:

### 'CALIBRATION AFTER REPAIR'

Performed  Not Performed

Date:

Drift since Last cal:  Degrees Celsius/year

Comments:





# SEA-BIRD ELECTRONICS, INC.

1808 - 136th Place Northeast, Bellevue, Washington 98005 USA

Phone: (425) 643-9866 Fax: (425) 643-9954 www.seabird.com

## Conductivity Calibration Report

Customer:	Pacific Marine Center / NOAA		
Job Number:	53036	Date of Report:	12/22/2008
Model Number	SBE 19Plus	Serial Number:	19P36026-4617

*Conductivity sensors are normally calibrated 'as received', without cleaning or adjustments, allowing a determination of sensor drift. If the calibration identifies a problem or indicates cell cleaning is necessary, then a second calibration is performed after work is completed. The 'as received' calibration is not performed if the sensor is damaged or non-functional, or by customer request.*

*An 'as received' calibration certificate is provided, listing the coefficients used to convert sensor frequency to conductivity. Users must choose whether the 'as received' calibration or the previous calibration better represents the sensor condition during deployment. In SEASOFT enter the chosen coefficients using the program SEACON. The coefficient 'slope' allows small corrections for drift between calibrations (consult the SEASOFT manual). Calibration coefficients obtained after a repair or cleaning apply only to subsequent data.*

'AS RECEIVED CALIBRATION'  Performed  Not Performed

Date:  Drift since last cal:  PSU/month\*

Comments:

'CALIBRATION AFTER CLEANING & REPLATINIZING'  Performed  Not Performed

Date:  Drift since Last cal:  PSU/month\*

Comments:

*\*Measured at 3.0 S/m*

*Cell cleaning and electrode replatinizing tend to 'reset' the conductivity sensor to its original condition. Lack of drift in post-cleaning-calibration indicates geometric stability of the cell and electrical stability of the sensor circuit.*

# SEA-BIRD ELECTRONICS, INC.

1808 136th Place N.E., Bellevue, Washington, 98005 USA

Phone: (425) 643 - 9866 Fax (425) 643 - 9954 Email: seabird@seabird.com

SENSOR SERIAL NUMBER: 6121  
CALIBRATION DATE: 28-Aug-08

SBE19plus TEMPERATURE CALIBRATION DATA  
ITS-90 TEMPERATURE SCALE

## ITS-90 COEFFICIENTS

a0 = 1.289081e-003

a1 = 2.567873e-004

a2 = 1.103918e-007

a3 = 1.347008e-007

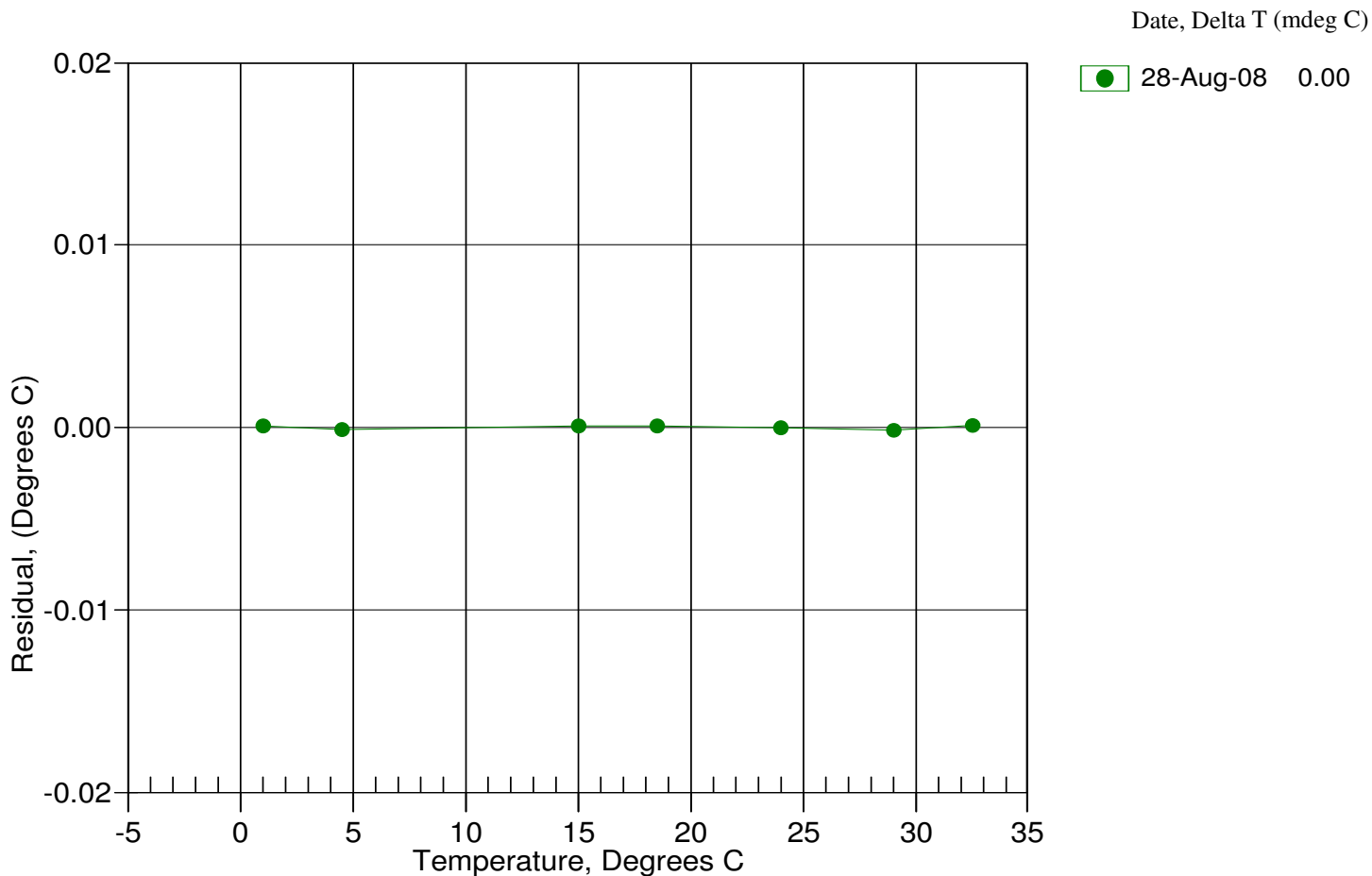
BATH TEMP (ITS-90)	INSTRUMENT OUTPUT(n)	INST TEMP (ITS-90)	RESIDUAL (ITS-90)
1.0000	648503.186	1.0001	0.0001
4.5000	575581.220	4.4999	-0.0001
15.0000	394150.390	15.0001	0.0001
18.5000	345412.610	18.5001	0.0001
24.0000	279302.814	24.0000	-0.0000
29.0001	229064.831	28.9999	-0.0002
32.5000	198774.661	32.5001	0.0001

$MV = (n - 524288) / 1.6e+007$

$R = (MV * 2.900e+009 + 1.024e+008) / (2.048e+004 - MV * 2.0e+005)$

Temperature ITS-90 =  $1 / \{a_0 + a_1[\ln(R)] + a_2[\ln^2(R)] + a_3[\ln^3(R)]\} - 273.15$  (°C)

Residual = instrument temperature - bath temperature



# SEA-BIRD ELECTRONICS, INC.

1808 136th Place N.E., Bellevue, Washington, 98005 USA

Phone: (425) 643 - 9866 Fax (425) 643 - 9954 Email: seabird@seabird.com

SENSOR SERIAL NUMBER: 6121  
CALIBRATION DATE: 28-Aug-08

SBE19plus CONDUCTIVITY CALIBRATION DATA  
PSS 1978: C(35,15,0) = 4.2914 Siemens/meter

## COEFFICIENTS:

g = -1.002097e+000  
h = 1.438184e-001  
i = -5.214257e-004  
j = 5.901932e-005

CPcor = -9.5700e-008  
CTcor = 3.2500e-006

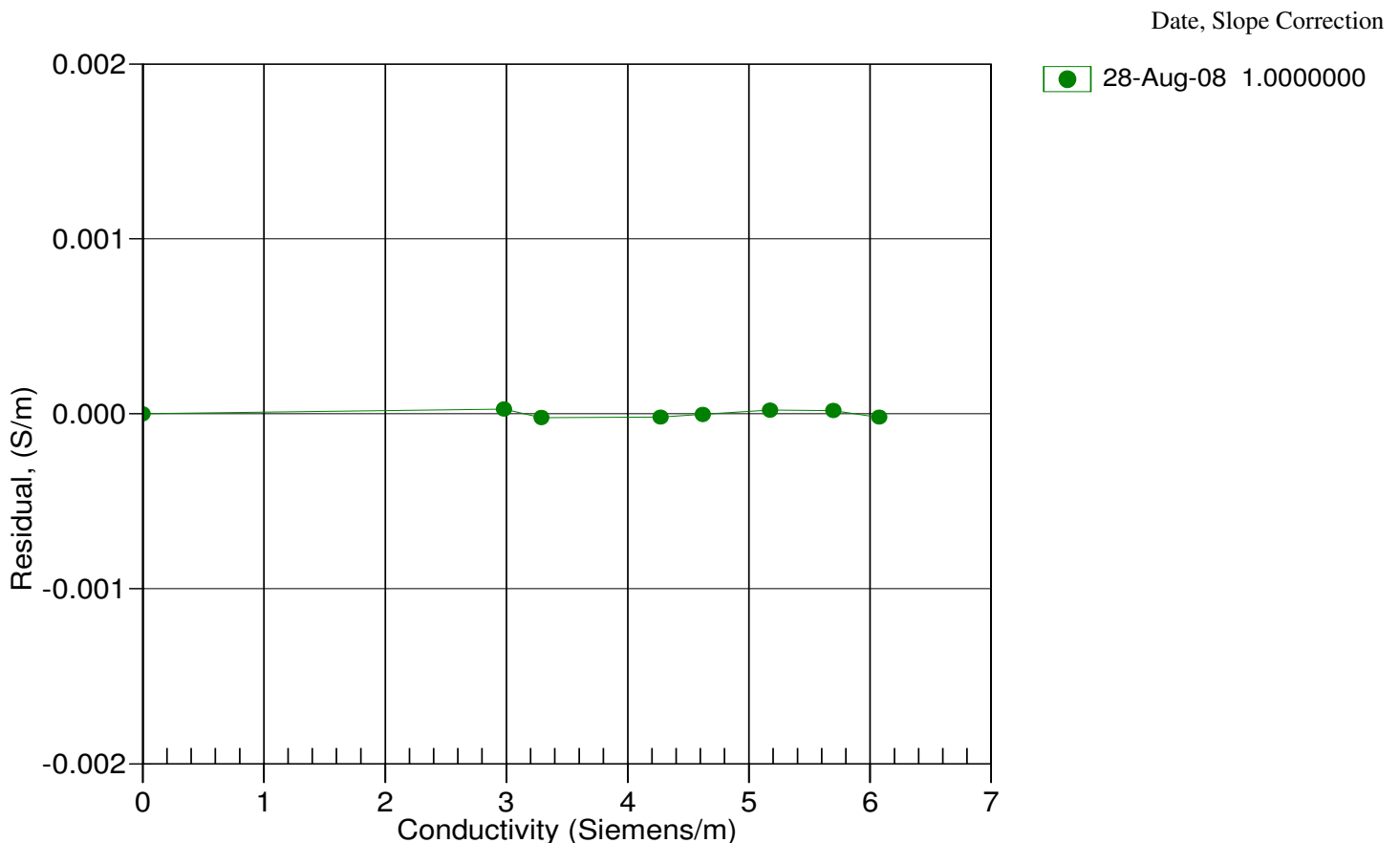
BATH TEMP (ITS-90)	BATH SAL (PSU)	BATH COND (Siemens/m)	INST FREQ (Hz)	INST COND (Siemens/m)	RESIDUAL (Siemens/m)
22.0000	0.0000	0.00000	2648.58	0.0000	0.00000
1.0000	34.8850	2.98128	5283.22	2.9813	0.00003
4.5000	34.8648	3.28885	5482.95	3.2888	-0.00002
15.0000	34.8213	4.27216	6076.87	4.2721	-0.00002
18.5000	34.8119	4.61785	6272.01	4.6178	-0.00000
24.0000	34.8011	5.17661	6574.84	5.1766	0.00002
29.0001	34.7946	5.69917	6845.52	5.6992	0.00002
32.5000	34.7904	6.07198	7032.01	6.0720	-0.00002

f = INST FREQ / 1000.0

Conductivity =  $(g + hf^2 + if^3 + jf^4) / (1 + \delta t + \epsilon p)$  Siemens/meter

t = temperature[°C]; p = pressure[decibars];  $\delta$  = CTcor;  $\epsilon$  = CPcor;

Residual = instrument conductivity - bath conductivity



# SEA-BIRD ELECTRONICS, INC.

1808 136th Place N.E., Bellevue, Washington, 98005 USA

Phone: (425) 643 - 9866 Fax (425) 643 - 9954 Email: seabird@seabird.com

SENSOR SERIAL NUMBER: 6121  
CALIBRATION DATE: 26-Aug-08

SBE19plus PRESSURE CALIBRATION DATA  
870 psia S/N 2752079

## COEFFICIENTS:

PA0 = -6.478769e-001	PTCA0 = 5.247839e+005
PA1 = 2.639452e-003	PTCA1 = -1.748425e+001
PA2 = 1.757831e-011	PTCA2 = 2.632259e-001
PTEMPA0 = -6.128910e+001	PTCB0 = 2.511463e+001
PTEMPA1 = 5.471751e+001	PTCB1 = -1.075000e-003
PTEMPA2 = -5.689142e-001	PTCB2 = 0.000000e+000

## PRESSURE SPAN CALIBRATION

PRESSURE PSIA	INST OUTPUT	THERMISTOR OUTPUT	COMPUTED PRESSURE	ERROR %FSR
14.68	530344.0	1.5	14.69	0.00
179.95	592865.0	1.5	179.94	-0.00
359.94	660894.0	1.5	359.90	-0.00
539.94	728875.0	1.5	539.90	-0.00
719.93	796800.0	1.5	719.91	-0.00
874.90	855228.0	1.5	874.89	-0.00
719.95	796828.0	1.5	719.99	0.00
539.97	728912.0	1.5	540.00	0.00
359.97	660927.0	1.5	359.99	0.00
179.96	592874.0	1.5	179.97	0.00
14.69	530337.0	1.5	14.68	-0.00

## THERMAL CORRECTION

TEMP ITS90	THERMISTOR OUTPUT	INST OUTPUT
32.50	1.75	530426.41
29.00	1.68	530439.09
24.00	1.59	530454.71
18.50	1.48	530483.73
15.00	1.42	530518.13
4.50	1.22	530644.39
1.00	1.15	530705.47

TEMP (ITS90)	SPAN (mV)
-5.00	25.12
35.00	25.08

$y = \text{thermistor output}; t = PTEMPA0 + PTEMPA1 * y + PTEMPA2 * y^2$

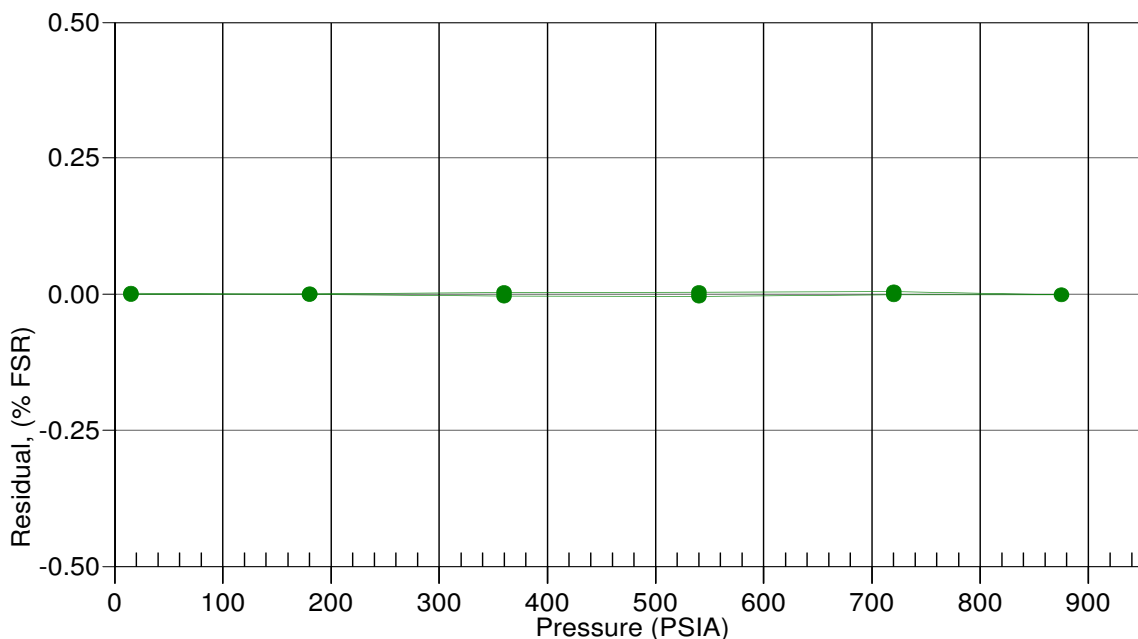
$x = \text{pressure output} - PTCA0 - PTCA1 * t - PTCA2 * t^2$

$n = x * PTCB0 / (PTCB0 + PTCB1 * t + PTCB2 * t^2)$

$\text{pressure (psia)} = PA0 + PA1 * n + PA2 * n^2$

Date, Avg Delta P %FS

26-Aug-08 0.00



# SEA-BIRD ELECTRONICS, INC.

1808 136th Place N.E., Bellevue, Washington, 98005 USA

Phone: (425) 643 - 9866 Fax (425) 643 - 9954 Email: seabird@seabird.com

SENSOR SERIAL NUMBER: 6122  
CALIBRATION DATE: 28-Aug-08

SBE19plus TEMPERATURE CALIBRATION DATA  
ITS-90 TEMPERATURE SCALE

## ITS-90 COEFFICIENTS

a0 = 1.310924e-003

a1 = 2.514962e-004

a2 = 7.231185e-007

a3 = 1.086082e-007

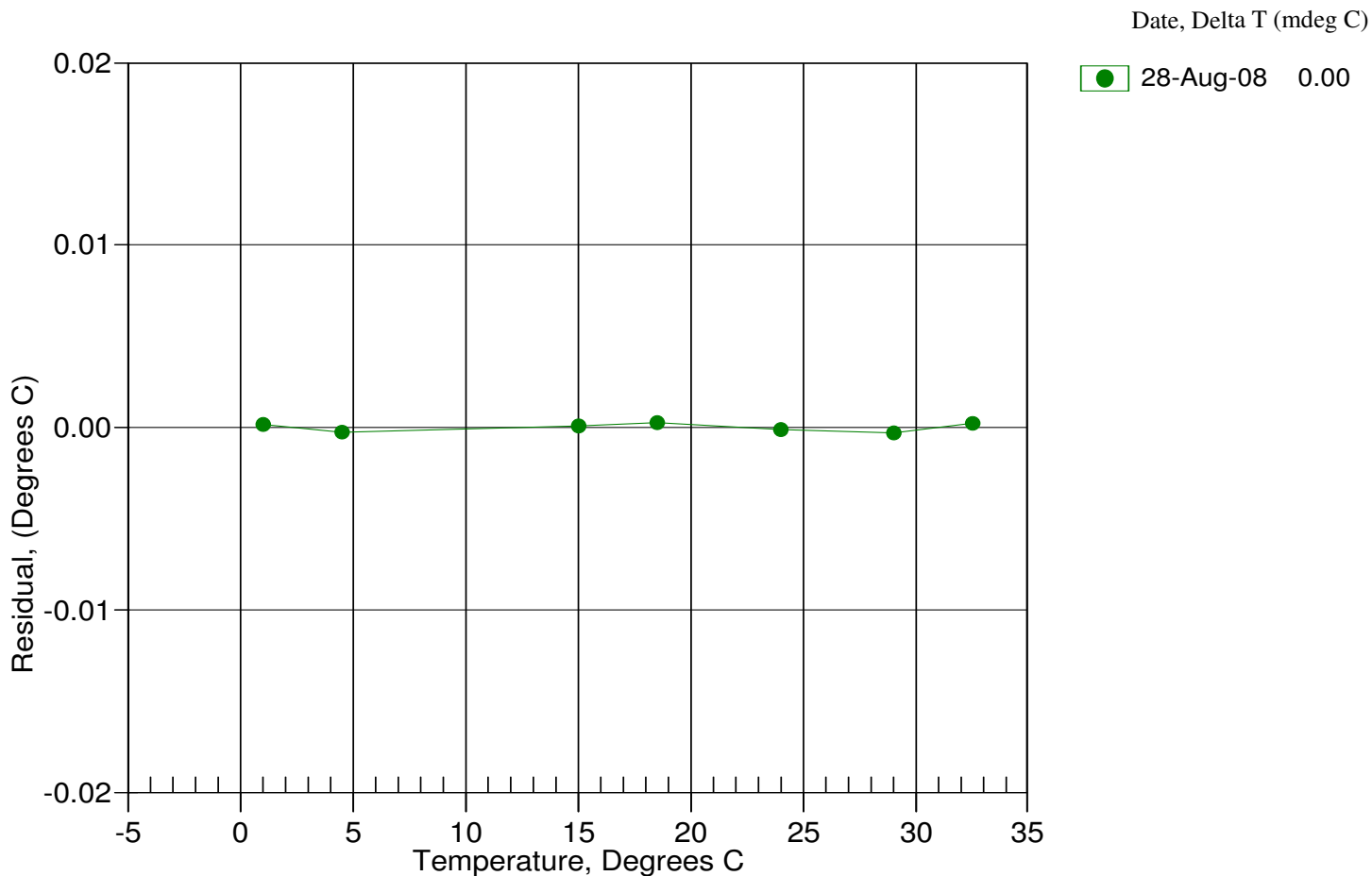
BATH TEMP (ITS-90)	INSTRUMENT OUTPUT(n)	INST TEMP (ITS-90)	RESIDUAL (ITS-90)
1.0000	640421.220	1.0002	0.0002
4.5000	567849.949	4.4997	-0.0003
15.0000	387722.085	15.0001	0.0001
18.5000	339446.305	18.5003	0.0003
24.0000	274051.763	23.9999	-0.0001
29.0001	224421.051	28.9998	-0.0003
32.5000	194523.508	32.5002	0.0002

$MV = (n - 524288) / 1.6e+007$

$R = (MV * 2.900e+009 + 1.024e+008) / (2.048e+004 - MV * 2.0e+005)$

Temperature ITS-90 =  $1 / \{a_0 + a_1[\ln(R)] + a_2[\ln^2(R)] + a_3[\ln^3(R)]\} - 273.15$  (°C)

Residual = instrument temperature - bath temperature



# SEA-BIRD ELECTRONICS, INC.

1808 136th Place N.E., Bellevue, Washington, 98005 USA

Phone: (425) 643 - 9866 Fax (425) 643 - 9954 Email: seabird@seabird.com

SENSOR SERIAL NUMBER: 6122  
CALIBRATION DATE: 28-Aug-08

SBE19plus CONDUCTIVITY CALIBRATION DATA  
PSS 1978: C(35,15,0) = 4.2914 Siemens/meter

## COEFFICIENTS:

g = -9.949806e-001                      CPcor = -9.5700e-008  
h = 1.571158e-001                      CTcor = 3.2500e-006  
i = -4.874166e-004  
j = 6.173091e-005

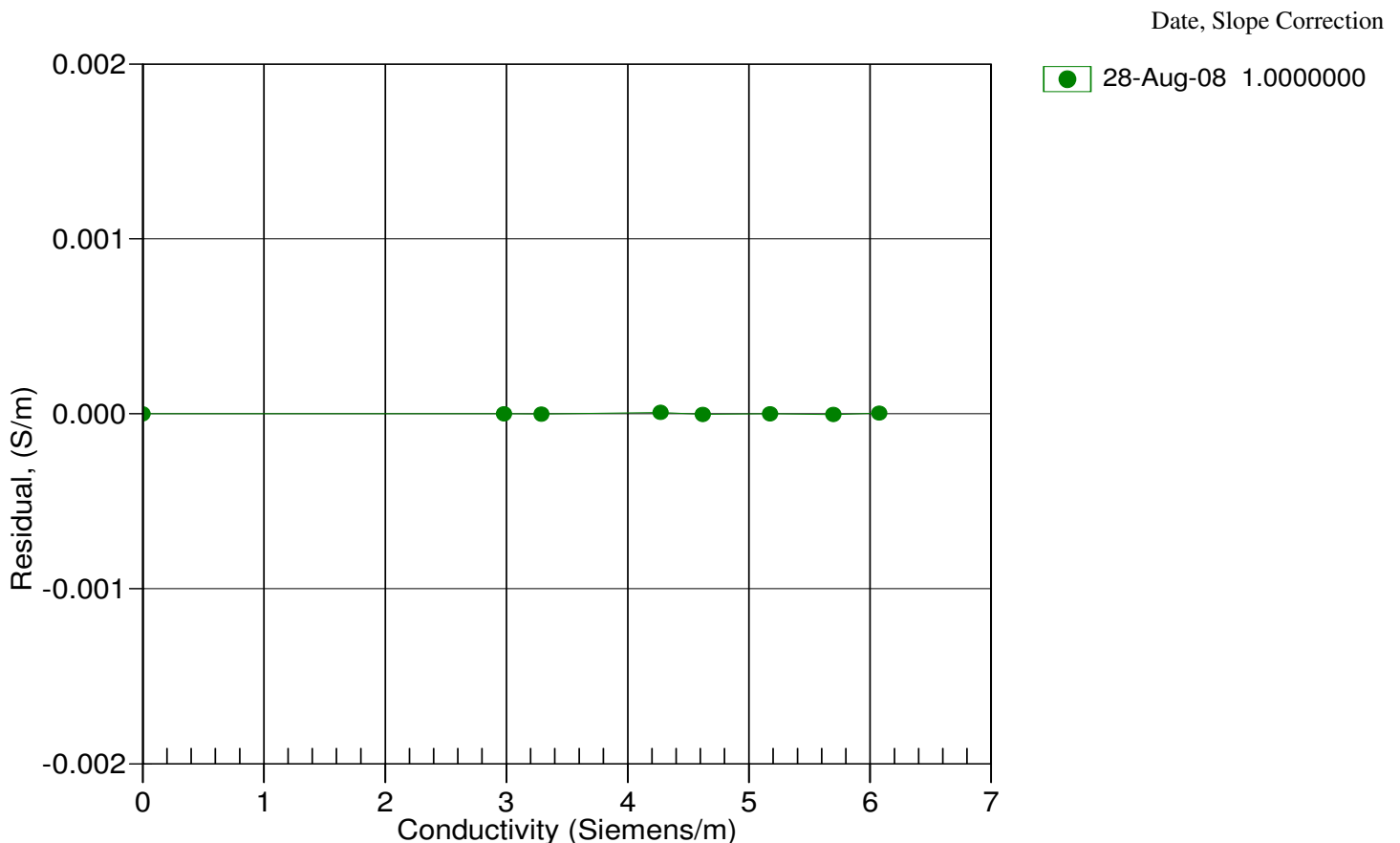
BATH TEMP (ITS-90)	BATH SAL (PSU)	BATH COND (Siemens/m)	INST FREQ (Hz)	INST COND (Siemens/m)	RESIDUAL (Siemens/m)
22.0000	0.0000	0.00000	2523.23	0.0000	0.00000
1.0000	34.8850	2.98128	5044.97	2.9813	-0.00000
4.5000	34.8648	3.28885	5236.00	3.2888	-0.00000
15.0000	34.8213	4.27216	5803.96	4.2722	0.00001
18.5000	34.8119	4.61785	5990.56	4.6178	-0.00000
24.0000	34.8011	5.17661	6280.15	5.1766	0.00000
29.0001	34.7946	5.69917	6539.03	5.6992	-0.00000
32.5000	34.7904	6.07198	6717.42	6.0720	0.00000

f = INST FREQ / 1000.0

Conductivity =  $(g + hf^2 + if^3 + jf^4) / (1 + \delta t + \epsilon p)$  Siemens/meter

t = temperature[°C]; p = pressure[decibars];  $\delta$  = CTcor;  $\epsilon$  = CPcor;

Residual = instrument conductivity - bath conductivity



# SEA-BIRD ELECTRONICS, INC.

1808 136th Place N.E., Bellevue, Washington, 98005 USA

Phone: (425) 643 - 9866 Fax (425) 643 - 9954 Email: seabird@seabird.com

SENSOR SERIAL NUMBER: 6122  
CALIBRATION DATE: 26-Aug-08

SBE19plus PRESSURE CALIBRATION DATA  
870 psia S/N 2752080

## COEFFICIENTS:

PA0 =	-1.047938e-001	PTCA0 =	5.243776e+005
PA1 =	2.635617e-003	PTCA1 =	1.680541e-001
PA2 =	2.031440e-011	PTCA2 =	-1.070257e-001
PTEMPA0 =	-6.085315e+001	PTCB0 =	2.507825e+001
PTEMPA1 =	5.350080e+001	PTCB1 =	-5.500000e-004
PTEMPA2 =	-1.784269e-001	PTCB2 =	0.000000e+000

## PRESSURE SPAN CALIBRATION

PRESSURE PSIA	INST OUTPUT	THERMISTOR OUTPUT	COMPUTED PRESSURE	ERROR %FSR
14.68	529945.0	1.5	14.68	0.00
179.95	592575.0	1.5	179.92	-0.00
359.94	660723.0	1.5	359.90	-0.00
539.94	728813.0	1.5	539.91	-0.00
719.93	796824.0	1.5	719.90	-0.00
874.90	855331.0	1.5	874.89	-0.00
719.95	796862.0	1.5	720.00	0.01
539.97	728851.0	1.5	540.01	0.00
359.97	660760.0	1.5	359.99	0.00
179.96	592598.0	1.5	179.98	0.00
14.69	529948.0	1.5	14.69	0.00

## THERMAL CORRECTION

TEMP ITS90	THERMISTOR OUTPUT	INST OUTPUT
32.50	1.75	530023.07
29.00	1.69	530041.09
24.00	1.60	530065.44
18.50	1.49	530093.22
15.00	1.43	530105.65
4.50	1.23	530137.68
1.00	1.16	530118.67

TEMP (ITS90)	SPAN (mV)
-5.00	25.08
35.00	25.06

$y = \text{thermistor output}; t = PTEMPA0 + PTEMPA1 * y + PTEMPA2 * y^2$

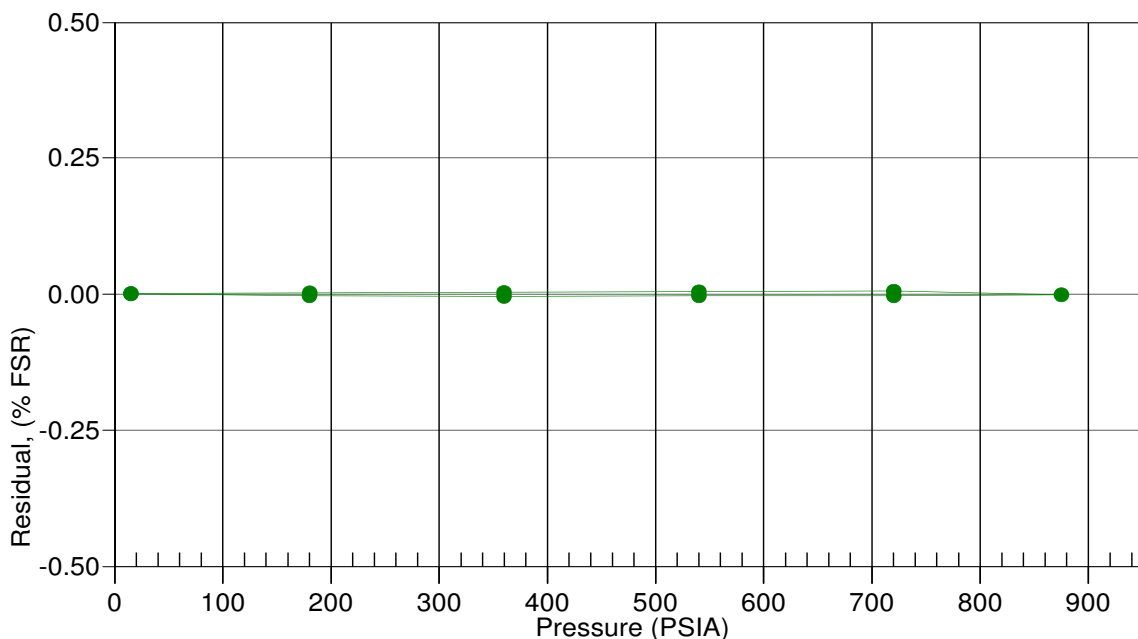
$x = \text{pressure output} - PTCA0 - PTCA1 * t - PTCA2 * t^2$

$n = x * PTCB0 / (PTCB0 + PTCB1 * t + PTCB2 * t^2)$

$\text{pressure (psia)} = PA0 + PA1 * n + PA2 * n^2$

Date, Avg Delta P %FS

26-Aug-08 0.00



# APPLIED MICROSYSTEMS

## 004986 Certificate of Calibration

Customer: NOAA - Pacific Marine Center  
Asset Serial Number: 004986  
Asset Type: 004986 (Smart SV&P)  
Calibrated Pressure Range: 1000 dBar

---

Certification Date: 02/10/2008 (dd/mm/yyyy)

Certified By:



Applied Microsystems Ltd.

Robert Haydock,  
President  
Applied Microsystems

Applied Microsystems certifies that the equipment described above has been calibrated with equipment referenced to traceable standards. Any repairs / calibrations completed on this instrument were approved by the instrument owner under purchase order.

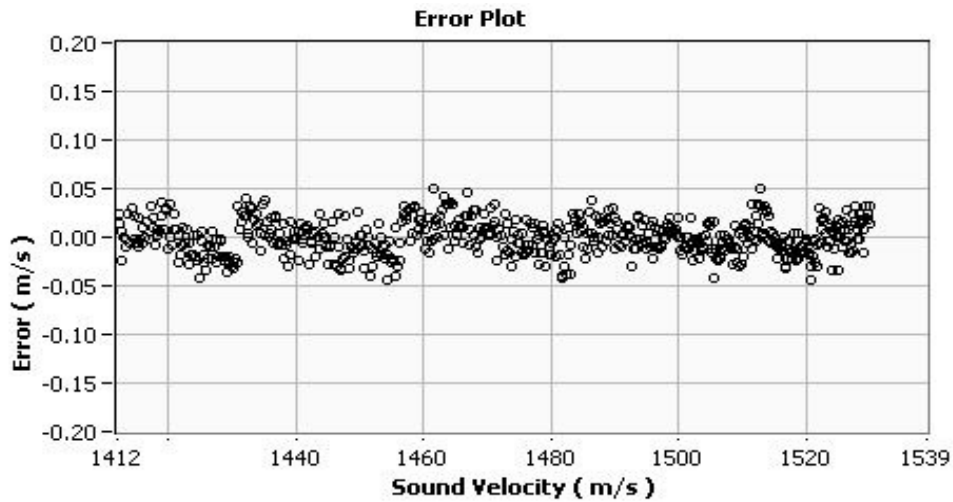
This instrument has been recalibrated. Please be sure to update your records. Please also ensure that you update the instrument's coefficient values in any post-processing software (ie. Smart Talk) that you use. Instrument configuration files are available at our Client Service & Support Portal (see web address below).

For a complete service history of this instrument, please consult our on-line Client Service & Support Portal at <http://www.appliedmicrosystems.com/customers/index.htm>



# Sound Velocity Calibration

Date: 9/23/2008  
Instrument SN: 004986  
Calibrator: Les Woodland  
RMS Error: 0.018  
Range: 1400 to 1550 m/s



$$m/s=A+B*((NH-N)/(NH-NL))+C*((NH-N)/(NH-NL))^2+D*((NH-N)/(NH-NL))^3$$

## Coefficients

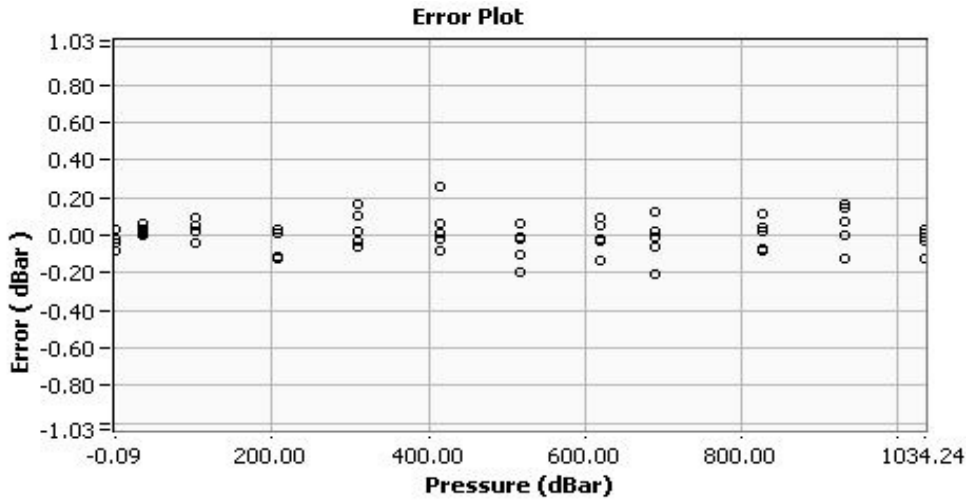
**A=1.521719E+3**  
**B=-1.065195E+2**  
**C=8.413916E+0**  
**D=-7.328216E-1**

**APPLIED** Because it's not just   
**MICROSYSTEMS**

2071 Malaview Ave West, Sidney, British Columbia, Canada V8L 5X6  
Phone: (250) 656-0771 Fax: (250) 655-3655  
Canada & USA: 800-663-8721  
Email: [info@AppliedMicrosystems.com](mailto:info@AppliedMicrosystems.com) Web: <http://www.aml.bc.ca>

# Pressure Calibration

Date ( mm/dd/yy ): 09/30/08  
Instrument SN: 004986  
Calibrator: Les Woodland  
RMS Error: 0.086  
Range: 1000 dBar



$$\text{dBar} = A + B * T + C * T^2 + D * T^3 + (E + F * T + G * T^2 + H * T^3) * \text{Raw} + (I + J * T + K * T^2 + L * T^3) * \text{Raw}^2$$

## Coefficients

**A=-1.774596E+3 G=-3.214595E-7**  
**B=9.062190E-2 H=9.150362E-9**  
**C=2.005744E-2 I=-1.404551E-8**  
**D=-3.298937E-4 J=3.282178E-10**  
**E=5.909598E-2 K=-4.517941E-12**  
**F=-7.414152E-6 L=-5.695738E-14**



2071 Malview Ave West, Sidney, British Columbia, Canada V8L 5X6  
Phone: (250) 656-0771 Fax: (250) 655-3655  
Canada & USA: 800-663-8721  
Email: [info@AppliedMicrosystems.com](mailto:info@AppliedMicrosystems.com) Web: <http://www.aml.bc.ca>

# APPLIED Because it's not just H<sub>2</sub>O MICROSYSTEMS

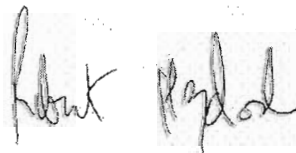
## 5229 Certificate of Calibration

Customer: NOAA - Pacific Marine Center  
Instrument Serial Number: INS-05229  
Instrument Type: Smart SV&P  
Instrument Description: Real-time instrument with sound velocity (invar) and pressure  
Calibrated Pressure Range: 1000 dBar

---

Certification Date: 08/02/2008 (dd/mm/yyyy)

Certified By:



Robert Haydock,  
General Manager  
Applied Microsystems

Applied Microsystems certifies that the equipment described above has been calibrated with equipment referenced to traceable standards. Any repairs / calibrations completed on this instrument were approved by the instrument owner under purchase order.

This instrument has been recalibrated. Please be sure to update your records. Please also ensure that you update the instrument's coefficient values in any post-processing software (ie. Smart Talk) that you use. Instrument configuration files are available at our Client Service & Support Portal (see web address below).

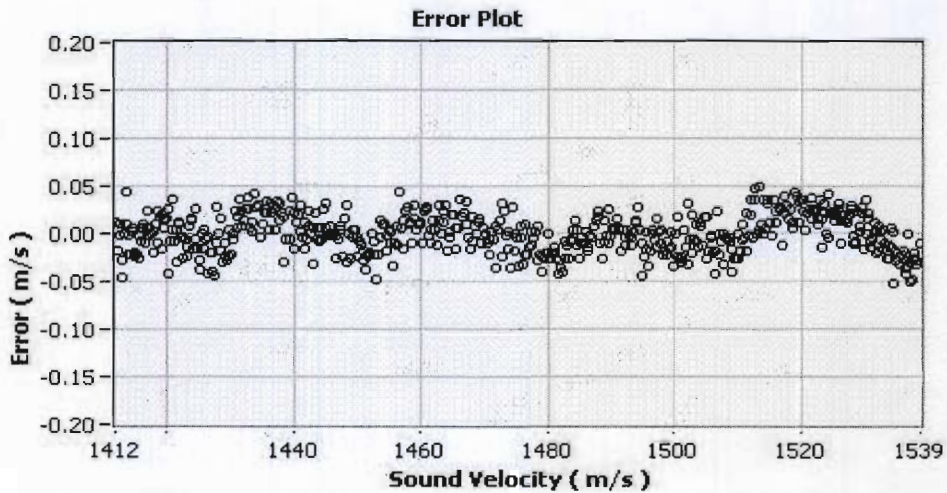
For a complete service history of this instrument, please consult our on-line Client Service & Support Portal at <http://www.appliedmicrosystems.com/customers/index.htm>

Applied Microsystems  
2071 Malaview Avenue  
Sidney, B.C. V8L 5X6 CANADA  
Tel: +1-250-656-0771 Fax: +1-250-655-3655

# Sound Velocity Calibration

Date: 2/8/2008  
Instrument SN: 005229  
Calibrator: Matt Tradewell


RMS Error: 0.020  
Range: 1400 to 1550 m/s



$$m/s=A+B*((NH-N)/(NH-NL))+C*((NH-N)/(NH-NL))^2+D*((NH-N)/(NH-NL))^3$$

## Coefficients

A=1.521988E+3  
B=-1.067986E+2  
C=8.820610E+0  
D=-9.938356E-1

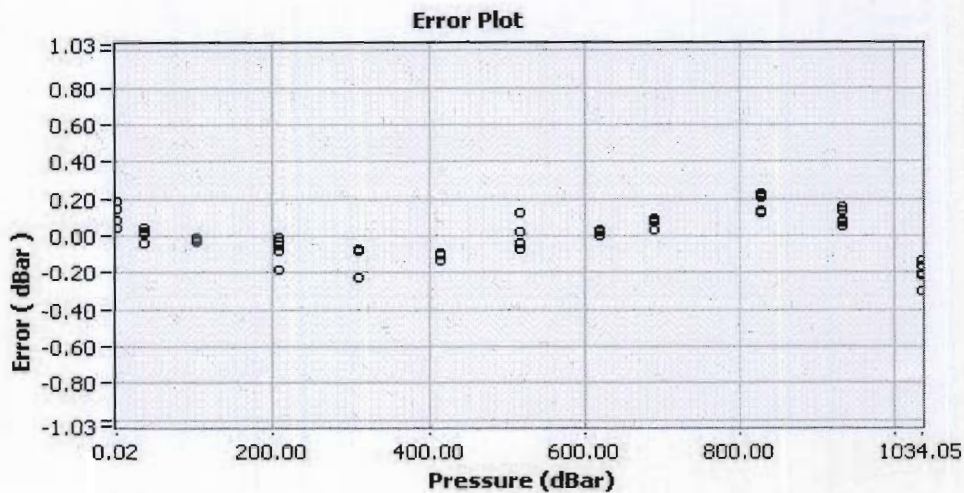
**APPLIED** Because it's not just   
**MICROSYSTEMS**

2071 Malaview Ave West, Sidney, British Columbia, Canada V8L 5X6  
Phone: (250) 656-0771 Fax: (250) 655-3655  
Canada & USA: 800-663-8721  
Email: [info@AppliedMicrosystems.com](mailto:info@AppliedMicrosystems.com) Web: <http://www.aml.bc.ca>

# Pressure Calibration

Date: 2/6/2008  
Instrument SN: 005229  
Calibrator: Matt Tradewell

RMS Error: 0.1141  
Range: 1000 dBar



$$\text{dBar} = A + B * T + C * T^2 + D * T^3 + (E + F * T + G * T^2 + H * T^3) * \text{Raw} + (I + J * T + K * T^2 + L * T^3) * \text{Raw}^2$$

## Coefficients

A=-1.468823E+3 G=2.642032E-7  
B=-4.145866E-1 H=-1.446059E-8  
C=-1.325764E-3 I=-1.195644E-9  
D=2.944354E-4 J=-5.100709E-13  
E=4.653640E-2 K=-5.746673E-12  
F=1.484535E-5 L=1.502744E-13

**APPLIED** Because it's not just H<sub>2</sub>O  
**MICROSYSTEMS**

2071 Malaview Ave West, Sidney, British Columbia, Canada V8L 5X6  
Phone: (250) 656-0771 Fax: (250) 655-3655  
Canada & USA: 800-663-8721  
Email: info@AppliedMicrosystems.com Web: <http://www.aml.bc.ca>

# APPLIED MICROSYSTEMS

## 005466 Certificate of Conformity

Customer: NOAA Ship Fairweather

Our Reference: Project 14065 NOAA Ship Fairweather; Smart SV&P-MVP (Sept-08)

Customer Purchase Order: Phone Order

Asset Serial Number: 005466

Asset Type: 005466 (Smart SV&P for Brooke MVP)

Calibrated Pressure Range: 1000 dBar

Additional Description: RS 485 communication at 19200 baud

---

Certification Date: 30/10/2008 (dd/mm/yyyy)

Certified By:

  
Applied Microsystems Ltd.

Robert Haydock,  
President  
Applied Microsystems

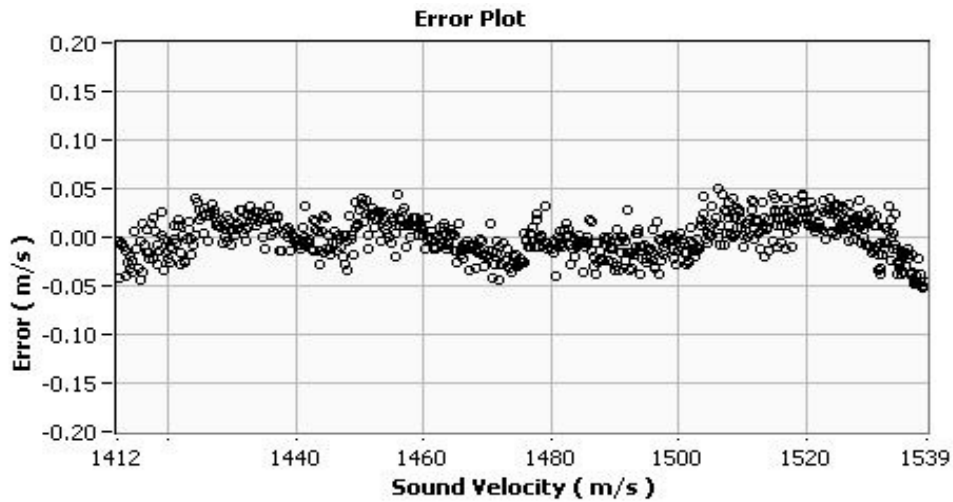
Applied Microsystems certifies that the above described equipment has been tested in accordance with the product's technical specifications, brochures, and / or relevant drawings. Applied Microsystems certifies that calibrations on this instrument have been completed with equipment reference to traceable standards.

Instrument configuration files and soft copy certificates are available at Applied Microsystems Client Service and Support Portal at <http://www.appliedmicrosystems.com/customers/index.htm>

# Sound Velocity Calibration

Date (mm/dd/yy): 30/10/08  
Instrument SN: 005466  
Calibrator: Matt Tradewell

RMS Error: 0.020  
Range: 1400 to 1550 m/s



$$m/s=A+B*((NH-N)/(NH-NL))+C*((NH-N)/(NH-NL))^2+D*((NH-N)/(NH-NL))^3$$

## Coefficients

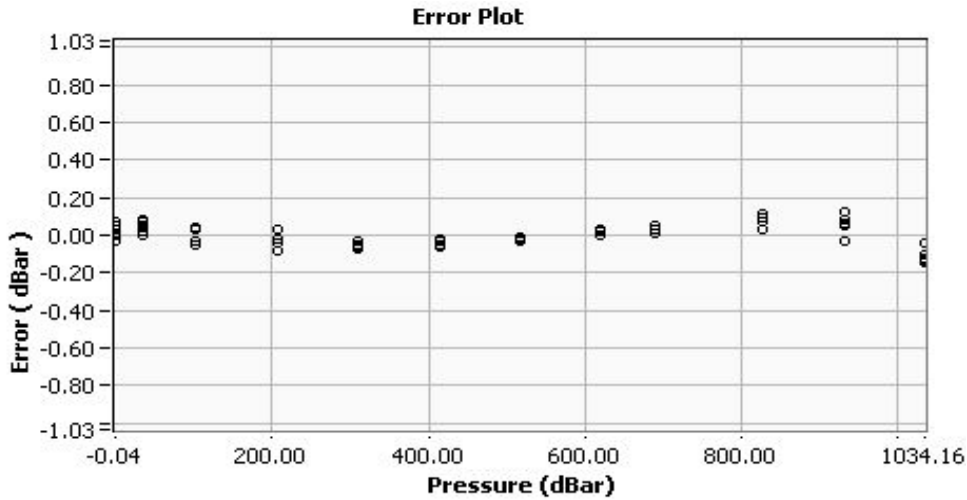
**A=1.533131E+3**  
**B=-1.137455E+2**  
**C=1.040759E+1**  
**D=-1.332106E+0**

**APPLIED** Because it's not just   
**MICROSYSTEMS**

2071 Malview Ave West, Sidney, British Columbia, Canada V8L 5X6  
Phone: (250) 656-0771 Fax: (250) 655-3655  
Canada & USA: 800-663-8721  
Email: [info@AppliedMicrosystems.com](mailto:info@AppliedMicrosystems.com) Web: <http://www.aml.bc.ca>

# Pressure Calibration

Date: 10/23/2008  
Instrument SN: 005466  
Calibrator: Matt Tradewell  
RMS Error: 0.0604  
Range: 1000 dBar



$$dBar=A+B*T+C*T^2+D*T^3+(E+F*T+G*T^2+H*T^3)*Raw+(I+J*T+K*T^2+L*T^3)*Raw^2$$

## Coefficients

**A=-1.238729E+3 G=-1.128182E-6**  
**B=-3.145002E-1 H=1.415759E-8**  
**C=3.012141E-2 I=-4.262089E-9**  
**D=-3.571170E-4 J=-1.925685E-10**  
**E=4.398952E-2 K=1.080000E-11**  
**F=2.278661E-5 L=-1.832266E-13**



2071 Malview Ave West, Sidney, British Columbia, Canada V8L 5X6  
Phone: (250) 656-0771 Fax: (250) 655-3655  
Canada & USA: 800-663-8721  
Email: [info@AppliedMicrosystems.com](mailto:info@AppliedMicrosystems.com) Web: <http://www.aml.bc.ca>



## AML Calibration Equipment

### Temperature Calibrations

Performed using either of two Hart Scientific "Black Stack" Model 1560 Power Bases with attached Hart Scientific Model 2563 Thermistor Modules connected to a Thermometrics AS125 4 Wire Thermistor Standard

1: Hart Scientific Power Base 1560 S/N 79263 / Thermistor Module 2563 S/N 79039 / Thermometrics AS125 4 Wire Thermistor Standard S/N 2131

2: Hart Scientific power Base 1560 S/N A05690 / Thermistor Module 2563 S/N A05693 / Thermometrics AS125 4 Wire Thermistor Standard S/N 2128

Temperature calibration equipment is calibrated yearly and verified bi-monthly as per Applied Microsystems Ltd. Calibration Schedule T11.2 utilizing a Hart Scientific Model 5901 Triple Point of Water Cell. All temperature calibrations and verifications are ITS-90 and NIST traceable

### Pressure Calibrations

Performed using a Budenburg Model 380D S/N 18564 Range 0-8000 psi Deadweight Tester. Calibrations and verifications are implemented as per Applied Microsystems Ltd. Calibration Schedule T11.2. All pressure calibrations and verifications are NIST traceable.

### Conductivity Calibrations

Performed using either of two Guildline 8400B S/N 59251 or Guildline 8400 S/N 43385 Autosals. Both Conductivity Calibrators are calibrated and verified using Ocean Scientific International IAPSO Standard Seawater as per Applied Microsystems Ltd. Calibration Schedule T11.2. All Conductivity Calibrations and verifications are NIST traceable

### Battery Channel Calibrations

Performed using a Precision Fluke Model 45 Multimeter S/N 4720162. Calibrations and verifications are implemented as per Applied Microsystems Ltd. Calibration Schedule T11.2 All calibrations and verifications are NIST traceable.

### Sound Velocity Calibrations

Performed using an Applied Microsystems Ltd Temperature Standard S/N 9998 in distilled water, <5 ppm TDS, and sound velocity reference is Del Grosso and Mader's Pure Water Equation. Calibrations and verifications are implemented as per Applied Microsystems Ltd. Calibration Schedule T11.2 All temperature calibrations and verifications are ITS-90 and NIST traceable.



# SVP Test and Calibration certificate

SVP Type :	SVP70
SVP Serial No.	4008077

Date of issue :	01-04-2009
-----------------	------------

Functionality Test : Sign : \_\_\_\_\_

<b>Temperature Calibration :</b>	Hart 1504 s/n A6B554 & Thermistor s/n 3014
<b>Point 1:</b>	4.6 °C
<b>Point 2:</b>	16.5 °C
<b>Point 3:</b>	25.5 °C
<b>Pressure Calibration :</b>	Custom Built Tank (TestUnit ASF150 Ser# 41-10-0007-R03)
<b>Point 1:</b>	0 Bar
<b>Point 2:</b>	301.7 Bar
<b>Point 3:</b>	603.6 Bar

**RMS Speed of Sound Errors**

Temperature Validation :	0.0033 m/s
Pressure Validation :	0.0845 m/s

Calibration Completed : Sign : \_\_\_\_\_

Final Function Test : Sign : \_\_\_\_\_

QA Signature : Inits : \_\_\_\_\_



# SEA-BIRD ELECTRONICS, INC.

1808 136th Place N.E., Bellevue, Washington, 98005 USA

Phone: (425) 643 - 9866 Fax (425) 643 - 9954 Email: seabird@seabird.com

SENSOR SERIAL NUMBER: 0117  
CALIBRATION DATE: 08-Jan-08

SBE 45 CONDUCTIVITY CALIBRATION DATA  
PSS 1978: C(35,15,0) = 4.2914 Siemens/meter

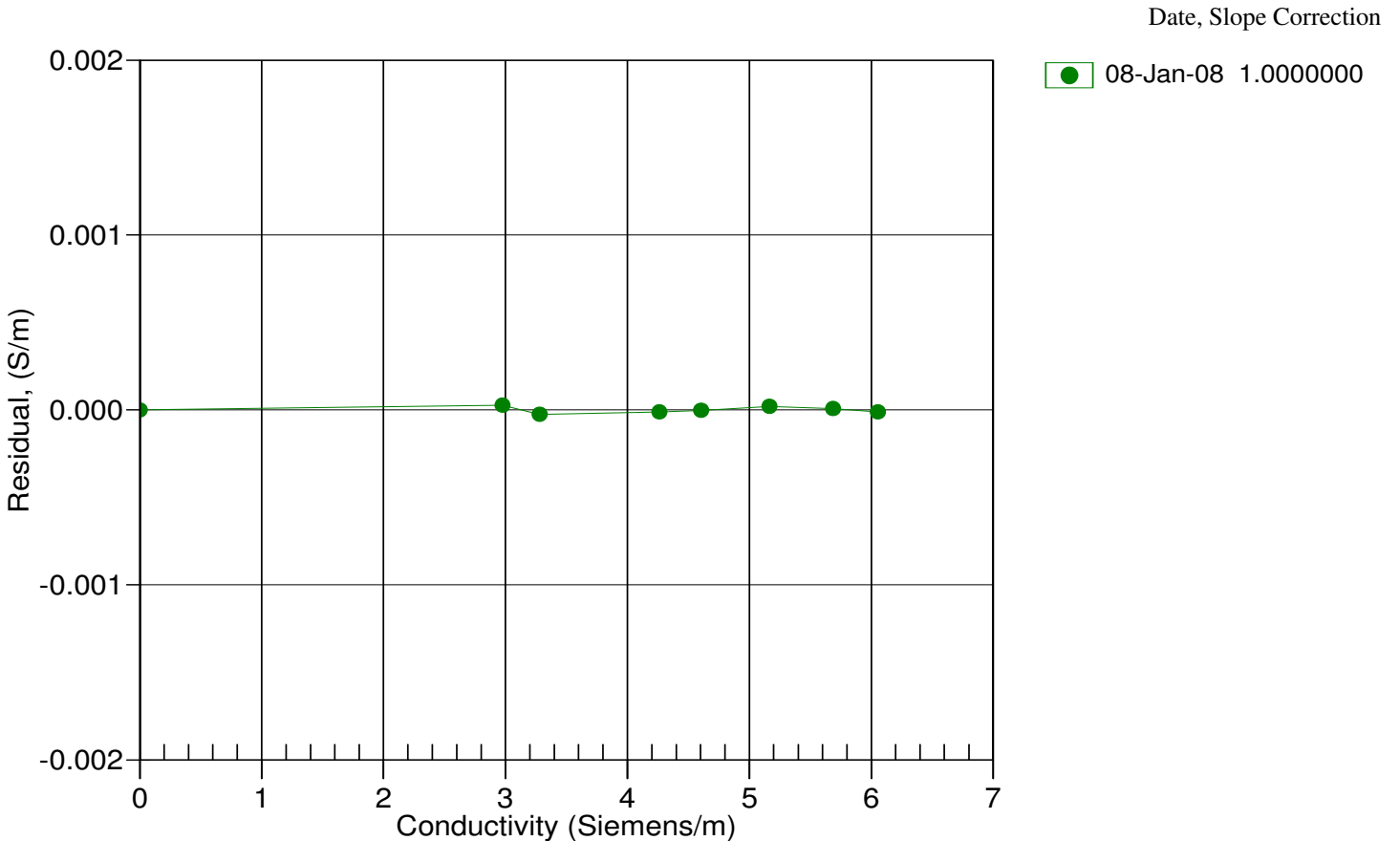
**COEFFICIENTS:**

g = -1.031942e+000	CPcor = -9.5700e-008
h = 1.269033e-001	CTcor = 3.2500e-006
i = -2.218276e-004	WBOTC = -3.1803e-006
j = 3.318496e-005	

BATH TEMP (ITS-90)	BATH SAL (PSU)	BATH COND (Siemens/m)	INST FREQ (Hz)	INST COND (Siemens/m)	RESIDUAL (Siemens/m)
22.0000	0.0000	0.00000	2855.80	0.00000	0.00000
1.0000	34.7807	2.97321	5622.31	2.97324	0.00003
4.4999	34.7610	3.28001	5832.94	3.27999	-0.00003
14.9999	34.7176	4.26078	6459.57	4.26076	-0.00001
18.5000	34.7080	4.60555	6665.57	4.60555	-0.00000
24.0000	34.6969	5.16282	6985.35	5.16285	0.00002
29.0000	34.6902	5.68399	7271.30	5.68399	0.00001
32.4999	34.6851	6.05568	7468.33	6.05567	-0.00001

$f = \text{INST FREQ} * \text{sqrt}(1.0 + \text{WBOTC} * t) / 1000.0$   
 Conductivity =  $(g + hf^2 + if^3 + jf^4) / (1 + \delta t + \epsilon p)$  Siemens/meter  
 t = temperature[°C]; p = pressure[decibars];  $\delta = \text{CTcor}$ ;  $\epsilon = \text{CPcor}$ ;

Residual = instrument conductivity - bath conductivity



# SEA-BIRD ELECTRONICS, INC.

1808 136th Place N.E., Bellevue, Washington, 98005 USA

Phone: (425) 643 - 9866 Fax (425) 643 - 9954 Email: seabird@seabird.com

SENSOR SERIAL NUMBER: 0117  
CALIBRATION DATE: 11-Dec-07

SBE 45 CONDUCTIVITY CALIBRATION DATA  
PSS 1978: C(35,15,0) = 4.2914 Siemens/meter

**COEFFICIENTS:**

g = -1.029836e+000	CPcor = -9.5700e-008
h = 1.264890e-001	CTcor = 3.2500e-006
i = -1.244736e-004	WBOTC = -3.1803e-006
j = 2.698268e-005	

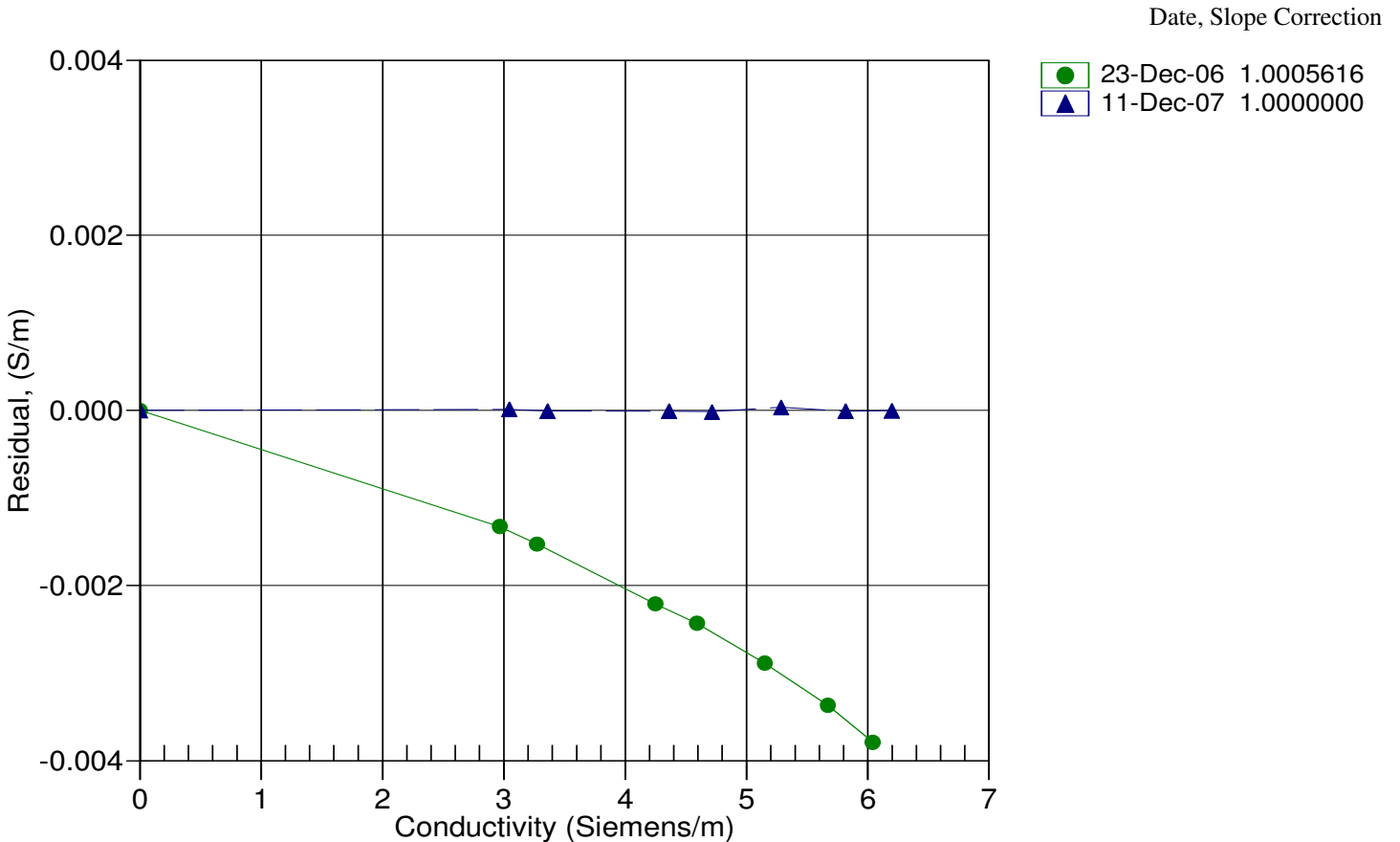
BATH TEMP (ITS-90)	BATH SAL (PSU)	BATH COND (Siemens/m)	INST FREQ (Hz)	INST COND (Siemens/m)	RESIDUAL (Siemens/m)
22.0000	0.0000	0.00000	2854.99	0.00000	0.00000
1.0000	35.7009	3.04425	5671.69	3.04426	0.00001
4.5000	35.6792	3.35798	5885.14	3.35797	-0.00001
15.0000	35.6327	4.36100	6519.96	4.36099	-0.00001
18.5000	35.6226	4.71361	6728.60	4.71359	-0.00002
23.9999	35.6111	5.28357	7052.48	5.28361	0.00003
29.0000	35.6023	5.81635	7341.91	5.81634	-0.00001
32.5001	35.5947	6.19615	7541.26	6.19615	-0.00000

$$f = \text{INST FREQ} * \text{sqrt}(1.0 + \text{WBOTC} * t) / 1000.0$$

$$\text{Conductivity} = (g + hf^2 + if^3 + jf^4) / (1 + \delta t + \epsilon p) \text{ Siemens/meter}$$

t = temperature[°C]; p = pressure[decibars];  $\delta$  = CTcor;  $\epsilon$  = CPcor;

Residual = instrument conductivity - bath conductivity



# SEA-BIRD ELECTRONICS, INC.

1808 136th Place N.E., Bellevue, Washington, 98005 USA

Phone: (425) 643 - 9866 Fax (425) 643 - 9954 Email: seabird@seabird.com

SENSOR SERIAL NUMBER: 0117  
CALIBRATION DATE: 08-Jan-08

SBE 45 TEMPERATURE CALIBRATION DATA  
ITS-90 TEMPERATURE SCALE

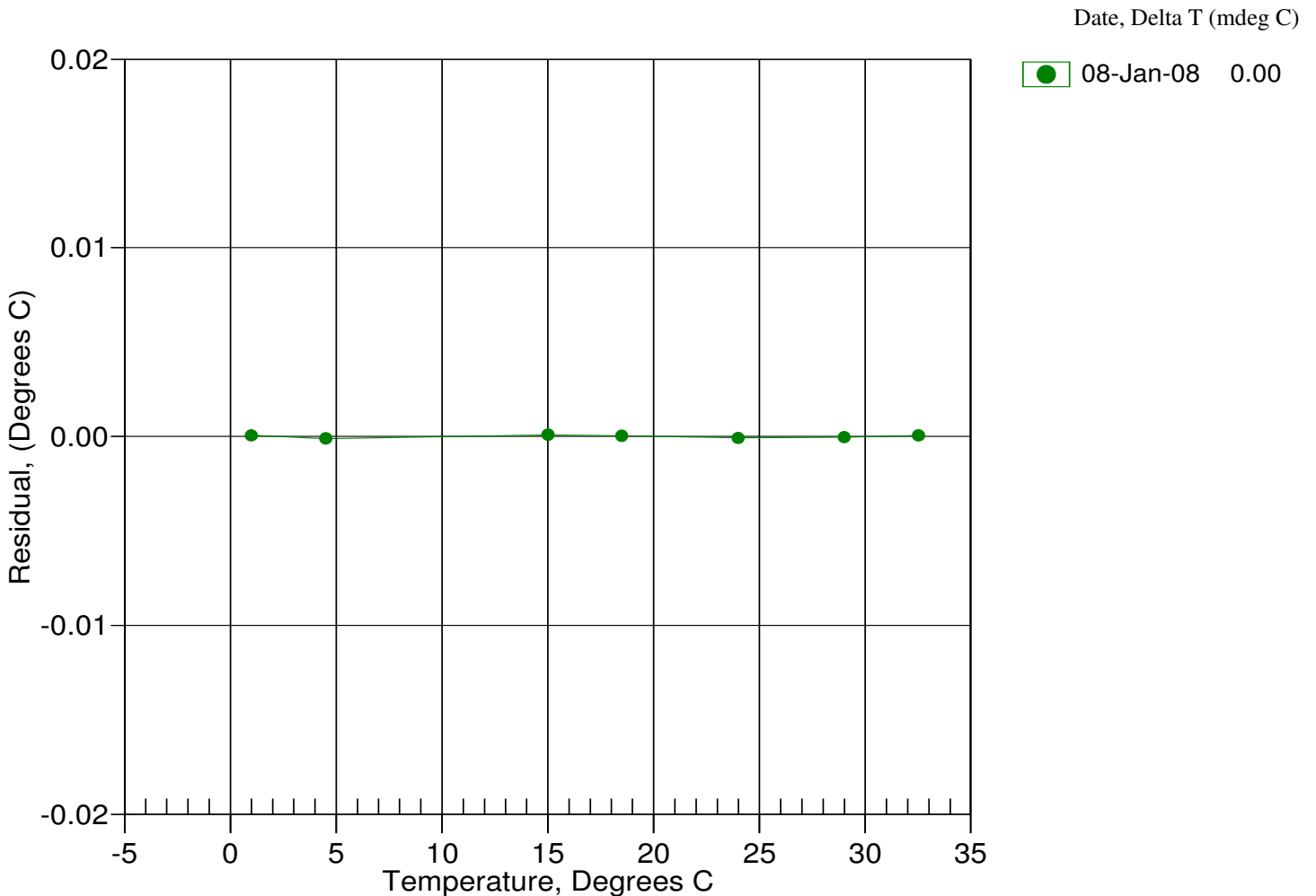
## ITS-90 COEFFICIENTS

a0 = -2.444687e-004  
a1 = 3.101067e-004  
a2 = -4.608202e-006  
a3 = 2.066460e-007

BATH TEMP (ITS-90)	INSTRUMENT OUTPUT	INST TEMP (ITS-90)	RESIDUAL (ITS-90)
1.0000	825687.0	1.0001	0.0001
4.4999	708009.0	4.4998	-0.0001
14.9999	455003.1	15.0000	0.0001
18.5000	395051.1	18.5000	0.0000
24.0000	318250.6	23.9999	-0.0001
29.0000	263033.5	29.0000	-0.0000
32.4999	230938.9	32.4999	0.0000

Temperature ITS-90 =  $1 / \{ a_0 + a_1[\ln(n)] + a_2[\ln^2(n)] + a_3[\ln^3(n)] \} - 273.15$  (°C)

Residual = instrument temperature - bath temperature



# SEA-BIRD ELECTRONICS, INC.

1808 136th Place N.E., Bellevue, Washington, 98005 USA

Phone: (425) 643 - 9866 Fax (425) 643 - 9954 Email: seabird@seabird.com

SENSOR SERIAL NUMBER: 0117  
CALIBRATION DATE: 11-Dec-07

SBE 45 TEMPERATURE CALIBRATION DATA  
ITS-90 TEMPERATURE SCALE

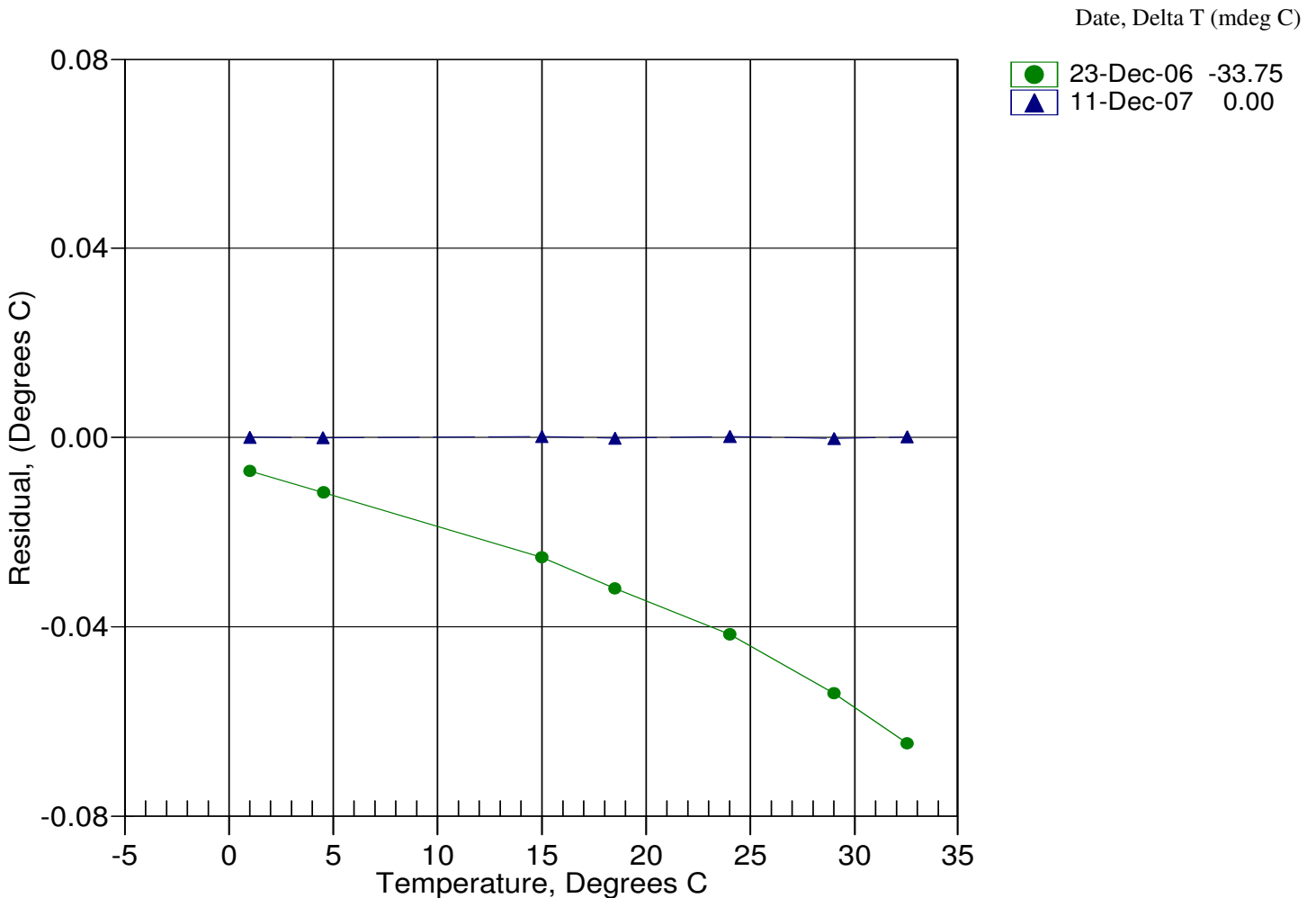
## ITS-90 COEFFICIENTS

a0 = -1.865866e-004  
a1 = 2.970047e-004  
a2 = -3.621420e-006  
a3 = 1.819198e-007

BATH TEMP (ITS-90)	INSTRUMENT OUTPUT	INST TEMP (ITS-90)	RESIDUAL (ITS-90)
1.0000	825650.8	1.0001	0.0001
4.5000	707981.6	4.4999	-0.0001
15.0000	455000.0	15.0002	0.0002
18.5000	395058.3	18.4998	-0.0002
23.9999	318252.4	24.0001	0.0002
29.0000	263036.0	28.9998	-0.0002
32.5001	230933.8	32.5002	0.0001

Temperature ITS-90 =  $1/\{a_0 + a_1[\ln(n)] + a_2[\ln^2(n)] + a_3[\ln^3(n)]\} - 273.15$  (°C)

Residual = instrument temperature - bath temperature





# SEA-BIRD ELECTRONICS, INC.

1808 - 136th Place Northeast, Bellevue, Washington 98005 USA

Phone: (425) 643-9866 Fax: (425) 643-9954 www.seabird.com

## Conductivity Calibration Report

Customer:	Pacific Marine Center / NOAA		
Job Number:	48749	Date of Report:	1/8/2008
Model Number:	SBE 45	Serial Number:	4536628-0117

*Conductivity sensors are normally calibrated 'as received', without cleaning or adjustments, allowing a determination of sensor drift. If the calibration identifies a problem or indicates cell cleaning is necessary, then a second calibration is performed after work is completed. The 'as received' calibration is not performed if the sensor is damaged or non-functional, or by customer request.*

*An 'as received' calibration certificate is provided, listing the coefficients used to convert sensor frequency to conductivity. Users must choose whether the 'as received' calibration or the previous calibration better represents the sensor condition during deployment. In SEASOFT enter the chosen coefficients using the program SEACON. The coefficient 'slope' allows small corrections for drift between calibrations (consult the SEASOFT manual). Calibration coefficients obtained after a repair or cleaning apply only to subsequent data.*

'AS RECEIVED CALIBRATION'  Performed  Not Performed

Date:  Drift since last cal:  PSU/month\*

Comments:

'CALIBRATION AFTER REPAIR'  Performed  Not Performed

Date:  Drift since Last cal:  PSU/month\*

Comments:

*\*Measured at 3.0 S/m*

*Cell cleaning and electrode replatinizing tend to 'reset' the conductivity sensor to its original condition. Lack of drift in post-cleaning-calibration indicates geometric stability of the cell and electrical stability of the sensor circuit.*



# SEA-BIRD ELECTRONICS, INC.

1808 - 136th Place Northeast, Bellevue, Washington 98005 USA

Phone: (425) 643-9866 Fax: (425) 643-9954 www.seabird.com

## Temperature Calibration Report

<b>Customer:</b>	Pacific Marine Center / NOAA		
<b>Job Number:</b>	48749	<b>Date of Report:</b>	1/8/2008
<b>Model Number</b>	SBE 45	<b>Serial Number:</b>	4536628-0117

*Temperature sensors are normally calibrated 'as received', without adjustments, allowing a determination sensor drift. If the calibration identifies a problem, then a second calibration is performed after work is completed. The 'as received' calibration is not performed if the sensor is damaged or non-functional, or by customer request.*

*An 'as received' calibration certificate is provided, listing coefficients to convert sensor frequency to temperature. Users must choose whether the 'as received' calibration or the previous calibration better represents the sensor condition during deployment. In SEASOFT enter the chosen coefficients using the program SEACON. The coefficient 'offset' allows a small correction for drift between calibrations (consult the SEASOFT manual). Calibration coefficients obtained after a repair apply only to subsequent data.*

'AS RECEIVED CALIBRATION'  Performed  Not Performed

---

Date:  Drift since last cal:  Degrees Celsius/year

Comments:

'CALIBRATION AFTER REPAIR'  Performed  Not Performed

---

Date:  Drift since Last cal:  Degrees Celsius/year

Comments:



Date:  
Apr 16, 2009

# DIGIBAR CALIBRATION REPORT

version 1.0 (c) 2004

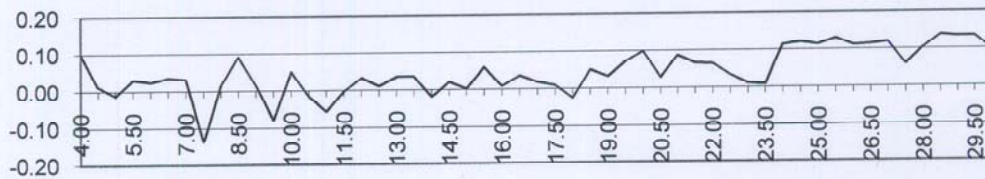
Serial #:  
98013-041609

ODOM HYDROGRAPHIC SYSTEMS, Inc.



## STANDARD DEL GROSSO H<sup>2</sup>O

TEMP	VELOCITY	MEASURED	RES_VEL	OBS-CAL	TEMP	VELOCITY	MEASURED	RES_VEL	OBS-CAL
FREQUENCY					FREQUENCY				
4.00	1421.62	5555.38	1421.72	0.10	17.50	1474.38	5754.23	1474.39	0.01
4.50	1423.90	5563.65	1423.91	0.01	18.00	1476.01	5760.25	1475.98	-0.03
5.00	1426.15	5572.06	1426.14	-0.01	18.50	1477.62	5766.61	1477.67	0.05
5.50	1428.38	5580.63	1428.41	0.03	19.00	1479.21	5772.53	1479.24	0.03
6.00	1430.58	5588.91	1430.60	0.02	19.50	1480.77	5778.59	1480.84	0.07
6.50	1432.75	5597.16	1432.79	0.04	20.00	1482.32	5784.53	1482.42	0.10
7.00	1434.90	5605.25	1434.93	0.03	20.50	1483.84	5790.02	1483.87	0.03
7.50	1437.02	5612.62	1436.88	-0.14	21.00	1485.35	5795.92	1485.43	0.09
8.00	1439.12	5621.12	1439.13	0.02	21.50	1486.83	5801.44	1486.89	0.07
8.50	1441.19	5629.22	1441.28	0.09	22.00	1488.29	5806.96	1488.36	0.06
9.00	1443.23	5636.66	1443.25	0.02	22.50	1489.74	5812.30	1489.77	0.03
9.50	1445.25	5643.93	1445.18	-0.08	23.00	1491.16	5817.59	1491.17	0.01
10.00	1447.25	5651.96	1447.30	0.05	23.50	1492.56	5822.88	1492.57	0.01
10.50	1449.22	5659.15	1449.21	-0.02	24.00	1493.95	5828.51	1494.06	0.11
11.00	1451.17	5666.35	1451.11	-0.06	24.50	1495.32	5833.69	1495.44	0.12
11.50	1453.09	5673.82	1453.09	0.00	25.00	1496.66	5838.75	1496.78	0.11
12.00	1454.99	5681.13	1455.03	0.03	25.50	1497.99	5843.82	1498.12	0.13
12.50	1456.87	5688.13	1456.88	0.01	26.00	1499.30	5848.69	1499.41	0.11
13.00	1458.72	5695.22	1458.76	0.04	26.50	1500.59	5853.57	1500.70	0.11
13.50	1460.55	5702.13	1460.59	0.04	27.00	1501.86	5858.39	1501.98	0.12
14.00	1462.36	5708.74	1462.34	-0.02	27.50	1503.11	5862.89	1503.17	0.06
14.50	1464.14	5715.63	1464.17	0.02	28.00	1504.35	5867.72	1504.45	0.10
15.00	1465.91	5722.21	1465.91	0.00	28.50	1505.56	5872.44	1505.70	0.14
15.50	1467.65	5728.99	1467.70	0.06	29.00	1506.76	5876.95	1506.89	0.13
16.00	1469.36	5735.28	1469.37	0.01	29.50	1507.94	5881.41	1508.08	0.13
16.50	1471.06	5741.78	1471.09	0.04	30.00	1509.10	5885.67	1509.20	0.10
17.00	1472.73	5748.03	1472.75	0.02					



### Odom Hydrographic Systems, Inc.

1450 SeaBoard Avenue, Baton Rouge, Louisiana 70810-6261, USA

Telephone: (225)-769-3051, Facsimile: (225)-766-5122

E-mail: email@odomhydrographic.com, HTTP: www.odomhydrographic.com

Date:  
Apr 16, 2009

Serial #:  
98013-041609

## DIGIBAR CALIBRATION REPORT

version 1.0 (c) 2004

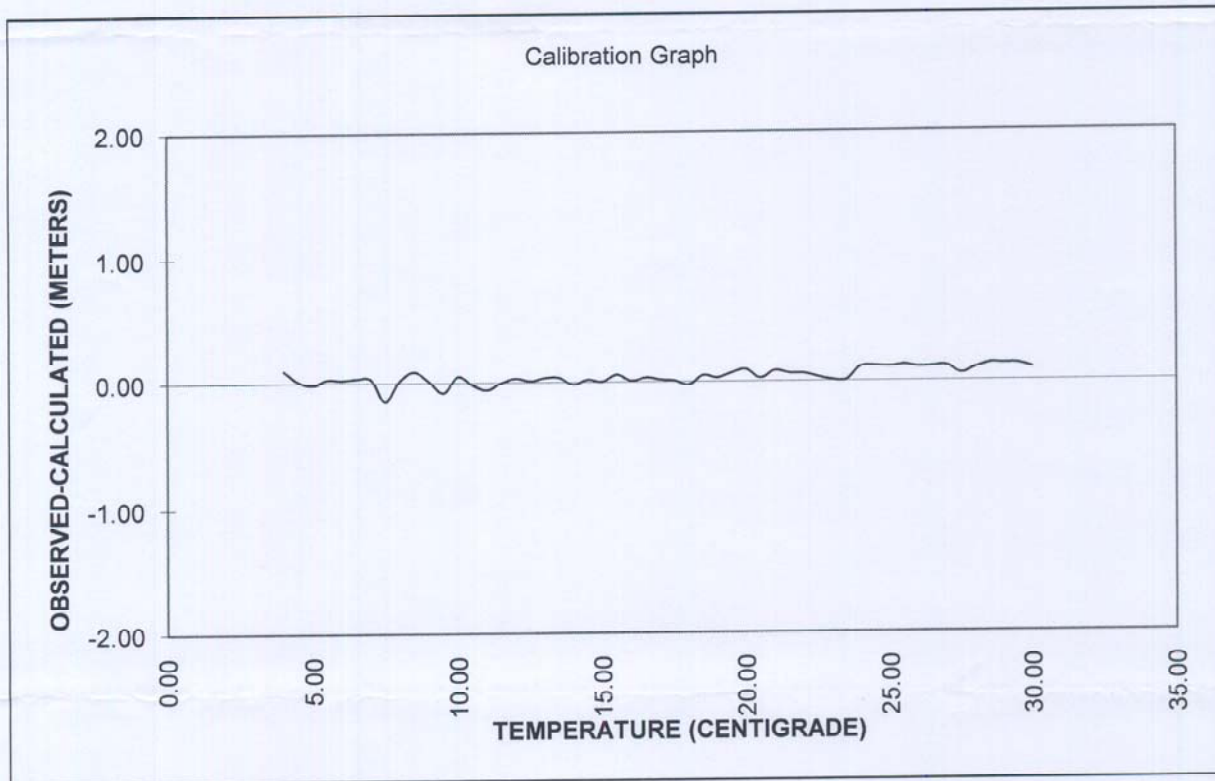
ODOM HYDROGRAPHIC SYSTEMS, Inc.



Burn these numbers to EPROM:

Gradient  
Intercept

3391  
497



The instruments used in this calibration have been calibrated to the published manufacturer specifications using standards traceable to NIST, to consensus standards, to ratio methods, or to acceptable values of natural physical constants that meets the requirements of ANSI/NCSL Z540-1, ISO 9001, ISO 10012 and ISO 17025. Certificate/traceability numbers: 0002-2655.00-23491-001, 0002-2655.00-23491-002. ID#s:294,295,762,172,56



### Odom Hydrographic Systems, Inc.

1450 SeaBoard Avenue, Baton Rouge, Louisiana 70810-6261, USA  
Telephone: (225)-769-3051, Facsimile: (225)-766-5122  
E-mail: [email@odomhydrographic.com](mailto:email@odomhydrographic.com), [HTTP: www.odomhydrographic.com](http://www.odomhydrographic.com)



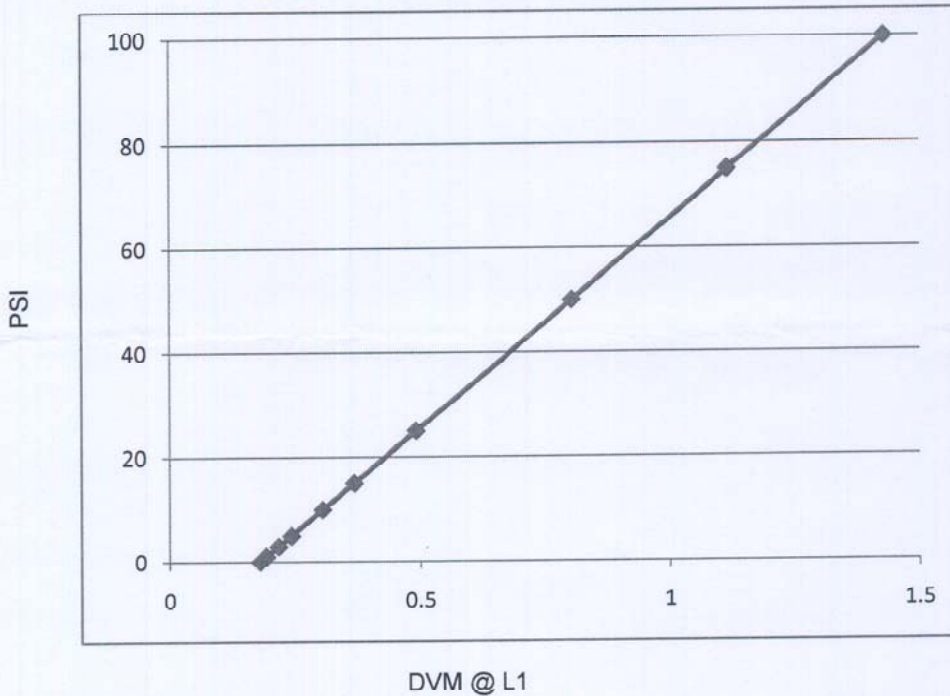
Date	4/17/2009
Serial #	98013
SW Version	1.11
Cable Length	20 meters

Press Transducer	79842
Zero Voltage	.18
Span Voltage	2.68
Mid-Scale Voltage	1.43
R5	3.9K
R9	10K
Gradient	3391
Intercept	497

Max psi:	200 psi
Velocity Check:	√
Depth Check:	√
Communications:	√
External Power:	NA

Board Identification	Serial #
Power Supply	
Control PCB	
LCD	
Probe Sensor	
Probe Controller	
Airmar Transducer	853906

Pressure Transducer Linearity



Transducer Linearity	
PSI	DVM@L1
0	0.18
1	0.192
3	0.217
5	0.242
10	0.304
15	0.367
25	0.491
50	0.804
75	1.116
100	1.43



## Certificate of Calibration

Model: Nikon DTM310

Serial Number: 842575

This certifies that the above instrument has been inspected and calibrated by the GeoLine Positioning Systems Inc. Service Department. At the time of completion of this service, GeoLine Positioning Systems, Inc. certifies that the above stated product meets all factory specifications and tolerances for product parameters and performance of this product model.

All product calibration and specification parameters were tested and/or adjusted using applicable factory calibration jigs, precision optical collimation systems and electronic test equipment. All collimation systems have been properly checked and calibrated according to industry standard practices. All electronic test equipment used have had current calibration.

Date of Calibration: 6/28/04

Next Recommended Calibration Date: 12/28/04

Signed: *Sean Visher* Date: 6/28/04

Title: Service Technician

GeoLine Positioning Systems, Inc.  
1331 118th Avenue SE, Suite 400  
Bellevue, WA 98005  
425.452.2711 • 425.452.2703 fax



## Certificate of Calibration

Model: Sokkia SET 5F

Serial Number: 16288

This certifies that the above instrument has been inspected and calibrated by the GeoLine Positioning Systems Inc. Service Department. At the time of completion of this service, GeoLine Positioning Systems, Inc. certifies that the above stated product meets all factory specifications and tolerances for product parameters and performance of this product model.

All product calibration and specification parameters were tested and/or adjusted using applicable factory calibration jigs, precision optical collimation systems and electronic test equipment. All collimation systems have been properly checked and calibrated according to industry standard practices. All electronic test equipment used have had current calibration.

Date of Calibration: 7/19/04

Next Recommended Calibration Date: 7/19/05

Signed: *Sean Vaker* Date: 7/19/04

Title: Service Technician

GeoLine Positioning Systems, Inc.  
1331 118th Avenue SE, Suite 400  
Bellevue, WA 98005  
425.452.2711 • 425.452.2703 fax

## **Appendix VI**

---

### **Correspondence**

- **PPK DDSSM Permission**
- **FA Hydrographic Resolution Waiver Request**
- **FA Hydrographic Resolution Waiver Acceptance**

----- Original Message -----

From Briana.Welton@noaa.gov  
Date Thu, 23 Apr 2009 17:06:02 -0700  
To CO.Fairweather@noaa.gov, XO.Fairweather@noaa.gov  
Subject Fwd: Re: Dynamic draft using PPK

----- Original Message -----

From Olivia.Hauser@noaa.gov  
Date Thu, 23 Apr 2009 09:14:31 -0700  
To Olivia Hauser <Olivia.Hauser@noaa.gov>  
Cc Edward.J.Vandenameele@noaa.gov, "Jack L. Riley" <Jack.Riley@noaa.gov>, Glen Rice <Glen.Rice@noaa.gov>, Grant Froelich <Grant.Froelich@noaa.gov>, Steve Brodet <Steve.Brodet@noaa.gov>, FOO.Thomas.Jefferson@noaa.gov, FOO Rainier <FOO.Rainier@noaa.gov>, FOO.Fairweather@noaa.gov, Briana Welton <Briana.Welton@noaa.gov>, 'Corey Allen' <Corey.Allen@noaa.gov>  
Subject Re: Dynamic draft using PPK

Hello All,

I spoke with EJ who conferred with Jeff Ferguson and they both agreed that if you decide to use the PPK method to determine dynamic draft on your vessel, include it in the HSRRs with the following information and they will be approved. Please include a statement that it is a deviation from the FPM, what you did to get your values and a comparison to either previous dynamic draft tables or one obtained concurrently using an approved method. (Basically the write-ups you already have). The HSRRs will be approved with the deviation, and we'll work on getting the FPM updated for next year.

V/R, Olivia

----- Original Message -----

From: Olivia Hauser <olivia.hauser@noaa.gov>  
Date: Tuesday, April 21, 2009 12:08 pm  
Subject: Dynamic draft using PPK  
To: edward.j.vandenameele@noaa.gov, "Jack L. Riley" <Jack.Riley@noaa.gov>, Glen Rice <Glen.Rice@noaa.gov>, Grant Froelich <Grant.Froelich@noaa.gov>, Steve Brodet <Steve.Brodet@noaa.gov>, foo.thomas.jefferson@noaa.gov, FOO Rainier <FOO.Rainier@noaa.gov>, foo.fairweather@noaa.gov, Briana Welton <Briana.Welton@noaa.gov>, 'Corey Allen' <Corey.Allen@noaa.gov>

> LCDR van den Ameele,  
>  
> This is a follow-up to our phone conversation the other day. Both FA  
> and  
> RA have tested the use of PPK to determine the dynamic draft for  
> their  
> vessels with positive results. Currently the FPM states that this is  
> not  
> a valid method to determine dynamic draft. Can we change that? I have  
>  
> attached the two write ups/reports that were created from these  
> tests.  
> The only major item of concern here is the removal of tide. Both of  
> the  
> test cases were conducted in areas where tide is negligible which

> made  
> the use of this data easy. It may not be as simple in areas with  
> large  
> tidal fluctuations. Is there a way we can remove tide from the SBET  
> (Jack or Steve)? Also, ENS Rice wrote the python script that created  
> the  
> final curves and graphs in both reports. It might be in our best  
> interest to include these in pydro or provide them in another form to  
>  
> all the field units if they decide to use this method.  
>  
> I recommend that we change the FPM to include this method as an  
> acceptable method to calculate dynamic draft.  
>  
> V/R, Olivia  
>  
> --  
> LTJG Olivia Hauser  
> NOAA HSTP Field Support Liaison, East  
> 439 W. York Street, Norfolk, VA 23510  
> Voice: 757-441-6319 x 105  
> Fax: 757-441-6601  
> Cell: 302-229-3368  
> olivia.hauser@noaa.gov  
>





**UNITED STATES DEPARTMENT OF COMMERCE**

National Oceanic and Atmospheric Administration  
NOAA Marine and Aviation Operations  
NOAA Ship *Fairweather* S-220  
1010 Stedman Street  
Ketchikan, AK 99901

May 8, 2009

MEMORANDUM FOR: Jeffery Ferguson  
Chief, Hydrographic Surveys Division

FROM: CDR Douglas D. Baird, Jr., NOAA  
Commanding Officer, NOAA Ship *Fairweather*

SUBJECT: Waiver from HTD 2009-02 specifications

*Fairweather* personnel have examined 2009 reference surface and project related data with the Hydrographic Technical Directive 2009-02 CUBE criteria and specifications in mind, and have determined that adhering to those specifications would be an onerous task.

In order to meet the HTD 2009-02 criteria for complete coverage surveys for the 2, 4, & 8 meter grid resolutions the survey launches would have to clutch-in and clutch-out of gear to move slowly enough and the ship would be reduced to bare steerage and significantly reduced swath coverages.

I am willing to slow the platforms down to six knots speed over ground – this is just a touch over clutch-in speed on *Fairweather*'s two survey launches, and allows the ship to maintain positive control for most conditions. And we will reduce the swath coverage to 50° off nadir to both port and starboard.

I propose the following grid resolutions for the 2009 calendar year projects, using at least 5 soundings per node, at 6 knots, displaying 50° off nadir:

0 to 23 meters ..... 1 meter grid resolution  
18 to 40 meters ..... 2 meter grid resolution  
35 to 80 meters ..... 4 meter grid resolution  
75 to 160 meters ..... 8 meter grid resolution  
155+ meters ..... 16 meter grid resolution

Since it is very rare for *Fairweather* to be required to conduct object detection surveys, this waiver request is strictly for complete coverage multibeam surveys.





UNITED STATES DEPARTMENT OF COMMERCE  
National Oceanic and Atmospheric Administration  
NATIONAL OCEAN SERVICE  
Office of Coast Survey  
Silver Spring, Maryland 20910-3282

19 May 2009

MEMORANDUM FOR: Commander Douglas D. Baird Jr., NOAA  
Commanding Officer, NOAA Ship *Fairweather*

FROM: Jeffrey Ferguson  
Chief, Hydrographic Surveys Division

SUBJECT: Waiver from HTD 2009-02 Specifications

The NOAA Ship *Fairweather's* waiver, dated May 8, 2009, requesting a departure from the grid resolution requirements specified in Hydrographic Technical Directive 2009-02 is approved.

The NOAA Ship *Fairweather* will use the following grid resolutions for complete coverage multibeam on 2009 calendar year surveys, obtaining at least 5 soundings per node:

0 to 23 meters.....1 meter grid resolution  
18 to 40 meters.....2 meter grid resolution  
35 to 80 meters.....4 meter grid resolution  
75 to 160 meters.....8 meter grid resolution  
155+ meters.....16 meter grid resolution

cc Chiefs; OPS, PHB, AHB

