

DATA ACQUISITION AND PROCESSING REPORT

NRT7 (s3004)

Team Leader: Lieutenant Junior Grade Briana Welton, NOAA

Applicable Surveys

S-E926-NRT7-07

F00549

NEWPORT NEWS POINT, HAMPTON ROADS, VA

OPR-E350-NRT7-08

H11788

APPROACH TO YORK RIVER, VA

A. EQUIPMENT

All survey data acquired by Navigation Response Team Seven (NRT7) were acquired with Survey Vessel s3004. Vessel s3004 has one sonar mounting arm on the starboard side of the vessel from which only one of the Unit's two sonar systems—Reson 8125 multibeam echosounder (MBES) and Klein Light Weight 5000 side scan sonar (SSS)—are mounted at a given time. The dry hardware (Klein TPU and Reson 8P) are mounted in the cabin rack with all cables run such that changing sonar requires only exchange and connection of the transducer heads. The Odom CV vertical beam echosounder (VBES) is hull mounted near the center of rotation of the vessel.

The methods and systems described in this report are used to meet complete coverage and object detection coverage requirements and are in accordance with the *OCS Hydrographic Surveys Specifications and Deliverables Manual (3/2007)*, *Hydrographic Survey Directives*, and the *OCS Field Procedures Manual for Hydrographic Surveying (3/2007, v 2.1)*.

A.1. ECHOSOUNDING EQUIPMENT

ODOM ECHOTRAC CV VERTICAL-BEAM ECHOSOUNDER

The Odom Echotrac CV2 VBES is used as a single-frequency digital recording echosounder system with a digital recorder. The frequency settings range from 100 kHz to 1 MHz, though the normal operating frequency is 200 kHz. The manufacturer specifications of this sonar are included in Appendix I of this report.

The data is digitally recorded in meters as .bin files and Hypack files. The .bin files replace paper-trace records and can be viewed in Pydro Post Acquisition Tools. The Hypack files are converted to Caris HDCS data for processing. The Odom CV is primarily used simultaneously with the Klein 5000 SSS.

The ODOM Echotrac CV2 is inappropriate for sole use in situations requiring complete coverage or object detection coverage. However, combined with SSS data, the ODOM Echotrac CV can be used to meet NOAA specifications for complete and object detection coverage.

RESON SEABAT 8125 MULTIBEAM ECHOSOUNDER

The Reson SeaBat 8125 MBES is a single-frequency, digital-recording MBES with an operating frequency of 455 kHz. The RESON 8125 transducer consists of a flat transmitter array and solid cylindrical receiver array installed on a manually deployable arm off the starboard side of vessel s3004.



The Reson 8125 forms 240 beams each of which has a 0.5° across-track beam footprint for a maximum total swath width of 120° . Each beam has an along-track resolution of 1° . The ping rate is nominally 20-40 Hz, but may vary according to operating conditions. The Reson 8125 sonar is capable of bottom detection in depths from 3-120m. Specifications for this sonar are included in Appendix I of this report.

The Reson 8125 performs active beam steering to correct for sound speed at the transducer head using a surface sound speed sensor. This sensor is discussed in the Sound Speed Equipment section of this report¹. Real-time attitude data from the vessel's Applanix POS-MV attitude sensor is also input to the Reson 8125 to aid beam steering, though attitude correction is performed post-acquisition in Caris HIPS. The Applanix POS-MV attitude sensor is discussed in the Positioning and Orientation Equipment section of this report.

Reson 8125 data are acquired in meters using Isis XTF format. In addition to bathymetry, Reson "Snippets" and side scan data are also recorded in the XTF file. Reson "Snippets" and side scan data are not routinely used to generate charting products and are archived for second party scientific purposes such as sea bottom characterization, fish habit studies, or geological studies. Reson 8125 user parameters and surface sound speed are also recorded within the XTF file.

¹ An Odom Digibar is used aboard vessel s3004 for this purpose.

A.2. ACOUSTIC IMAGING EQUIPMENT

KLEIN 5000 HIGH-SPEED SIDE SCAN SONAR

The light weight Klein 5000 high-resolution side-scan sonar system is a digital-recording, beam-forming acoustic imagery device with an operating frequency of 455 kHz and vertical beam angle of 40°. The Klein 5000 system consists of a Klein towfish, a Transceiver/Processing Unit (TPU), and a computer for user interface.



The Klein 5000 system is distinct from other commercially-available SSS in that it forms five simultaneous, dynamically-focused receiver beams per transducer face to improve along-track resolution. The along-track resolution is approximately 30cm at the 100m range scale, even when acquiring data at speeds up to 10 knots. Across-track resolution is typically 7.5cm at the 100m range scale. The achievable 0.3m resolution meets the *OCS Hydrographic Surveys Specifications and Deliverables Manual* for object detection. Triton Isis is used to acquire data with the Klein 5000 SSS.

A.3. MANUAL SOUNDING EQUIPMENT

Vessel s3004 does not possess manual sounding equipment such as a sounding pole or a lead line.

A.4. POSITIONING AND ORIENTATION EQUIPMENT

Vessel s3004 uses an Applanix POS-MV 320 Version 4 inertial positioning and orientation system along with U.S. Coast Guard Differential GPS (DGPS) for a highly accurate blended position and orientation solution.

Vessel s3004 is equipped with a Trimble DSM132 DGPS receiver. The DSM132 includes a GPS receiver capable of receiving external RTCM correctors from a shore-based reference station. The system outputs position information once per second. Best expected position accuracy with the DSM132 system is less than one meter with 5 or more space vehicle vectors in the solution.

The POS/MV 320 includes dual GPS antennas, an inertial measurement unit (IMU), and data processor (PCS). The IMU measures linear and angular accelerations corresponding to the major motions of the vessel (heave, pitch, roll) and inputs this data to the PCS, where it is combined with a GPS position determined by carrier-phase differential

measurements to give the final position solution. Heading is calculated using a GPS-azimuthal measurement system (GAMS); two offset GPS receivers mounted on the cabin of the vessel input to the PCS.

The blended DGPS and inertial position/orientation solution has typical values of 0.02° true roll and pitch accuracy, 0.02° heading accuracy, 2m position accuracy, and 0.03 ms⁻¹ speed accuracy. These parameters are monitored in real time during acquisition using the POS/MV user interface software, PosView. These values meet the position accuracy standard for an IHO Order 1 survey.

Vessel s3004 is set up according to the “Precise Timing” method, a sonar acquisition configuration which applies a time stamp at the point of acquisition to all incoming sonar, attitude, and positioning data². The timing message is generated by the POS/MV and synchronizes the sonar system time with the POS/MV UTC time.

Although “Precise Timing” reduces the effect of time latency on MBES data, corrections for residual time latency biases must still be made via a patch test.

POS-MV True Heave files (.000) are also recorded during bathymetric data acquisition and applied in Caris HIPS/SIPS during post processing.

A.5. SOUND SPEED PROFILERS

SEA-BIRD SBE19+ CTD PROFILER

Vessel s3004 acquires water column sound speed data using a Sea-Bird Electronics SeaCat SBE19+ Conductivity-Temperature-Depth (CTD) profiler. Temperature is measured directly. Salinity is calculated from measured electrical conductivity. Depth is calculated from strain gauge pressure. The SBE19+ is capable of CTD profiling at depths from 0-350m. The SBE19+ is deployed by hand over the side of vessel s3004.

The CTD was returned to the manufacturer for calibration January 2007. Calibration documents are contained in Appendix IV of this report.

SEA SURFACE SOUND VELOCIMETERS

Vessel s3004 uses an Odom Digibar Pro for surface sound speed input to the Reson 8125. Unlike the CTD profiler, sea surface sound speed is calculated using two-way travel time. A pulse of known frequency is emitted and reflected off a surface. The two-way travel

² Further documentation on Precise Timing may be found in Appendix III of the 2007 Field Procedures Manual.

time is measured over the known distance between the transmitter and reflective surface, from which the sound speed is then calculated.

ODOM HYDROGRAPHIC SYSTEMS DIGIBAR PRO

The Digibar Pro is a real-time time-of-flight sea surface sound velocimeter. The manufacturer specified sound speed accuracy is 0.3 ms^{-1} . Aboard vessel s3004 the Digibar probe is mounted to top of the deployable sonar arm plate, below which the Reson 8125 is mounted. Data are sent in real time to the Reson 8P.



The Digibar Pro has not been calibrated since it was purchased in 2005.

B. SOFTWARE SYSTEMS

B.1 ACQUISITION SOFTWARE

HYPACK MAX

Hypack Max is a multi-function marine survey software package. Hypack Max is used for vessel navigation and for acquisition of VBES data and detached positions. Survey lines, vessel position with respect to lines, and various navigation parameters are displayed for the helmsman. Hypack also controls Isis data logging on the acquisition computer through the NOAA Delph string, allowing XTF files to be named by their Hypack line file name.

TRITON IMAGING *ISIS*

Isis is a Windows-based acquisition software package that provides real-time data display and sonar control. Isis is used to acquire Klein 5000 and Reson 8125 data in XTF format. The Isis setup is configurable for each type of sonar and allows the user to save the configuration files so that they are automatically launched during start-up. The same computer is used for SSS and MBES acquisition. Data acquisition is monitored real-time by a qualified sonar operator.

The primary user settings that are adjustable during SSS acquisition are the range scale and the resolution. Typically, the range scale and resolution are set prior to logging data and not changed again until the surveyed depth area changes.

The primary adjustable user settings during MBES acquisition are transmit power, range, gain, pulse length, ping rate, spreading, and absorption. Typically, power, range, and

gain are the only settings that are adjusted dynamically during the logging of a line file (power and gain sparingly). The pulse length, spreading, and absorption are set for the survey depth area and are rarely adjusted. The ping rate is set to its maximum because the Reson 8125 will only use the highest possible ping rate for the vessel speed and depth at any given time.

B.2. PROCESSING SOFTWARE

CARIS HIPS/SIPS v 6.1

Caris HIPS/SIPS (Hydrographic Information Processing System/ Side-scan Information Processing System) is used for processing, correcting, and analyzing all bathymetric, side scan, and phase-differencing bathymetric sonar data.

Caris HIPS is used for converting, correcting, cleaning, and analyzing gridded bathymetric data. Caris SIPS is used for converting and correcting side-scan sonar imagery and for contact selection and mosaic generation. Phase-differencing bathymetric sonar XTF files are processed in Caris as both bathymetric and side scan data files.

HSTP PYDRO

Pydro is a proprietary program developed and maintained by NOAA's Hydrographic Systems and Technology Program (HSTP), and is used primarily for feature management. Multibeam contacts (designated soundings), SSS contacts, and detached position are analyzed, grouped, and assigned S-57 classifications. Weighted grids (Caris surfaces) are imported into Pydro and accessed at survey scale for chart comparison. The Pydro Preliminary Smooth Sheet file (.pss) is delivered to the Atlantic Hydrographic Branch as part of the final submission package.

With the newest release of Pydro (v.7.x) the ability to process Tidal Constituents and Residual Interpolator (TCARI) tides has been implemented. If provided in the project instructions, the TCARI file for the area is loaded into Pydro along with the predicted, observed, or verified tide files for the corresponding stations. With this implementation, tides are no longer processed within Caris HIPS. Further discussion of TCARI is found in the Water Level Corrections section of this report.

HSTP VELOCWIN

HSTP Velocwin is a proprietary program for the processing of sound speed casts. This program uses Sea-Bird Electronics SeaTerm and SBE Data Processing software to convert hexadecimal SeaCat data into ASCII conductivity-temperature-depth data, and then converts the ASCII data into a depth-binned sound speed file. The resulting SVP files are applied in Caris HIPS during post-processing to correct for sound speed variation within the water column. These sound speed files are applied to the data in

Caris HIPS. Velocwin is also used to compare sound speed casts with its DQA function and to archive sound speed information for the National Oceanographic Data Center.

MAPINFO PROFESSIONAL 8.5

MapInfo Professional is the Geographic Information System (GIS) software package used by NRT7. MapInfo is used for sheet management, line planning, final data analysis and creating end-user products such as chartlets and survey plots.

C. ACQUISITION METHODS

The project instructions assigned to NRT7 call for Complete or Object Detection Coverage as defined in the FPM.

Where 200% SSS with VBES is used to comply with object detection requirements, two SSS line plans (100% coverage and 200% coverage) are created using the range scales appropriate for the survey area. Line spacing for the first 100% coverage is 120m at the 75 meter range scale and 160m at the 100 meter range scale. The line spacing for the second 100% coverage line plan is identical to the spacing for the first 100%, and the first line of the second 100% coverage is offset by half the line spacing. Vertical beam echo sounder data is acquired simultaneously with SSS data acquisition and used as the sole source of bathymetric data for charting purposes.

When the project instructions require complete coverage, MBES lines are planned at a spacing of two to three times the water depth and acquired at a speed of three to four knots. The design of the sonar pole mount is the speed limiting factor for all other modes of acquisition. The maximum survey speed is around eight knots; otherwise water wake from the pole is forced over the gunwale of the vessel. All lines are run parallel to each other except cross lines.

CROSS LINES

Cross lines are acquired in accordance with the *OCS Field Procedures Manual* as a confidence check of the survey data. Survey lines are planned such that ten percent of the total linear nautical miles are cross lines. Cross lines are planned perpendicular to main scheme lines when survey area allows. Cross lines are compared to the product navigation surface in Caris HIPS 6.1. The results of the Cross line QC test are submitted in Separate V of the Descriptive Report of each project.

D. CORRECTIONS TO ECHO SOUNDING AND QUALITY CONTROL

D.1. SOUND SPEED

SBE19+ CONDUCTIVITY, TEMPERATURE AND DEPTH (CTD) PROFILER

Sound speed profiles acquired with the Sea-Bird Electronics SeaCat SBE19+ CTD profiler are processed using the HSTP program Velocwin, which generates sound speed profile (SVP) files that are used to correct bathymetric HDCS data in Caris HIPS. Sound speed correctors are applied to MBES and VBES soundings during post processing.

The interval at which CTD casts are conducted depends on the data acquisition type, survey area and prevailing conditions. At a minimum, one CTD cast per week for VBES sound speed correction and one CTD cast every three to four hours for MBES acquisition is conducted. Casts are conducted more frequently when changing survey areas, or when survey conditions such as weather, tide, or current change sufficiently.

D.2. WATER LEVEL CORRECTORS

Soundings are initially reduced to Mean Lower-Low Water (MLLW) using predicted tides or preliminary (observed) zoned water level data. Data are obtained from the local, primary tide gauges through the Center for Operational Oceanographic Products and Services (CO-OPS) website (<http://tidesandcurrents.noaa.gov/olddata>). Predicted or observed water level files are converted to Caris tide files (.tid) and applied to all sounding data using either discrete tide zoning in Caris HIPS (.zdf files) or the TCARI module in Pydro if provided by CO-OPS.

After data acquisition is complete, a request for final, approved water levels is submitted to CO-OPS. Once final approved water levels are received, sounding data are re-corrected to MLLW using either the verified zones or the verified TCARI files.

D.3. TCARI

Starting with the 2007 field season, some projects require the use of the TCARI model for water level correction. Tidal Constituents and Residual Interpolator is a gridded interpolation algorithm that assigns appropriate water level time and phase offsets to echosounder data at each grid node.

If the use of TCARI files for water level correction is directed by the Project Instructions, then the Pydro TCARI tools found in Pydro 7.xx , are used to overwrite tide file in the HDCS line folder.

D.4. HEAVE, PITCH, ROLL AND HEADING, INCLUDING BIASES AND NAVIGATION TIMING ERRORS

Heave, pitch, roll, and timing bias values for vessel s3004 are determined during a patch test after a system is newly mounted on the sonar arm. Vessel offsets, dynamic draft correctors, and system bias values are entered in the sonar's Caris Hydrographic Vessel Files (.hvf) and applied during Caris' merge process.

D.5. VESSEL OFFSETS AND DYNAMIC DRAFT CORRECTORS

The vessel offsets were measured with a total station by the NOAA National Geodetic Service in Norfolk, VA, in the fall of 2005. The offsets are found in Appendix III of this report, and are also entered in the HVFs submitted with each survey. The dynamic draft values used for s3004 are those measured on s3002 (NRT5), an identical vessel. The dynamic draft values are entered in the HVFs submitted with each survey.

E. DATA PROCESSING AND QUALITY CONTROL

E.1. BATHYMETRY

Raw bathymetry data (XTF and Hypack) are converted into Caris HDCS data format upon completion of daily acquisition. Conversion parameters vary for each data format, and are stored in the LogFile of each HDCS processed line folder. After conversion, data are corrected with true heave, tides, and sound speed and then merged. Following merge, Total Propagated Error (TPE) is calculated.

For further explanation of TPE calculations refer to Section 4.2.1.1 of the 2007 *OCS Field Procedures Manual* (v. 2.2, March 2007).

VERTICAL BEAM BATHYMETRY

When VBES is the sole source of bathymetry (e.g. 200% SSS + VBES survey), VBES is converted to Caris HDCS and processed as described in the previous paragraph. The data is then examined and cleaned in Caris Singlebeam Editor. Digital records (.bin files) are used to provide extra information during data cleaning. The .bin files are viewed in Pydro Post Acquisition Tools. After the data has been processed and cleaned, an uncertainty-weighted BASE Surface is computed (usually at a resolution of five meters).

MULTIBEAM BATHYMETRY

Depending on acquisition type, MBES bathymetry is analyzed using Caris BASE surface layers. Caris BASE surfaces are described in detail in the 2007 *OCS Field Procedures Manual* and the *Caris HIPS/SIPS 6.1 Users Manual*.

When the primary source of bathymetry for a survey area is a combination of VBES and MBES, a collection of finalized CUBE surfaces is generated as the depth product of the survey. The data is examined and cleaned as necessary to reject gross fliers and to identify systematic data errors. Systematic errors are corrected or removed from the project, documentation of which is found in the survey processing notes or descriptive report. The surface names contain the resolution at which they were created, which is based on depth and data density.

When Complete or Object Detection MBES is the primary source of bathymetry, data are processed using CUBE. After computation of TPE, MBES lines are either used to create a new surface or are added to an existing surface. The resulting layers are analyzed by the data processor to identify fliers and/or systematic errors, and to identify significant bottom features. Fliers are rejected by the data processor in Caris Subset Editor (multi-line spatial view) or Caris Swath Editor (single-line time-series view). Systematic errors are identified and documented by the data processor. Least depths of navigationally significant features are flagged as “designated soundings,” which both identifies the object as a navigationally significant object for import into Pydro and forces the depth of the grid to match the least depth of the feature.

After data editing is complete, grids are finalized and combined for delivery to the Atlantic Hydrographic Branch. Surface resolution depends on depth and survey type (see *OCS Hydrographic Specifications and Deliverables Manual* for further information), and is specified in the name of the surface.

E.2. IMAGERY

After acquisition, SSS data are converted from XTF format to Caris HDCS format. Fish height, vessel heading (gyro), and vessel navigation records are then reviewed and corrected and recalculated. Data are then slant-range corrected to 0.1m with beam pattern correction. The slant-range corrected SSS imagery data are closely examined for contacts. Imaged objects are evaluated for significance based upon apparent shadow length and appearance. Contacts are selected³ and saved to a contact file within the respective Caris HDCS line file and inserted into Pydro for feature management.

Two mosaics are created after SSS data have been processed; one of the first 100% of coverage and one of the second 100% of coverage (200%). If any deficiencies in the SSS coverage are found, a holiday line file is created from the mosaics, and additional lines of SSS are acquired.

E.3. BATHYMETRY ANALYSIS AND FEATURE CLASSIFICATION

Following data cleaning in Caris HIPS and SIPS, the following items are inserted into Pydro and saved in a Preliminary Smooth Sheet (PSS) file: finalized weighted

³ Contact selection includes measuring apparent height, selecting contact position, and creating a contact snapshot (*.tif) image.

bathymetry grids, SSS contacts, MBES designated soundings, detached positions (DPs), Geographic Positions (GP), bottom samples (Hypack DPs), and AWOIS items. The Pydro .pss is used for survey analysis and feature management.

Images of contacts exported from Caris are displayed in the Image Notebook Editor in Pydro. Contacts are arranged by day and line and can be selected in the data “Tree” window. Information concerning a specific contact is reviewed in the Editor Notebook Window in Pydro. This information includes position, surrounding depths, contact cross references, and charting recommendations.

Each contact is reviewed, and information flags are set accordingly as described in the Pydro Data Flagging Decision Tree (Figure 4-22 in the *OCS Field Procedures Manual*). Contacts appearing significant⁴ are further investigated with MBES or VBES.

Multiple representations of one distinct feature (e.g. contacts from two or more SSS lines on a wreck) may be correlated together. For a group of correlated features, one representation is selected as the primary contact, and all others are selected as secondary contacts with respect to the primary contact.

After a feature is fully classified, primary features are flagged as “Resolved.” If a primary feature is flagged “Resolved,” then the secondary features correlated to that primary feature are automatically flagged “Resolved” and are given the same full classification as the primary feature.

After all items within the PSS have been resolved, three reports are generated for submission to the Atlantic Hydrographic Branch: Feature Report, AWOIS Report, and DTON report⁵.

E.4. SURVEY DELIVERABLES AND ANCILLARY PRODUCT GENERATION

All data are submitted digitally in close-keeping with section 5.1.2.2 the *OCS Hydrographic Field Procedures Manual*; including raw and processed sonar data, ancillary correction data (tides, sound speed, true heave, hydrographic vessel files, etc), supporting products (Pydro PSS files, Caris sessions and field sheets); and all supporting reports and documentation.

The final bathymetric deliverable is a collection of gridded surfaces. Side scan sonar mosaics are also submitted as evidence of appropriate imagery coverage. These mosaics are also used to identify contacts, as well as general bottom type. Bathymetric surfaces and SSS mosaics are submitted in their respective Caris field sheets. In addition, the

⁴ Significant features are defined by the Hydrographic Survey Specifications and Deliverables as an object rising more than one meter above the seafloor in water depths of 0-20 meters, and an object rising 10% of depth above the seafloor in water depths greater than 20 meters.

⁵ Danger to Navigation (DTON) reports are generated immediately after discovery and are so submitted to the Marine Chart Division of the NOAA Office of Coast Survey. Multiple DTON reports during the course of a survey are possible. If no dangers are found during the course of a survey, no report is generated.

Pydro Preliminary Smooth Sheet (PSS) file is submitted as the record of survey feature management.

E. APPROVAL

As Team Leader, I have ensured that standard field surveying and processing procedures were utilized in accordance with the *NOS Hydrographic Manual, Fourth Edition; Field Procedures Manual*, and the *NOS Hydrographic Surveys Specifications and Deliverables*.

I acknowledge that all of the information contained in this report is complete and accurate to the best of my knowledge.

LT(jg) Briana Welton, NOAA
Team Leader, NRT7

Appendix I

Hydrographic Hardware Inventory

Field Unit: SPOT (s3004)

Effective Date: MARCH 2007

Updated Through: MARCH 2007

SONAR & SOUNDING EQUIPMENT

Equipment Type	Manufacturer	Model	Serial Number	Firmware and/or Software Version	Version Install Date	Date of last Calibration	Date of last Service
Multibeam Echosounder	Reson	8125	31546	unknown	unknown	unknown	unknown
Side Scan Sonar	Klein	System 5000	Towfish 317, TPU 157	unknown	unknown	new	new
Interferometric Sonar	Benthos	C3D	40364	unknown	unknown	new	new

POSITIONING & ATTITUDE EQUIPMENT

Equipment Type	Manufacturer	Model	Serial Number	Firmware and/or Software Version	Version Install Date	Date of last Calibration	Date of last Service
GPS Aided Inertial Navigation	Applanix	POS/MV 320 V4	2233	3.3.2.2	Nov-06	3/22/2007	none (new)
DGPS Reciever	Trimble	DSM132	224090080				
Attitude Sensor	Applanix	320	2233			3/22/2007	

SOUND SPEED MEASUREMENT EQUIPMENT

Equipment Type	Manufacturer	Model	Serial Number	Firmware and/or Software Version	Version Install Date	Date of last Calibration	Date of last Service
Sound Speed Profiler	Sea-Bird	SeaCat Plus Profiler	19P36399-4634			Mar-05	Mar-05
Surface Sound Velocimeter	Odom	Digibar Pro	98350			new	n/a

TIDES & LEVELING EQUIPMENT

Equipment Type	Manufacturer	Model	Serial Number	Firmware and/or Software Version	Version Install Date	Date of last Calibration	Date of last Service
none							

HORIZONTAL AND VERTICAL CONTROL EQUIPMENT

Equipment Type	Manufacturer	Model	Serial Number	Firmware and/or Software Version	Version Install Date	Date of last Calibration	Date of last Service
GPS Backpack	Trimble	TSCe	31462	Terrasync Ver???? Pathfinder????	7-Jan	none	none

OTHER EQUIPMENT

Equipment Type	Manufacturer	Model	Serial Number	Firmware and/or Software Version	Version Install Date	Date of last Calibration	Date of last Service

--

Additional Information

240 Beams 1° x 0.5° Resolution

--

--

Additional Information

--

--

--

--

Roll/Pitch Accuracy: 0.05° Heave Accuracy: the greater of 5cm or 5% for periods of 20s or less

Additional Information

--

--

--

--

--

Additional Information
Additional Information
Additional Information

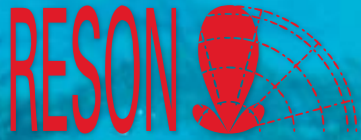

SeaBat 8125

ULTRA HIGH RESOLUTION FOCUSED
MULTIBEAM ECHOSOUNDER SYSTEM



SeaBat 8125

- **Focused 0.5° beams**
- **240 beams**
- **2.5cm near field resolution**
- **6mm depth resolution**
- **120° swath**

The SeaBat 8125 is the first wide-sector, wide-band, focused multibeam sonar ever to be deployed. Utilizing 240 dynamically focused receive beams, the system measures a 120° swath across the seafloor, detects the bottom, and delivers the measured ranges at a depth resolution of 6mm. The backscatter intensity image is displayed in real time on the sonar display.

The 8125 can be controlled through its native graphical user interface, or through an external control data collection and navigation software package.

The system can be mounted on a survey vessel or deployed on an ROV at depths down to 1500m. The high-speed data uplink is carried on a standard SeaBat copper cable for surface installation. A fiber-optical interface is available for ROV deployment.





SeaBat 8125

ULTRA HIGH RESOLUTION FOCUSED MULTIBEAM ECHOSOUNDER SYSTEM

SYSTEM PERFORMANCE

Frequency:	455kHz
Depth Resolution:	6mm
Swath Coverage:	120°
Max Range:	120m
Number of Beams:	240
Along-Track Beamwidth:	1°
Across-Track Beamwidth:	0.5° (at nadir)
Accuracy:	<ul style="list-style-type: none"> • IHO Special Order • U.S. Army Corps of Engineers Special Order
Operational Speed:	Up to 12 knots
Max. Update Rate:	40
Transducer Depth Rating:	600m (Standard) 1500m (Optional)

INTERFACE

System Supply:	115V/230V 50/60Hz, 350W max
Video Display:	SVGA, 800 x 600, 72Hz
System Control:	Trackball
Data Output:	10MB Ethernet or serial RS232C
Data Uplink:	High-speed digital coax with fiber-optic option
Sonar Head Supply:	24VDC, 5.6A Peak, 2A Average (May be supplied from sonar processor)
Temperature:	Operating: 0° to +40°C Storage: -30° to +55°C

MECHANICAL INTERFACE

Power Requirements:	24VDC, 5.6A Peak, 2A Average (May be supplied from sonar processor)
Operating Depth:	600m/1500m
Dimensions:	266 x 320mm (W / D) excluding projector
Temperature:	Operating: -5° to +40°C Storage: -30° to +55°C
Weight (aluminum):	Dry: 26.8kg (59lbs.) Wet: 4.8kg (10.6lbs.)
Weight (titanium):	Dry: 40kg (88lbs.) Wet: 18kg (39.6lbs.)

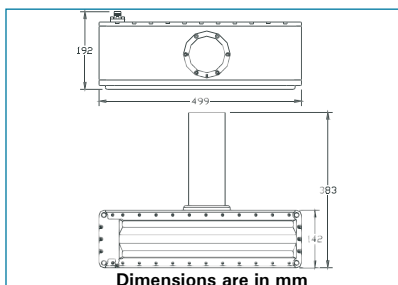
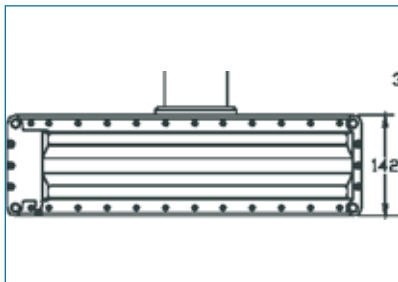
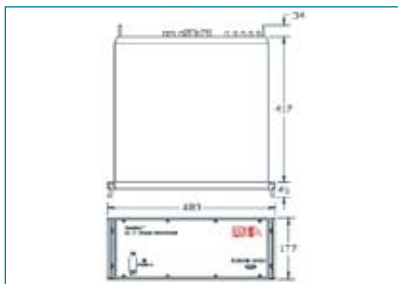

RESON reserves the right to change specifications without notice. © 2006 RESON A/S
For Acoustical Measurement Accuracy please refer to www.reson.com or contact sales.

RESON A/S
Denmark
Tel: +45 4738 0022
E-mail: reson@reson.dk

RESON Inc.
USA
Tel: +1 805 964-6260
E-mail: sales@reson.com

RESON OFFSHORE LTD.
Scotland, U.K.
Tel: +44 1224 709 900
E-mail: sales@reson.co.uk

RESON GmbH
Germany
Tel: +49 431 720 7180
E-mail: reson@reson-gmbh.de

RESON B.V.
The Netherlands
Tel: +31 (0)10 245 1500
E-mail: info@reson.nl

RESON Mediterranean SRL
Italy
Tel: +39-051-572-643
E-mail: info@reson.it

RESON-Telenav Electronics Pte. Ltd.
Singapore
Tel: +65-6-872-0836
E-mail: sales@reson.sg

RESON SA (PTY) LTD.
South Africa
Tel: +27 21 701-1720
E-mail: reson@reson.co.za



communications
Klein Associates, Inc.

KLEIN ASSOCIATES INC.

HOME

Multi-beam Sonar System 5500 Specifications

Towfish

Number of beams:	10 (5 per side)
Frequency:	455 kHz
Pulse length:	50 to 200usec user selectable
Resolution (along track):	20 cm to 75 m, increasing to 36 cm at 150 m max. range
Resolution (across track):	Deturmined by selected pulse length.
Operating Speed Envelope:	2 to 10 knots @150 m Sonar Range
Sonar Digitization:	12 bits per channel
Maximum Operating Range:	150 m (300 m Swath)
Array Length:	120 cm (47.2 in)
Body length:	194 centimeters (76.4 in)
Body Diameter:	15.2 centimeters (6 in.)
Weight in air :	70 kg (155 lbs.) nominal
Heading sensor:	Standard Equipment
Pressure sensor:	Standard Equipment
Pitch and roll sensor:	Standard Equipment
Altimeter sensor:	Standard Equipment

Towfish Options

Yaw Rate & High Resolution Roll Sensors:	Optional
Temperature Sensor:	Optional
Responder:	Optional

Tranceiver Processor Unit

Width:	19 in. rack mount
Height:	13.2 cm (5.2 in)
Depth:	54.6 cm (21.5 in)
Weight:	12.7 kg (28 lbs.)
Voltage:	115 / 240 VAC 50 / 60 Hz
Power:	120 watts
Navigation Input:	NEMA 0183

Data Output:	100 Base-Tx Ethernet LAN
PC Display / Control Unit:	Klein Ruggedized or Customer Supplied PC
Display Software:	SonarPro Software suite

Towcable

Type:	Coaxial or Fiber-optic double armored steel. Contact Klein for specifications
--------------	--

C3D-LPM

SONAR IMAGING SYSTEM

Lightweight pole mount for small vessel, shallow water applications



C3D-LPM Transceiver

The C3D-LPM transceiver houses the DSP, power supply and all the circuitry necessary for signal processing. The transceiver module interfaces to a standard PC (either supplied by Teledyne Benthos or customer supplied) via Ethernet. The DSP runs on 110/220 VAC power auto sensing.



C3D-PC All-in-One Computer

The C3D-PC is an all-in-one computer installed with third party acquisition software to display and store C3D data. The small footprint allows for easy installation on most small vessels. The PC operates on 110/220 VAC auto sensing.

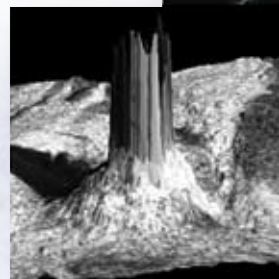
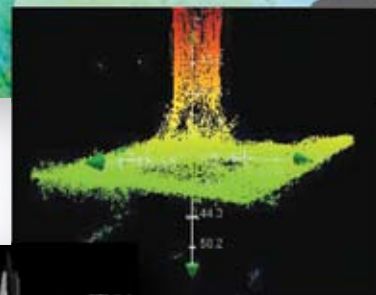
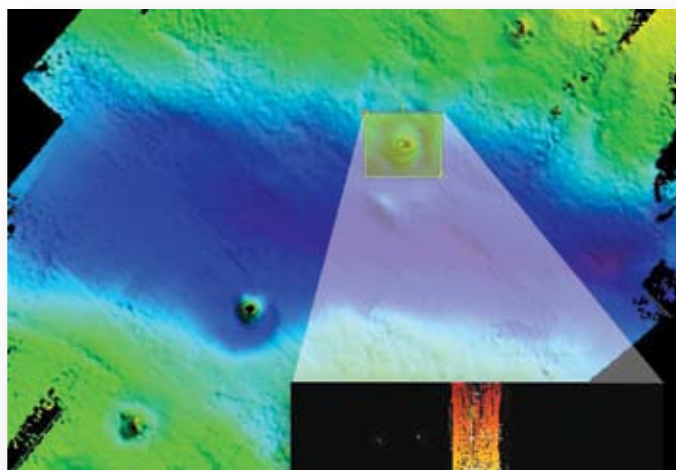

C3D-LPM Sonar Imaging System



System Specifications

C3D System

Sonar Frequency:	200 kHz
Side Scan Range:	25 to 300 meters per side
Bathymetric Range:	10 to 12 times water depth
Resolution (across track)	
Side Scan Sonar:	4.5 cm
Bathymetry:	5.5 cm
Beam Width:	1 degree (one-way)
Pulse Length:	25 usec to 1 msec (depending on range)
Repetition Rate:	Up to 30 pings/sec
Depression Angle:	20, 30, 40 degrees
Transmit Source Level:	Max. 224dB re: 1uPa@1M

C3D-LPM

Construction:	Stainless steel imbedded in glass filled polyurethane
Length:	99.3 cm (39.1 inches)
Diameter:	17.3 cm (6.8 inches)
Weight (in air):	20.4 kg (45 lbs)

C3D-LPM Transceiver

Topside Interface	
Power Supply:	Input 110/220 VAC auto sensing
Network interface:	Ethernet
Dimensions:	2U Rack mount 48.3 cm (19 inches)
Weight:	9.5 kg (21 lbs)
Transducer Cables:	10 meters standard

C3D-PC

Operating System:	Windows XP
Processor:	Pentium processor
Storage:	Large capacity hard drive, writable CD/DVD
Network Interface:	100base T Ethernet (compatible with ADSL high-speed communications interface)
Serial:	RS232
Display Monitor:	17" flat panel (built into processor)

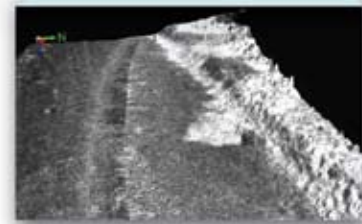
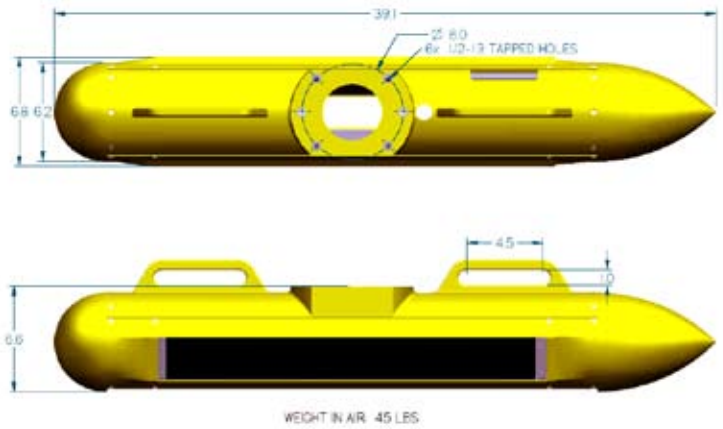

**TELEDYNE
BENTHOS**

A Teledyne Technologies Company

www.benthos.com

Teledyne Benthos

49 Edgerton Drive, North Falmouth, MA 02556 USA

Tel 508-563-1000 • Fax 508-563-6444 • E-mail: benthos@teledyne.com

Specifications subject to change without notice. 3/2007. ©2007 TELEDYNE BENTHOS, Inc.
Other products and company names mentioned herein may be trademarks and/or registered trademarks.

ODOM ECHOTRAC CV™



odom
HYDROGRAPHIC SYSTEMS

HYDROGRAPHIC ECHO SOUNDER

*DUAL FREQUENCY WITH OPTIONAL
THIRD CHANNEL*

- Modular “black box” configuration includes rack mount option, Ethernet LAN interface, frequency agile configurable transceivers, standard serial interfaces for data acquisition systems, motion sensors and DGPS receivers.
- Options include modular sunlight viewable color LCD chart with internal data storage, high-resolution thermal paper recorder or display and control on your PC!

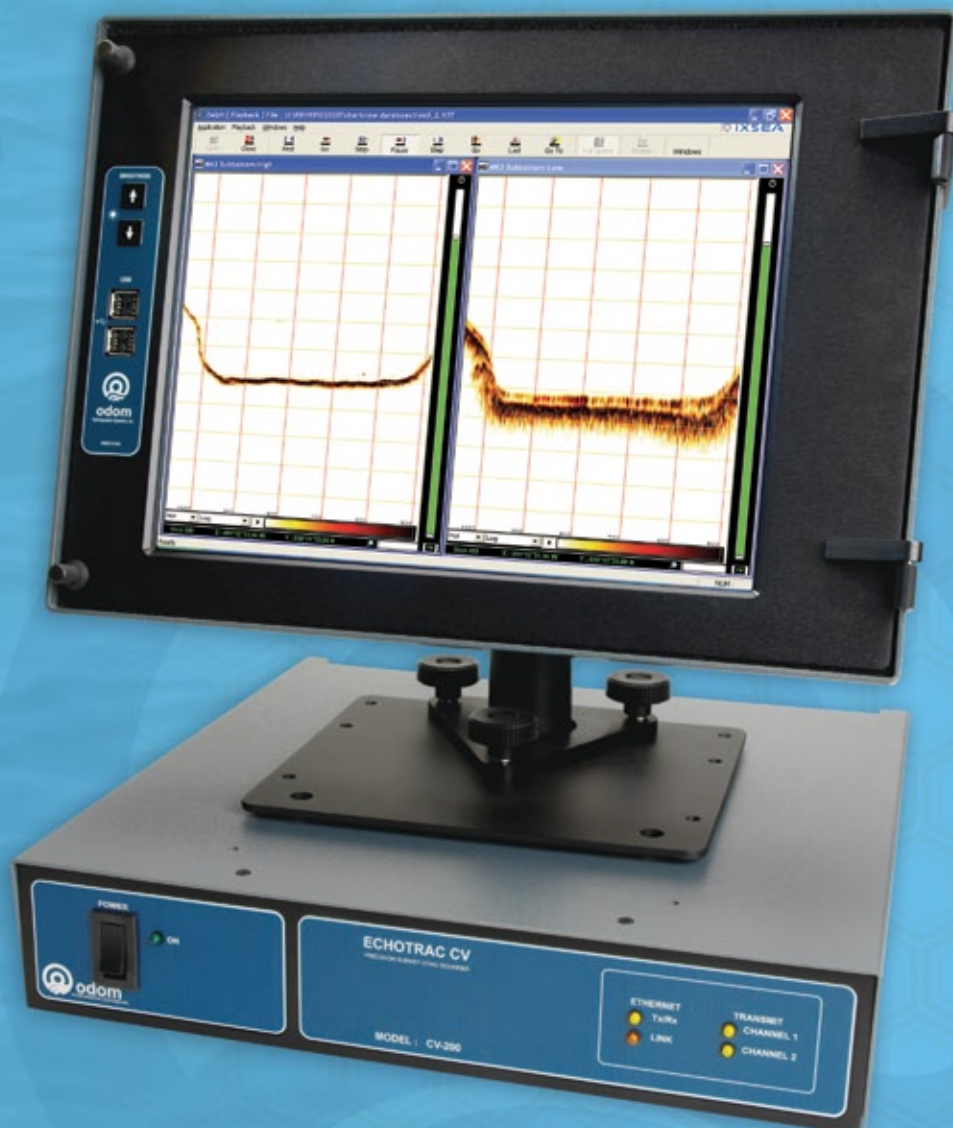

ODOM ECHOTRAC CV™

You asked for more convenience and superior efficiency in your hydrographic survey tools. Odom answered.

Say hello to **Echotrac CV™**! With this new echo sounder, Odom delivers the perfect union of flexibility and technology, viewed

through a user-friendly networked Windows interface. Alongside the advanced features and options that made the **Echotrac™ MKIII** a stand-out product, the CV brings users to the next level by providing an optional third acoustic channel. Whether it's a side scan, bathymetric or a shallow subbottom investigation, the CV has the flexibility to handle the task!

Buy Odom – invest in your peace of mind.

S P E C I F I C A T I O N S

Frequency

- High band: 100 kHz – 1 MHz
- Low band: 10 kHz – 50 kHz
- Optional very low band: 3 kHz to 24 kHz

Output Power

- High: 100 kHz – 1 kW RMS max 200 kHz – 900 W RMS max, 750 kHz – 300 W RMS max
- Low: 12 kHz – 2 kW RMS max, 50 kHz – 1.5 kW RMS max
- Very low: 3 kHz 4000 W RMS max (transducer impedance dependant)

Input Power

- 110 or 220 V AC – 24 V DC 50 watts

Resolution

- 0.01 m/0.1 ft

Accuracy

- 0.01 m/0.10 ft +/- 0.1% of depth @ 200 kHz
- 0.10 m/0.30 ft +/- 0.1% of depth @ 33 kHz
- 0.18 m/0.60 ft +/- 0.1% of depth @ 12 kHz

Depth Range

- 0.2 – 200 m / 0.5 – 600 ft @ 200 kHz
- 0.5 – 1600 m / 1.5 – 5000 ft @ 33 kHz
- 1.0 – 6000 m / 3.0 – 20,000 ft @ 12 kHz

Phasing

- Automatic scale change, 10%, 20%, 30% overlap or manual

Printer

- High resolution 8 dot/mm (203 dpi), 16 gray shades
- 216 mm (8.5 in) wide thermal paper or film
- External ON/OFF switch
- Paper advance control

Paper Speed

- 1 cm/min (0.5 in/min) to 22 cm/min (8.5 in/min), Auto = one dot row advance for each Ping

LCD Display

- 15 in TFT screen
- High-Bright (500 NIT)
- Internal data storage in XTF format on 40 GB hard disk
- Data transfer via Ethernet interface or USB flash drive

Sound Velocity

- 1370 – 1700 m/s
- Resolution 1 m/s

Transducer Draft Setting

- 0 – 15 m (0 – 50 ft)

Depth Display

- On control PC and remote LCD display

Clock

- Internal battery backed time, elapsed time and date clock

Annotation

- Internal – date, time, GPS position
- External – from RS232 or ethernet

Interfaces

- 4 x RS232 or 3 x RS232 and 1 x RS422
- Inputs from external computer, motion sensor, sound velocity
- Outputs to external computer, remote display
- Outputs with LCD chart – VGA video out
- Ethernet interface
- Heave – TSS1 or sounder sentence

Blanking

- 0 to full scale

Installation

- Desktop or optional rack mount and bulkhead mount

Software

- Echotrac control supplied
- ChartView supplied with LCD configuration

Help

- The function of each parameter and it's minimum and maximum values can be printed on the paper chart. Also, a record of all parameter settings can be printed on the chart.

Environmental Operating Temperature

- 0°–50° C, 5–90% relative humidity, non-condensing

Dimensions

- 9 mm (3.5 in) H x 45 mm (1.7 in) W x 300 mm (12.8 in) D

Weight

- 15.9 kg (35 lbs)

Options

- Third acoustic channel (multiple configurations)
- Remote display
- Side scan transducer – single or dual channel side looking 200 kHz or 340 kHz for search and reconnaissance
- Built-in DGPS
- Subbottom Array (3.5 kHz 4 element array with stainless steel mounting frame typical)



odom
HYDROGRAPHIC SYSTEMS

1450 Seaboard Avenue
Baton Rouge, Louisiana 70810-6261 USA
E-mail: email@odomhydrographic.com
www.odomhydrographic.com

SEACAT Profiler

SBE 19plus

The SBE 19plus is the next generation *Personal CTD*, bringing numerous improvements in accuracy, resolution (in fresh as well as salt water), reliability, and ease-of-use to the wide range of research, monitoring, and engineering applications pioneered by its legendary SEACAT predecessor. The 19plus samples faster (4 Hz vs 2), is more accurate (0.005 vs 0.01 in T, 0.0005 vs 0.001 in C, and 0.1% vs 0.25% — with *seven* times the resolution — in D), and has more memory (8 Mbyte vs 1). There is more power for auxiliary sensors (500 ma vs 50), and they are acquired at higher resolution (14 bit vs 12). Cabling is simpler and more reliable because there are four differential auxiliary inputs on two separate connectors, and a dedicated connector for the pump. All exposed metal parts are titanium, instead of aluminum, for long life and minimum maintenance.

The 19plus can be operated without a computer from even the smallest boat, with data recorded in non-volatile FLASH memory and processed later on your PC. Simultaneous with recording, real-time data can be transmitted over single-core, armored cable directly to your PC's serial port (maximum transmission distance dependent on number of auxiliary sensors, baud rate, and cable properties). The 19plus' faster sampling and pump-controlled TC-ducted flow configuration significantly reduces salinity spiking caused by ship heave, and allows slower descent rates for improved resolution of water column features. Auxiliary sensors for dissolved oxygen, pH, turbidity, fluorescence, and PAR can be added. For moored deployments, the 19plus can be set to *time-series* mode using software commands. External power and two-way real-time communication over 10,000 meters of cable can be provided with the SBE 36 CTD Deck Unit and Power and Data Interface Module (PDIM).

The 19plus uses the same temperature and conductivity sensors proven in 5000 SEACAT and MicroCAT instruments, and a superior new micro-machined silicon strain gauge pressure sensor developed by Druck, Inc. Improvements in design, materials, and signal acquisition techniques yield a low-cost instrument with superior performance that is also easy to use. Calibration coefficients, obtained in our computer-controlled high-accuracy calibration baths, are stored in EEPROM memory. They permit data output in ASCII engineering units (degrees C, Siemens/m, decibars, Salinity [PSU], sound velocity [m/sec], etc.).

Accuracy, convenience, portability, software, and support: compelling reasons why the 19plus is today's best low-cost CTD.

CONFIGURATION AND OPTIONS

A standard SBE 19plus is supplied with:

- Plastic housing for depths to 600 meters
- Strain-gauge pressure sensor
- 8 Mbyte FLASH RAM memory
- 9 D-size alkaline batteries
- Impulse glass-reinforced epoxy bulkhead connectors: 4-pin I/O, 2-pin pump, and two 6-pin (two differential auxiliary A/D inputs each)
- SBE 5M miniature pump with plastic housing for depths to 600 meters, and T-C Duct

Options include:

- Titanium housing for depths to 7000 meters
- SBE 5M miniature pump with titanium housing in place of plastic housing
- SBE 5P (plastic) or 5T (titanium) pump in place of SBE 5M for use with dissolved oxygen and/or other pumped sensors
- Bulkhead connector for use with PAR sensor
- Sensors for oxygen, pH (for integration in Profiling mode only), fluorescence, light (PAR), light transmission, and turbidity
- Stainless steel cage
- MCBH *Micro* connectors in place of glass-reinforced epoxy connectors
- Nickel Metal Hydride (NiMH) or Nickel-Cadmium (Ni-Cad) batteries and charger
- Moored mode conversion kit with anti-foulant device fittings

SOFTWARE

The SBE 19plus is supplied with a powerful Windows 2000/XP software package, SEASOFT[®]-Win32, which includes:

- SEATERM[®] — communication and data retrieval
- SEASAVE[™] — real-time data acquisition and display
- SBE Data Processing[®] — filtering, aligning, averaging, and plotting of CTD and auxiliary sensor data and derived variables

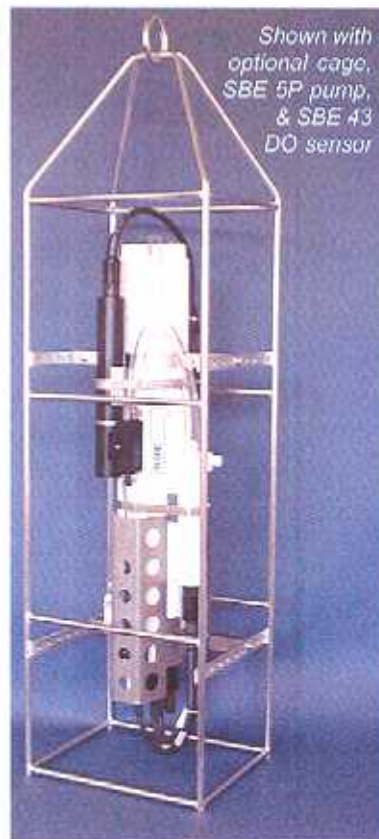

Sea-Bird Electronics, Inc.

1808 136th Place NE, Bellevue, Washington 98005 USA

Website: <http://www.seabird.com>

E-mail: seabird@seabird.com

Telephone: (425) 843-9886

Fax: (425) 643-9954

SEACAT Profiler

SBE 19plus



Dimensions
in millimeters
(inches)

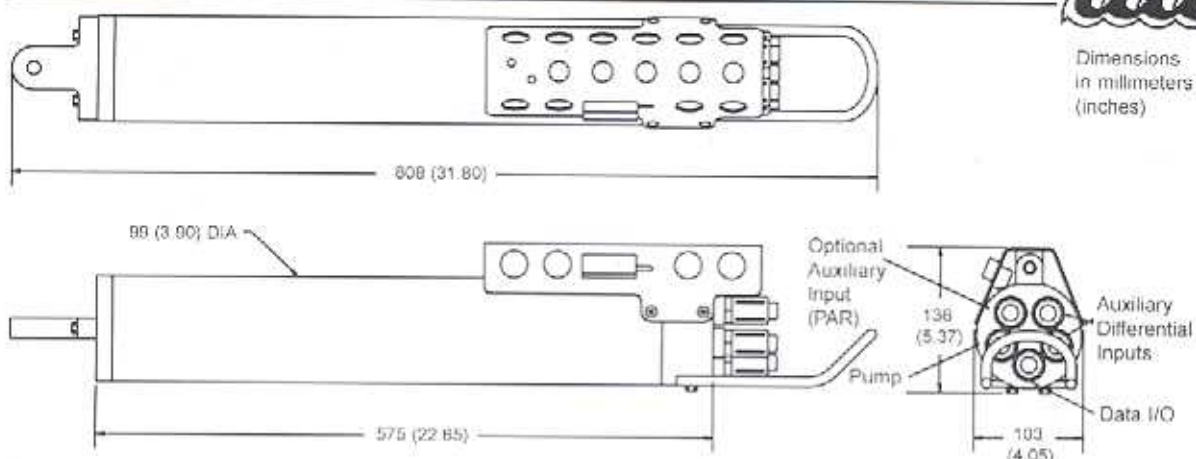

SPECIFICATIONS

	Measurement Range	Initial Accuracy	Typical Stability (per month)	Resolution
Conductivity (S/m)	0 to 9	0.0005	0.0003	0.00005 (most oceanic waters; resolves 0.4 ppm in salinity) 0.00007 S/m (high salinity waters; resolves 0.4 ppm in salinity) 0.00001 S/m (fresh waters; resolves 0.1 ppm in salinity)
Temperature (°C)	-5 to +35	0.005	0.0002	0.0001
Pressure	0 to 20/100/350/600/ 1000/2000/3500/ 7000 meters	0.1% of full scale range	0.004% of full scale range	0.002% of full scale range

Memory 8 Mbyte non-volatile FLASH memory

Data Storage

Recorded Parameter	Bytes/Sample
T + C	6
pressure	5
each external voltage	2

Real-Time Clock 32,768 Hz TCXO accurate to ±1 minute/year

Internal Batteries 9 alkaline D-cells (Duracell MN1300, LR20) provide 60 hours profiling; optional 9-cell NiMH battery pack provides 40 hours profiling per charge; optional 9-cell Ni-Cad battery pack provides 24 hours profiling per charge

External Power Supply 9 - 28 VDC; consult factory for required current

Power Requirements

Sampling	65 mA	
Pump	SBE 5M: 100 mA	Optional SBE 5T or 5P: 150 mA
Communications	60 mA	
Quiescent	30 µA	

Auxiliary Voltage Sensors

Auxiliary power out	up to 500 mA at 10.5 - 11 VDC
A/D resolution	14 bits
Input range	0 - 5 VDC

Housing Materials, Depth Rating, Weight in air*, Weight in water*

Acetal Copolymer Plastic housing, 600 meter (1950 feet), 7.3 kg (16 lbs), 2.3 kg (5 lbs)
3Al-2.5V Titanium housing, 7000 meter (22,900 feet), 13.7 kg (30 lbs), 8.6 kg (19 lbs)
*Weights listed are without pump, pump adds (in air) 0.3 to 0.7 kg (0.6 to 1.5 lbs), depending on pump model selected. See pump brochures for details.

Optional Cage

1016 mm x 241 mm x 279 mm (40 in. x 9.5 in. x 11 in.), 6.3 kg (14 lbs)

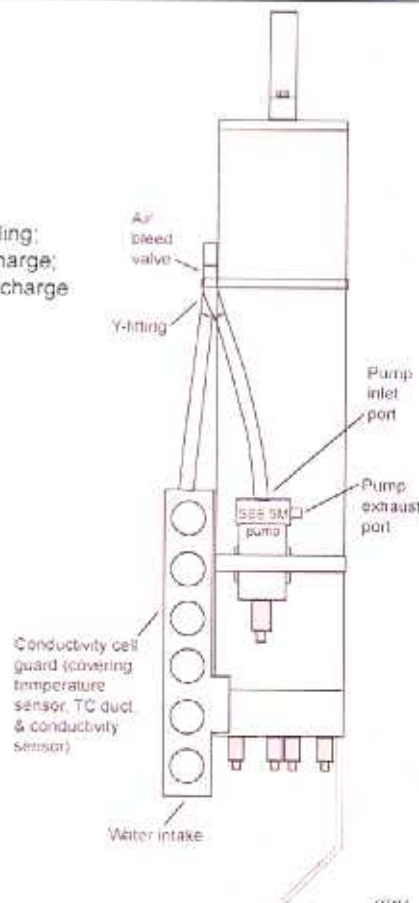

Sea-Bird Electronics, Inc.

1808 136th Place NE, Bellevue, Washington 98005 USA
Website: <http://www.seabird.com>

E-mail: seabird@seabird.com

Telephone: (425) 643-9866

Fax: (425) 643-9954

ODOM
DIGIBAR PROTM
FOR SEAFLOOR OR RIVERBED SURVEYS



odom
HYDROGRAPHIC SYSTEMS

MODEL DB1200 –
PROFILING SOUND
VELOCIMETER



ODOM DIGIBAR PRO™

FOR SEAFLOOR OR RIVERBED SURVEYS

The Digibar Pro™ is the most cost-efficient and accurate means of determining water column sound velocities. It quickly calibrates acoustic systems regardless of sea state or current, and is **faster** and **safer** than the traditional bar check

method. Digibar Pro™ uses “sing-around” technology, which automatically compensates for all factors influencing sound velocity, including salinity, depth and temperature.

Buy Odom – invest in your peace of mind.

GENERAL SPECIFICATIONS

PROBE

Sing-Around Frequency

- 11 kHz

Communications

- RS485, 19.2 kBaud

Temperature Range

- 39° F - 104° (4° C – 40° C) Typical

Sample Rate

- 10 Hz

Depth Sensor Accuracy

- 1.0 ft (31.0 cm)

Dimensions

- 14.7 l x 2.0 d in (37.3 l x 5.0 d cm)

Topside Unit

Velocity range

- 4595 – 5250 ft/sec (1400 – 1600 m/sec)

Resolution

- 0.1 ft/sec (0.1 m/sec)

Accuracy

- +/- 1 ft/sec (+/- 0.3 m/sec)

Power Requirement

- Three “C” cell batteries

Communications

- RS232, selectable baud rate

Dimensions

- 11.4 l x 5.5 w x 3.7 d inches
(29.0 l x 14.0 w x 9.4 d cm)

Weight

- 2.6 lbs (1.2 kg)

CABLE

- 4-conductor, Polyethylene-jacketed with Kevlar strength member

Breaking Strength

- 400 lbs (182 kg)

FEATURES

- Velocity profiles downloaded to a computer
- Handheld display/logger with computer interface
- Battery operated
- RS232/RS485
- Detachable cable (in lengths up to 100 meters)
- Sampling by depth or time
- Stainless steel probe
- Waterproof
- Lightweight
- Portable
- Optional transit cases



odom
HYDROGRAPHIC SYSTEMS

1450 Seaboard Avenue
Baton Rouge, Louisiana 70810-6261 USA
E-mail: email@odomhydrographic.com
www.odomhydrographic.com

DMS 132 Receiver

Table E.1 lists the characteristics of the DSM 132.

Table E.1 DMS 132 Receiver characteristics

Size	14.5 cm W x 5.1 cm H x 19.5 cm D (5.7 in W x 2.0 in H x 7.7 in D)
Weight	0.76 kg (1.68 lb)
Power	7 Watts (max), 10–32 VDC
Operating temperature	–20 °C to +65 °C (–4 °F to +149 °F)
Storage temperature	–30 °C to +85 °C (–22 °F to +185 °F)
Humidity	100% condensing, unit fully sealed
Casing	Dust-proof, waterproof, shock resistant

Combined Antenna

Table E.2 lists the physical characteristics of the combined antenna.

Table E.2 Combined antenna characteristics

	DSM 132 Receiver
Size	15.5 cm D x 14.0 cm H (6.1 in D x 5.5 in H)
Weight	0.55 Kg (1.2 lb)
Operating temperature	–30 °C to +65 °C (–22 °F to +149 °F)
Storage temperature	–40 °C to +80 °C (–40 °F to +176 °F)
Humidity	100% condensing, unit fully sealed
Casing	Dust-proof, waterproof, shock resistant

GPS Channels

Table E.3 lists the performance characteristics of GPS channels.

Table E.3 GPS channels performance characteristics

General	12-channel, parallel tracking L1 1571.42 MHz C/A code and carrier phase filtered measurements and multi-bit digitizer
Update rate	Selectable 1, 2, 5, or 10 Hz output rate)
Differential speed accuracy	0.16 kph (0.1 mph)
Differential position accuracy	Less than 1 m horizontal RMS if all the following criteria are met: At least 5 satellites, PDOP < 4 RTCM SC-104 Standard format broadcast from a Trimble DSM 132RS or equivalent reference station
Time to first fix	< 30 seconds, typical
NMEA messages	GGA, ¹ GLL, GSR, GSA ¹ , GST, GSV, MSS, PTNLDG, PTNL, PTNLEV, PTNLID, PTNLISM, RMC ¹ , VTG ¹ , XTE, ZDA

¹By default, the receiver is configured to output GGA, GSA, RMC, and VTG messages at an 1 Hz (1 position/second) update rate.

Beacon Channels

Table E.4 lists the characteristics of the beacon channels.

Table E.4 Beacon Channels

Frequency range	283.5 kHz to 325.0 kHz
Channel Spacing	500 Hz
Beacon modulation	50, 100, and 200 bits/second
Signal strength	10 μ V/meter minimum
Dynamic range	100 dB
Channel selectivity	70 dB @ > 500 Hz offset

Table E.4 Beacon Channels (continued)

Frequency offset	17 ppm maximum
3rd order intercept	+15 dBm @ RF input (min. AGC setting)
Beacon acquisition time	<5 seconds, typical
Operating modes	Auto Power, Auto Range, and Manual

L-Band Satellite Differential Correction Receiver

Table E.5 lists the characteristics of the L-band satellite differential correction receiver with multiple vendor support.

Table E.5 L-Band satellite differential correction receiver with multiple vendor support characteristics

Bit error rate	10^{-5} for Eb/N of >5.5 dB
Acquisition and reacquisition time	<5 seconds, typical
Frequency band	1525–1560 MHz
Channel spacing	5 kHz

Receiver Default Settings

Table E.6 lists the receiver default settings.

Table E.6 Receiver default settings

DGPS Source	WAAS/EGNOS
Dynamics	Land
Minimum elevation	8°
AMU mask	3
PDOP Mask	13°
PDOP 2D/3D switch	11
PV Filter	D&S (Dynamic and Static mode)

Table E.6 Receiver default settings (continued)

C.C. Filter	Enhanced
DGPS mode	Auto On/Off
DGPS correction age limit	30 seconds
Pos fix rate	1 Hz

APPENDIX II

Bathymetry Data Cleaning to PSS

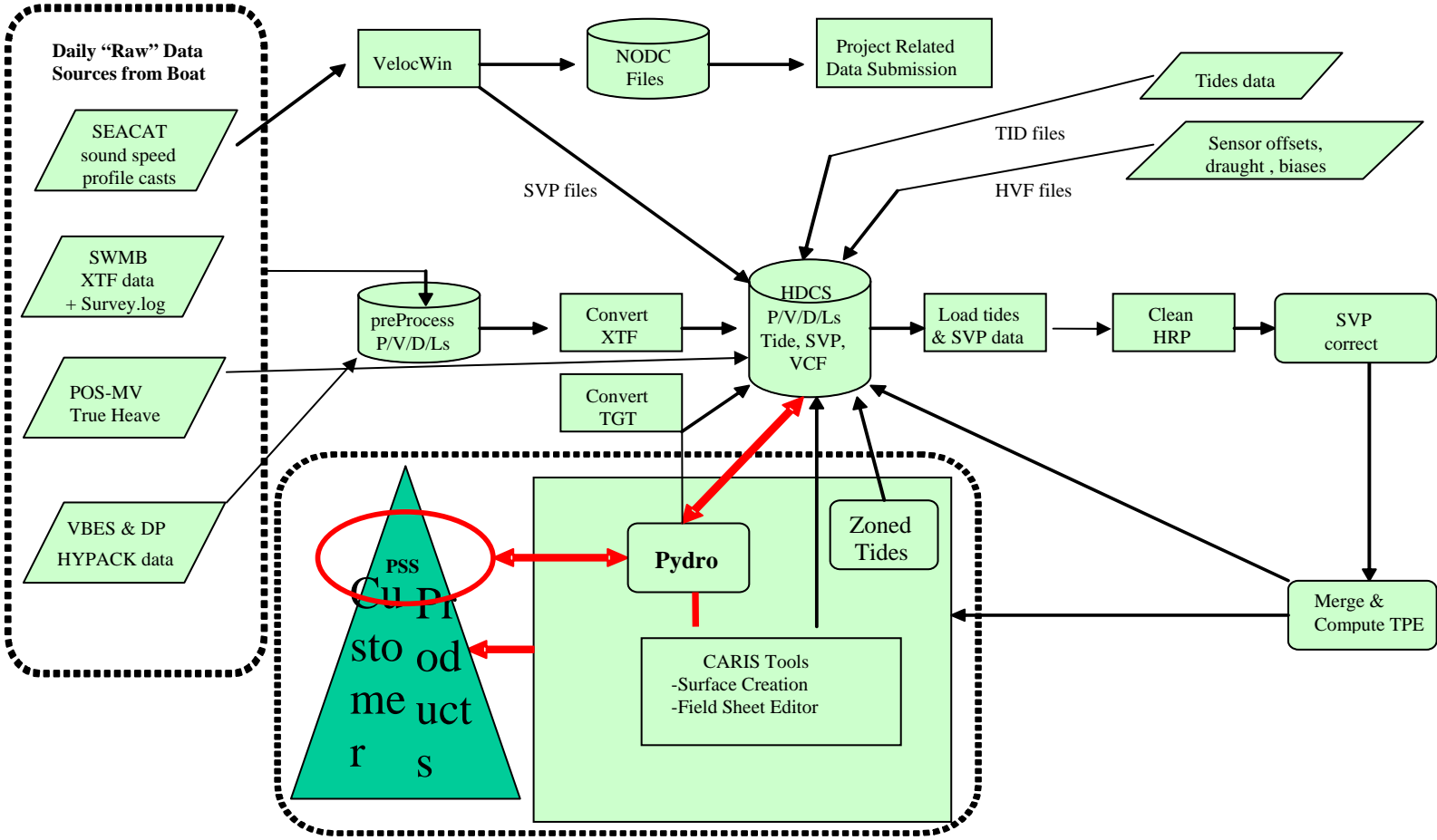

Data Flow Diagram -- Data Integration with Pydro

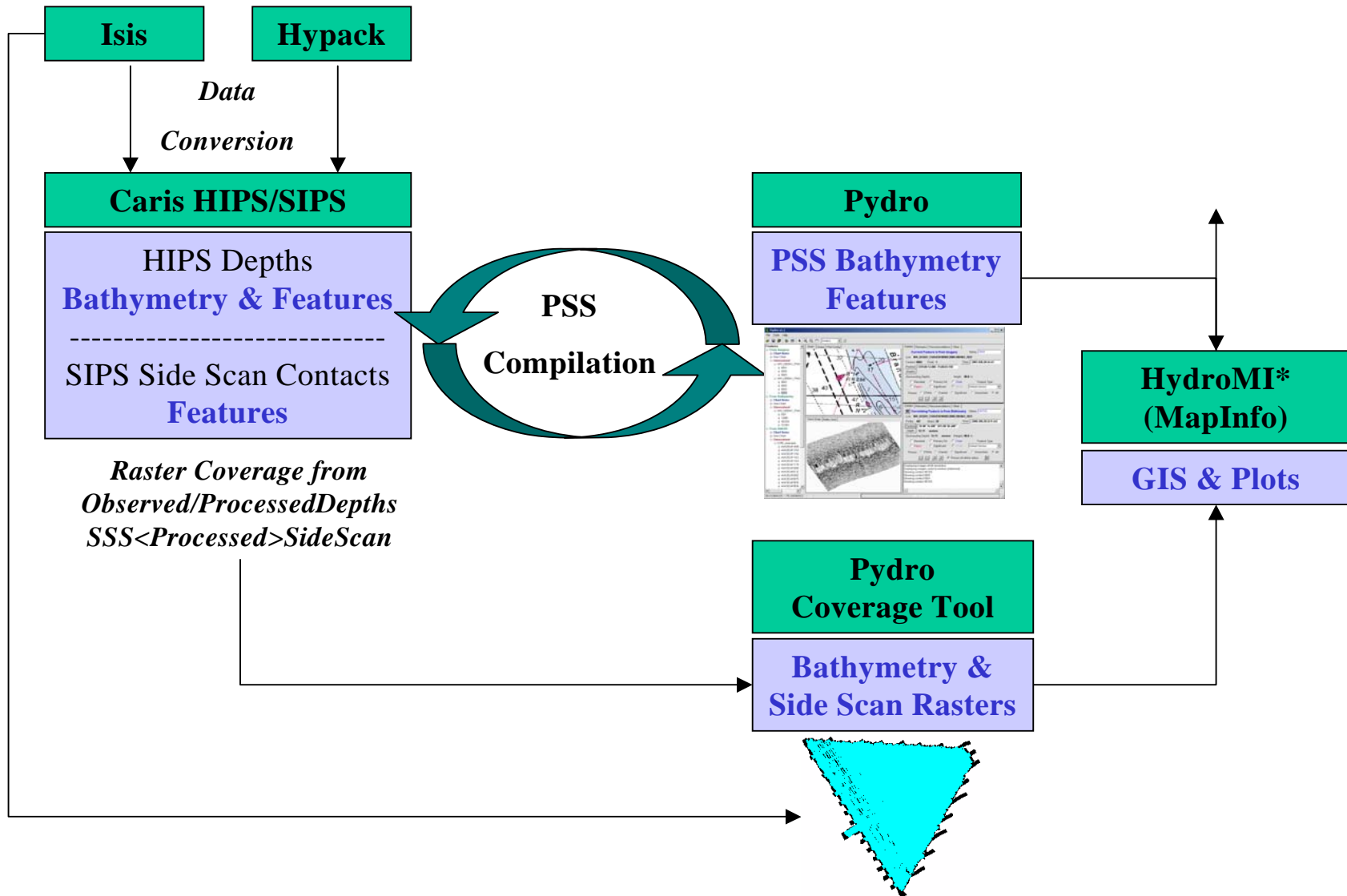

SIPS Side Scan Data

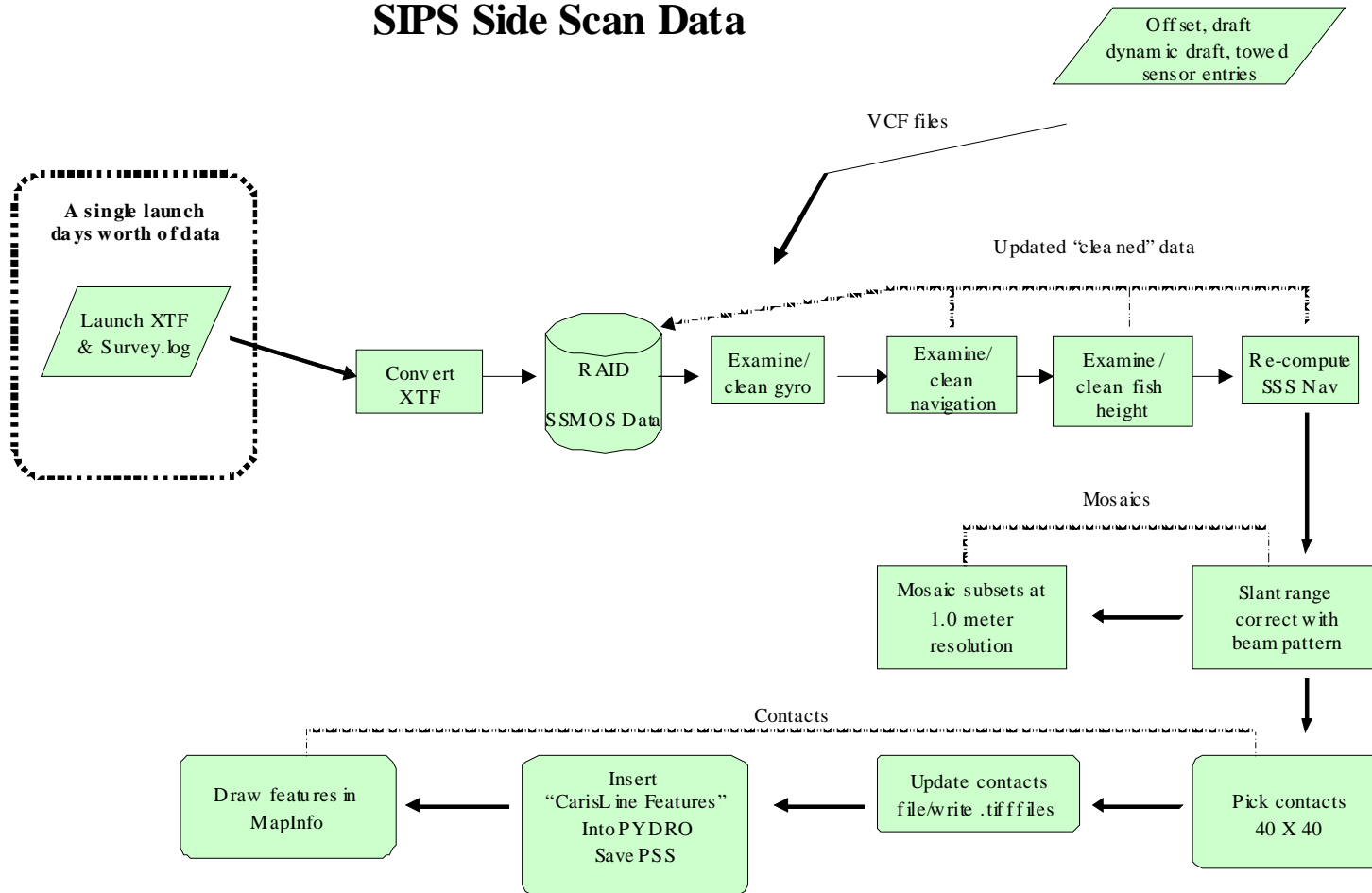

Vessel Name: NRT7_S3004_C3D_100.hvf

Vessel created: The vessel file was not saved at the time this report was generated.

Depth Sensor:

Sensor Class: Swath
Time Stamp: 2006-121 00:00

Transducer #1:

Pitch Offset: 0.000
Roll Offset: 0.000
Azimuth Offset: 0.000

DeltaX: 1.376
DeltaY: -2.050
DeltaZ: 0.811

Manufacturer: Benthos
Model: Unknown
Serial Number:

Depth Sensor:

Sensor Class: Swath
Time Stamp: 2007-079 00:00

Transducer #1:

Pitch Offset: -0.300
Roll Offset: -0.300
Azimuth Offset: -1.900

DeltaX: 1.284
DeltaY: -1.996
DeltaZ: 0.612

Manufacturer: Benthos
Model: benthosC3d
Serial Number:

Navigation Sensor:

Time Stamp: 2005-299 00:00

Comments Offset applied in POS

Latency 0.000

DeltaX: 0.000

DeltaY: 0.000

DeltaZ: 0.000

Manufacturer: Applanix

Model: POSMV v4

Serial Number: (null)

Gyro Sensor:

Time Stamp: 2005-299 00:00

Comments (null)

Latency 0.000

Heave Sensor:

Time Stamp: 2005-299 00:00

Comments RP to IMU

Apply Yes

Latency 0.000

DeltaX: 0.000

DeltaY: 0.000

DeltaZ: 0.000

Offset: 0.000

Manufacturer: (null)

Model: (null)

Serial Number: (null)

Pitch Sensor:

Time Stamp: 2005-299 00:00

Comments (null)

Apply Yes

Latency 0.000

Pitch offset: 0.000

Manufacturer: (null)

Model: (null)

Serial Number: (null)

Roll Sensor:

Time Stamp: 2005-299 00:00

Comments (null)

Apply Yes

Latency 0.000

Roll offset: 0.000

Manufacturer: (null)

Model: (null)

Serial Number: (null)

Draft Sensor:

Time Stamp: 2005-299 00:00

Apply Yes

Comments From S3002

Entry 1) Draft: 0.000 Speed: 0.000

Entry 2) Draft: 0.101 Speed: 2.000

Entry 3) Draft: 0.108 Speed: 3.500

Entry 4) Draft: 0.202 Speed: 4.500

Entry 5) Draft: 0.204 Speed: 6.000

Entry 6) Draft: 0.076 Speed: 7.500

Time Stamp: 2005-305 00:00

Apply Yes

Comments Steve's Calc

Entry 1) Draft: 0.000 Speed: 1.800
Entry 2) Draft: -0.020 Speed: 4.200
Entry 3) Draft: -0.020 Speed: 5.000
Entry 4) Draft: -0.060 Speed: 6.400
Entry 5) Draft: -0.020 Speed: 7.300
Entry 6) Draft: 0.000 Speed: 8.200

TPE

Time Stamp: 2007-079 00:00

Comments Offsets corrected in POS, SDs from HSTD2007_2

Offsets

Motion sensing unit to the transducer 1

X Head 1 0.000

Y Head 1 0.000

Z Head 1 0.000

Motion sensing unit to the transducer 2

X Head 2 0.000

Y Head 2 0.000

Z Head 2 0.000

Navigation antenna to the transducer 1

X Head 1 0.000

Y Head 1 0.000

Z Head 1 0.000

Navigation antenna to the transducer 2

X Head 2 0.000

Y Head 2 0.000

Z Head 2 0.000

Roll offset of transducer number 1 0.000

Roll offset of transducer number 2 0.000

Heave Error: 0.050 or 5.000" of heave amplitude.

Measurement errors: 0.050

Motion sensing unit alignment errors

Gyro:1.000 Pitch:1.000 Roll:1.000

Gyro measurement error: 0.020

Roll measurement error: 0.020

Pitch measurement error: 0.020

Navigation measurement error: 1.000

Transducer timing error: 0.010

Navigation timing error: 0.010
Gyro timing error: 0.010
Heave timing error: 0.010
PitchTimingStdDev: 0.010
Roll timing error: 0.010
Sound Velocity speed measurement error: 0.000
Surface sound speed measurement error: 0.000
Tide measurement error: 0.000
Tide zoning error: 0.000
Speed over ground measurement error: 0.030
Dynamic loading measurement error: 0.150
Static draft measurement error: 0.100
Delta draft measurement error: 0.020
StDev Comment: `éfJ Ĩ...J`õ...JPõ...J°đ...J €...J@í...J°k€JàZ€J€Ó...Ja

Svp Sensor:

Time Stamp: 2006-121 00:00

Comments

Svp #1:

Pitch Offset: 0.000
Roll Offset: 0.000
Azimuth Offset: 0.000

DeltaX: 1.376
DeltaY: -2.050
DeltaZ: 0.811

SVP #2:

Pitch Offset: 0.000
Roll Offset: 0.000
Azimuth Offset: 0.000

DeltaX: 0.000
DeltaY: 0.000
DeltaZ: 0.000

Time Stamp: 2007-079 00:00

Comments (null)

Svp #1:

Pitch Offset: 0.000
Roll Offset: 0.000
Azimuth Offset: 0.000

DeltaX: 1.284
DeltaY: -1.996
DeltaZ: 0.612

SVP #2:

Pitch Offset: 0.000
Roll Offset: 0.000
Azimuth Offset: 0.000

DeltaX: 0.000
DeltaY: 0.000
DeltaZ: 0.000

WaterLine:

Time Stamp: 2005-300 00:00

Comments RP to WL
Apply Yes
WaterLine -0.080

Vessel Name: NRT7_S3004_C3D_200.hvf

Vessel created: The vessel file was not saved at the time this report was generated.

Depth Sensor:

Sensor Class: Swath
Time Stamp: 2006-121 00:00

Transducer #1:

Pitch Offset: 0.000
Roll Offset: 0.000
Azimuth Offset: 0.000

DeltaX: 1.376
DeltaY: -2.050
DeltaZ: 0.811

Manufacturer: Benthos
Model: Unknown
Serial Number:

Depth Sensor:

Sensor Class: Swath
Time Stamp: 2007-079 00:00

Transducer #1:

Pitch Offset: -0.300
Roll Offset: -0.300
Azimuth Offset: -1.900

DeltaX: 1.284
DeltaY: -1.996
DeltaZ: 0.612

Manufacturer: Benthos
Model: benthosC3d
Serial Number:

Navigation Sensor:

Time Stamp: 2005-299 00:00

Comments Offset applied in POS

Latency 0.000

DeltaX: 0.000

DeltaY: 0.000

DeltaZ: 0.000

Manufacturer: Applanix

Model: POSMV v4

Serial Number: (null)

Gyro Sensor:

Time Stamp: 2005-299 00:00

Comments (null)

Latency 0.000

Heave Sensor:

Time Stamp: 2005-299 00:00

Comments RP to IMU

Apply Yes

Latency 0.000

DeltaX: 0.000

DeltaY: 0.000

DeltaZ: 0.000

Offset: 0.000

Manufacturer: (null)

Model: (null)

Serial Number: (null)

Pitch Sensor:

Time Stamp: 2005-299 00:00

Comments (null)

Apply Yes

Latency 0.000

Pitch offset: 0.000

Manufacturer: (null)

Model: (null)

Serial Number: (null)

Roll Sensor:

Time Stamp: 2005-299 00:00

Comments (null)

Apply Yes

Latency 0.000

Roll offset: 0.000

Manufacturer: (null)

Model: (null)

Serial Number: (null)

Draft Sensor:

Time Stamp: 2005-299 00:00

Apply Yes

Comments From S3002

Entry 1) Draft: 0.000 Speed: 0.000

Entry 2) Draft: 0.101 Speed: 2.000

Entry 3) Draft: 0.108 Speed: 3.500

Entry 4) Draft: 0.202 Speed: 4.500

Entry 5) Draft: 0.204 Speed: 6.000

Entry 6) Draft: 0.076 Speed: 7.500

Time Stamp: 2005-305 00:00

Apply Yes

Comments Steve's Calc

Entry 1) Draft: 0.000 Speed: 1.800
Entry 2) Draft: -0.020 Speed: 4.200
Entry 3) Draft: -0.020 Speed: 5.000
Entry 4) Draft: -0.060 Speed: 6.400
Entry 5) Draft: -0.020 Speed: 7.300
Entry 6) Draft: 0.000 Speed: 8.200

TPE

Time Stamp: 2007-079 00:00

Comments Offsets corrected in POS, SDs from HSTD2007_2
Offsets

Motion sensing unit to the transducer 1

X Head 1 0.000

Y Head 1 0.000

Z Head 1 0.000

Motion sensing unit to the transducer 2

X Head 2 0.000

Y Head 2 0.000

Z Head 2 0.000

Navigation antenna to the transducer 1

X Head 1 0.000

Y Head 1 0.000

Z Head 1 0.000

Navigation antenna to the transducer 2

X Head 2 0.000

Y Head 2 0.000

Z Head 2 0.000

Roll offset of transducer number 1 0.000

Roll offset of transducer number 2 0.000

Heave Error: 0.050 or 5.000" of heave amplitude.

Measurement errors: 0.050

Motion sensing unit alignment errors

Gyro:1.000 Pitch:1.000 Roll:1.000

Gyro measurement error: 0.020

Roll measurement error: 0.020

Pitch measurement error: 0.020

Navigation measurement error: 1.000

Transducer timing error: 0.010

Navigation timing error: 0.010
Gyro timing error: 0.010
Heave timing error: 0.010
PitchTimingStdDev: 0.010
Roll timing error: 0.010
Sound Velocity speed measurement error: 0.000
Surface sound speed measurement error: 0.000
Tide measurement error: 0.000
Tide zoning error: 0.000
Speed over ground measurement error: 0.030
Dynamic loading measurement error: 0.150
Static draft measurement error: 0.100
Delta draft measurement error: 0.020
StDev Comment: `éfJ Ĩ...J`õ...JPõ...J°đ...J €...J@í...J°k€JàZ€J€Ó...Ja

Svp Sensor:

Time Stamp: 2006-121 00:00

Comments

Svp #1:

Pitch Offset: 0.000
Roll Offset: 0.000
Azimuth Offset: 0.000

DeltaX: 1.376
DeltaY: -2.050
DeltaZ: 0.811

SVP #2:

Pitch Offset: 0.000
Roll Offset: 0.000
Azimuth Offset: 0.000

DeltaX: 0.000
DeltaY: 0.000
DeltaZ: 0.000

Time Stamp: 2007-079 00:00

Comments (null)

Svp #1:

Pitch Offset: 0.000
Roll Offset: 0.000
Azimuth Offset: 0.000

DeltaX: 1.284
DeltaY: -1.996
DeltaZ: 0.612

SVP #2:

Pitch Offset: 0.000
Roll Offset: 0.000
Azimuth Offset: 0.000

DeltaX: 0.000
DeltaY: 0.000
DeltaZ: 0.000

WaterLine:

Time Stamp: 2005-300 00:00

Comments RP to WL
Apply Yes
WaterLine -0.080

Vessel Name: NRT7_S3004_C3D.hvf

Vessel created: The vessel file was not saved at the time this report was generated.

Depth Sensor:

Sensor Class: Swath
Time Stamp: 2006-121 00:00

Transducer #1:

Pitch Offset: 0.000
Roll Offset: 0.000
Azimuth Offset: 0.000

DeltaX: 1.376
DeltaY: -2.050
DeltaZ: 0.811

Manufacturer: Benthos
Model: Unknown
Serial Number:

Depth Sensor:

Sensor Class: Swath
Time Stamp: 2007-079 00:00

Transducer #1:

Pitch Offset: -0.300
Roll Offset: -0.300
Azimuth Offset: -1.900

DeltaX: 1.284
DeltaY: -1.996
DeltaZ: 0.612

Manufacturer: Benthos
Model: benthosC3d
Serial Number:

Navigation Sensor:

Time Stamp: 2005-299 00:00

Comments Offset applied in POS

Latency 0.000

DeltaX: 0.000

DeltaY: 0.000

DeltaZ: 0.000

Manufacturer: Applanix

Model: POSMV v4

Serial Number: (null)

Gyro Sensor:

Time Stamp: 2005-299 00:00

Comments (null)

Latency 0.000

Heave Sensor:

Time Stamp: 2005-299 00:00

Comments RP to IMU

Apply Yes

Latency 0.000

DeltaX: 0.000

DeltaY: 0.000

DeltaZ: 0.000

Offset: 0.000

Manufacturer: (null)

Model: (null)

Serial Number: (null)

Pitch Sensor:

Time Stamp: 2005-299 00:00

Comments (null)

Apply Yes

Latency 0.000

Pitch offset: 0.000

Manufacturer: (null)

Model: (null)

Serial Number: (null)

Roll Sensor:

Time Stamp: 2005-299 00:00

Comments (null)

Apply Yes

Latency 0.000

Roll offset: 0.000

Manufacturer: (null)

Model: (null)

Serial Number: (null)

Draft Sensor:

Time Stamp: 2005-299 00:00

Apply Yes

Comments From S3002

Entry 1) Draft: 0.000 Speed: 0.000

Entry 2) Draft: 0.101 Speed: 2.000

Entry 3) Draft: 0.108 Speed: 3.500

Entry 4) Draft: 0.202 Speed: 4.500

Entry 5) Draft: 0.204 Speed: 6.000

Entry 6) Draft: 0.076 Speed: 7.500

Time Stamp: 2005-305 00:00

Apply Yes

Comments Steve's Calc

Entry 1) Draft: 0.000 Speed: 1.800
Entry 2) Draft: -0.020 Speed: 4.200
Entry 3) Draft: -0.020 Speed: 5.000
Entry 4) Draft: -0.060 Speed: 6.400
Entry 5) Draft: -0.020 Speed: 7.300
Entry 6) Draft: 0.000 Speed: 8.200

TPE

Time Stamp: 2007-079 00:00

Comments Offsets corrected in POS, SDs from HSTD2007_2
Offsets

Motion sensing unit to the transducer 1

X Head 1 0.000

Y Head 1 0.000

Z Head 1 0.000

Motion sensing unit to the transducer 2

X Head 2 0.000

Y Head 2 0.000

Z Head 2 0.000

Navigation antenna to the transducer 1

X Head 1 0.000

Y Head 1 0.000

Z Head 1 0.000

Navigation antenna to the transducer 2

X Head 2 0.000

Y Head 2 0.000

Z Head 2 0.000

Roll offset of transducer number 1 0.000

Roll offset of transducer number 2 0.000

Heave Error: 0.050 or 5.000" of heave amplitude.

Measurement errors: 0.050

Motion sensing unit alignment errors

Gyro:1.000 Pitch:1.000 Roll:1.000

Gyro measurement error: 0.020

Roll measurement error: 0.020

Pitch measurement error: 0.020

Navigation measurement error: 1.000

Transducer timing error: 0.010

Navigation timing error: 0.010
Gyro timing error: 0.010
Heave timing error: 0.010
PitchTimingStdDev: 0.010
Roll timing error: 0.010
Sound Velocity speed measurement error: 0.000
Surface sound speed measurement error: 0.000
Tide measurement error: 0.000
Tide zoning error: 0.000
Speed over ground measurement error: 0.030
Dynamic loading measurement error: 0.150
Static draft measurement error: 0.100
Delta draft measurement error: 0.020
StDev Comment: `éfJ Ĩ...J`õ...JPõ...J°đ...J €...J@í...J°k€JàZ€J€Ó...Ja

Svp Sensor:

Time Stamp: 2006-121 00:00

Comments

Svp #1:

Pitch Offset: 0.000
Roll Offset: 0.000
Azimuth Offset: 0.000

DeltaX: 1.376
DeltaY: -2.050
DeltaZ: 0.811

SVP #2:

Pitch Offset: 0.000
Roll Offset: 0.000
Azimuth Offset: 0.000

DeltaX: 0.000
DeltaY: 0.000
DeltaZ: 0.000

Time Stamp: 2007-079 00:00

Comments (null)

Svp #1:

Pitch Offset: 0.000
Roll Offset: 0.000
Azimuth Offset: 0.000

DeltaX: 1.284
DeltaY: -1.996
DeltaZ: 0.612

SVP #2:

Pitch Offset: 0.000
Roll Offset: 0.000
Azimuth Offset: 0.000

DeltaX: 0.000
DeltaY: 0.000
DeltaZ: 0.000

WaterLine:

Time Stamp: 2005-300 00:00

Comments RP to WL
Apply Yes
WaterLine -0.080

Vessel Name: NRT7_S3004_Reson8125.hvf

Vessel created: The vessel file was not saved at the time this report was generated.

Depth Sensor:

Sensor Class: Swath
Time Stamp: 2005-299 00:00

Transducer #1:

Pitch Offset: 2.040
Roll Offset: -0.360
Azimuth Offset: -0.320

DeltaX: -1.376
DeltaY: -2.050
DeltaZ: 0.610

Manufacturer: Reson
Model: sb8125
Serial Number:

Depth Sensor:

Sensor Class: Swath
Time Stamp: 2006-228 00:00

Transducer #1:

Pitch Offset: -0.550
Roll Offset: 0.790
Azimuth Offset: -2.000

DeltaX: 1.343
DeltaY: -2.104
DeltaZ: 0.610

Manufacturer: Reson
Model: sb8125
Serial Number:

Depth Sensor:

Sensor Class: Swath
Time Stamp: 2006-310 00:00

Transducer #1:

Pitch Offset: -1.250
Roll Offset: 0.650
Azimuth Offset: 0.790

DeltaX: 1.343
DeltaY: -2.104
DeltaZ: 0.610

Manufacturer: Reson
Model: sb8125
Serial Number:

Depth Sensor:

Sensor Class: Swath
Time Stamp: 2006-317 00:00

Transducer #1:

Pitch Offset: -1.600
Roll Offset: 0.850
Azimuth Offset: 0.800

DeltaX: 1.343
DeltaY: -2.104
DeltaZ: 0.610

Manufacturer: Reson
Model: sb8125
Serial Number:

Navigation Sensor:

Time Stamp: 2005-299 00:00

Comments Offset applied in POS

Latency 0.000

DeltaX: 0.000

DeltaY: 0.000

DeltaZ: 0.000

Manufacturer: Applanix

Model: POSMV v4

Serial Number: (null)

Gyro Sensor:

Time Stamp: 2005-299 00:00

Comments (null)

Latency 0.000

Heave Sensor:

Time Stamp: 2005-299 00:00

Comments RP to IMU

Apply Yes

Latency -0.300

DeltaX: 0.000

DeltaY: 0.000

DeltaZ: 0.000

Offset: 0.000

Manufacturer: (null)

Model: (null)

Serial Number: (null)

Pitch Sensor:

Time Stamp: 2005-299 00:00

Comments (null)

Apply Yes

Latency 0.000

Pitch offset: 0.000

Manufacturer: (null)

Model: (null)

Serial Number: (null)

Roll Sensor:

Time Stamp: 2005-299 00:00

Comments (null)

Apply Yes

Latency 0.000

Roll offset: 0.000

Manufacturer: (null)

Model: (null)

Serial Number: (null)

Draft Sensor:

Time Stamp: 2005-299 00:00

Apply Yes

Comments From S3002

Entry 1) Draft: 0.000 Speed: 0.000

Entry 2) Draft: 0.101 Speed: 2.000

Entry 3) Draft: 0.108 Speed: 3.500

Entry 4) Draft: 0.202 Speed: 4.500

Entry 5) Draft: 0.204 Speed: 6.000

Entry 6) Draft: 0.076 Speed: 7.500

TPE

Time Stamp: 2006-310 00:00

Comments

Offsets

Motion sensing unit to the transducer 1

X Head 1 1.343

Y Head 1 -2.104

Z Head 1 0.610

Motion sensing unit to the transducer 2

X Head 2 0.000

Y Head 2 0.000

Z Head 2 0.000

Navigation antenna to the transducer 1

X Head 1 0.000

Y Head 1 0.000

Z Head 1 0.000

Navigation antenna to the transducer 2

X Head 2 0.000

Y Head 2 0.000

Z Head 2 0.000

Roll offset of transducer number 1 0.000

Roll offset of transducer number 2 0.000

Heave Error: 0.050 or 5.000" of heave amplitude.

Measurement errors: 0.001

Motion sensing unit alignment errors

Gyro:1.000 Pitch:1.000 Roll:1.000

Gyro measurement error: 0.020

Roll measurement error: 0.020

Pitch measurement error: 0.020

Navigation measurement error: 1.000

Transducer timing error: 0.010

Navigation timing error: 0.010

Gyro timing error: 0.010

Heave timing error: 0.010

PitchTimingStdDev: 0.010

Roll timing error: 0.010

Sound Velocity speed measurement error: 4.000

Surface sound speed measurement error: 0.500

Tide measurement error: 0.020

Tide zoning error: 0.020

Speed over ground measurement error: 0.030

Dynamic loading measurement error: 0.150

Static draft measurement error: 0.100

Delta draft measurement error: 0.100

StDev Comment: `éfJ Ĩ...J ð...JPð...J°ð...J €...J@í...J°k€JàZ€J€Ó...Ja

Svp Sensor:

Time Stamp: 2005-299 00:00

Comments (null)

Svp #1:

Pitch Offset: 0.000
Roll Offset: 0.000
Azimuth Offset: 0.000

DeltaX: -1.376
DeltaY: -2.050
DeltaZ: 0.610

SVP #2:

Pitch Offset: 0.000
Roll Offset: 0.000
Azimuth Offset: 0.000

DeltaX: 0.000
DeltaY: 0.000
DeltaZ: 0.000

Time Stamp: 2006-228 00:00

Comments (null)

Svp #1:

Pitch Offset: 0.000
Roll Offset: 0.000
Azimuth Offset: 0.000

DeltaX: 1.343
DeltaY: -2.104
DeltaZ: 0.610

SVP #2:

Pitch Offset: 0.000
Roll Offset: 0.000
Azimuth Offset: 0.000

DeltaX: 0.000
DeltaY: 0.000
DeltaZ: 0.000

Time Stamp: 2006-307 00:00

Comments

Svp #1:

Pitch Offset: 0.000
Roll Offset: 0.000
Azimuth Offset: 0.000

DeltaX: 0.000
DeltaY: 0.000
DeltaZ: 0.000

SVP #2:

Pitch Offset: 0.000
Roll Offset: 0.000
Azimuth Offset: 0.000

DeltaX: 0.000
DeltaY: 0.000
DeltaZ: 0.000

Time Stamp: 2006-310 00:00

Comments

Svp #1:

Pitch Offset: 0.000
Roll Offset: 0.000
Azimuth Offset: 0.000

DeltaX: 1.343
DeltaY: -2.104
DeltaZ: 0.610

SVP #2:

Pitch Offset: 0.000
Roll Offset: 0.000
Azimuth Offset: 0.000

DeltaX: 0.000
DeltaY: 0.000
DeltaZ: 0.000

Time Stamp: 2006-317 00:00

Comments

Svp #1:

Pitch Offset: 0.000
Roll Offset: 0.000
Azimuth Offset: 0.000

DeltaX: 1.343
DeltaY: -2.104
DeltaZ: 0.610

SVP #2:

Pitch Offset: 0.000
Roll Offset: 0.000
Azimuth Offset: 0.000

DeltaX: 0.000
DeltaY: 0.000
DeltaZ: 0.000

WaterLine:

Time Stamp: 2005-300 00:00

Comments RP to WL
Apply Yes
WaterLine -0.080

Vessel Name: NRT7_S3004_SB.hvf

Vessel created: The vessel file was not saved at the time this report was generated.

Depth Sensor:

Sensor Class: Swath
Time Stamp: 2006-274 00:00

Transducer #1:

Pitch Offset: 0.000
Roll Offset: 0.000
Azimuth Offset: 0.000

DeltaX: -0.276
DeltaY: 0.040
DeltaZ: 0.255

Manufacturer: Odom
Model: oecv
Serial Number:

Navigation Sensor:

Time Stamp: 2005-299 00:00

Comments Offset applied in POS
Latency 0.040
DeltaX: 0.000
DeltaY: 0.000
DeltaZ: 0.000

Manufacturer: Applanix
Model: POSMV v4
Serial Number: (null)

Gyro Sensor:

Time Stamp: 2005-299 00:00

Comments (null)

Latency 0.000

Heave Sensor:

Time Stamp: 2005-299 00:00

Comments RP to IMU

Apply Yes

Latency 0.000

DeltaX: 0.000

DeltaY: 0.000

DeltaZ: 0.000

Offset: 0.000

Manufacturer: (null)

Model: (null)

Serial Number: (null)

Pitch Sensor:

Time Stamp: 2005-299 00:00

Comments (null)

Apply Yes

Latency 0.000

Pitch offset: 0.000

Manufacturer: (null)

Model: (null)

Serial Number: (null)

Roll Sensor:

Time Stamp: 2005-299 00:00

Comments (null)

Apply Yes

Latency 0.000

Roll offset: 0.000

Manufacturer: (null)

Model: (null)

Serial Number: (null)

Draft Sensor:

Time Stamp: 2005-299 00:00

Apply Yes

Comments From S3002

Entry 1) Draft: 0.000 Speed: 0.000

Entry 2) Draft: 0.101 Speed: 2.000

Entry 3) Draft: 0.108 Speed: 3.500

Entry 4) Draft: 0.202 Speed: 4.500

Entry 5) Draft: 0.204 Speed: 6.000

Entry 6) Draft: 0.076 Speed: 7.500

Time Stamp: 2005-305 00:00

Apply Yes

Comments Steve's Calc

Entry 1) Draft: 0.000 Speed: 1.800

Entry 2) Draft: -0.020 Speed: 4.200

Entry 3) Draft: -0.020 Speed: 5.000

Entry 4) Draft: -0.060 Speed: 6.400

Entry 5) Draft: -0.020 Speed: 7.300

Entry 6) Draft: 0.000 Speed: 8.200

Svp Sensor:

Time Stamp: 2006-121 00:00

Comments

Svp #1:

Pitch Offset: 0.000

Roll Offset: 0.000

Azimuth Offset: 0.000

DeltaX: 1.376

DeltaY: -2.050

DeltaZ: 0.811

SVP #2:

Pitch Offset: 0.000

Roll Offset: 0.000

Azimuth Offset: 0.000

DeltaX: 0.000

DeltaY: 0.000

DeltaZ: 0.000

Time Stamp: 2006-253 00:00

Comments

Svp #1:

Pitch Offset: 0.000

Roll Offset: 0.000

Azimuth Offset: 0.000

DeltaX: -0.276

DeltaY: 0.040

DeltaZ: 0.255

SVP #2:

Pitch Offset: 0.000

Roll Offset: 0.000

Azimuth Offset: 0.000

DeltaX: 0.000

DeltaY: 0.000

DeltaZ: 0.000

Time Stamp: 2006-273 00:00

Comments

Svp #1:

Pitch Offset: 0.000
Roll Offset: 0.000
Azimuth Offset: 0.000

DeltaX: 0.000
DeltaY: 0.000
DeltaZ: 0.000

SVP #2:

Pitch Offset: 0.000
Roll Offset: 0.000
Azimuth Offset: 0.000

DeltaX: 0.000
DeltaY: 0.000
DeltaZ: 0.000

Time Stamp: 2006-274 00:00

Comments

Svp #1:

Pitch Offset: 0.000
Roll Offset: 0.000
Azimuth Offset: 0.000

DeltaX: -0.276
DeltaY: 0.040
DeltaZ: 0.255

SVP #2:

Pitch Offset: 0.000
Roll Offset: 0.000
Azimuth Offset: 0.000

DeltaX: 0.000
DeltaY: 0.000
DeltaZ: 0.000

WaterLine:

Time Stamp: 2005-300 00:00

Comments RP to WL

Apply Yes

WaterLine -0.080

APPENDIX III

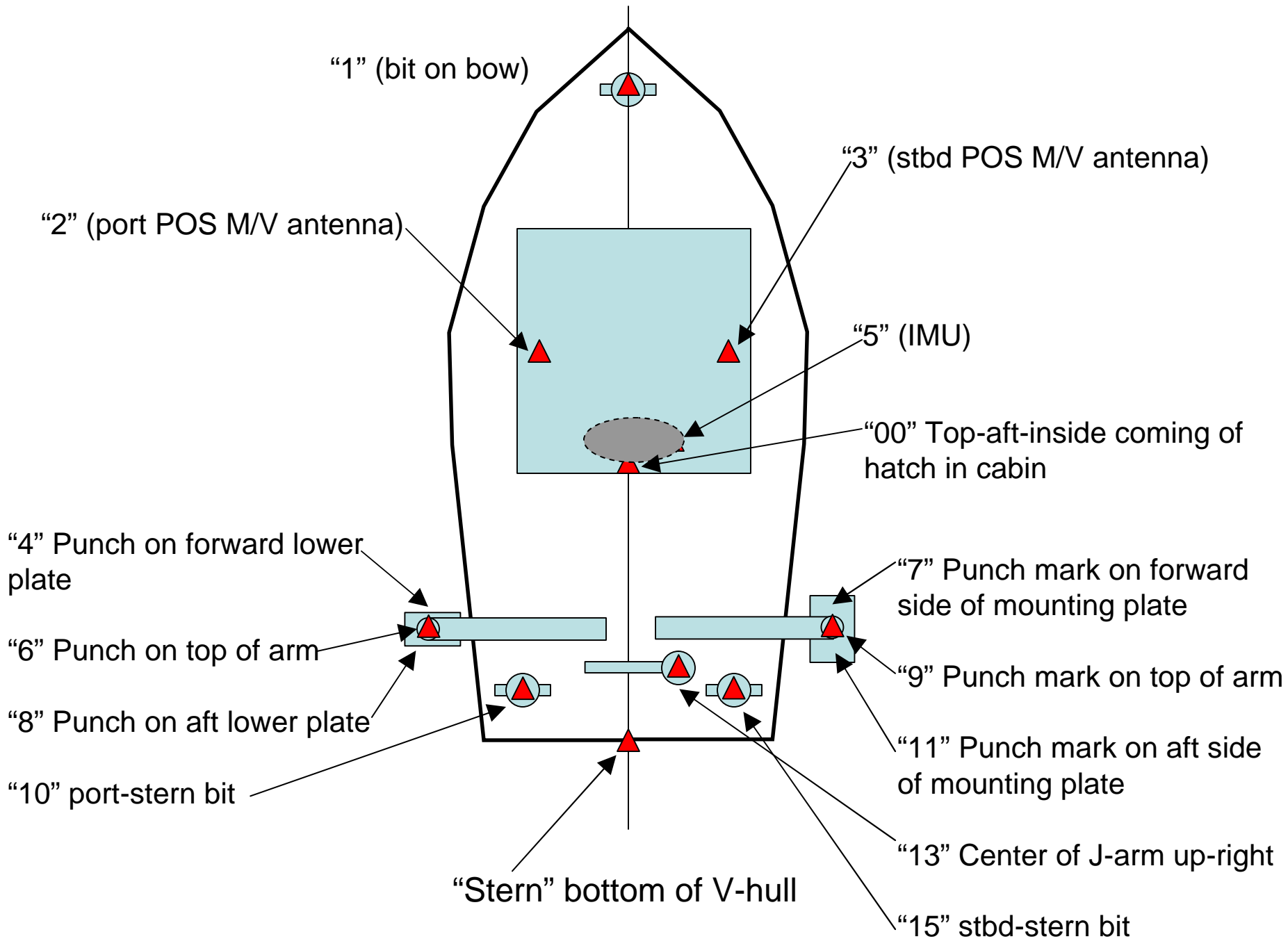

J-Arm

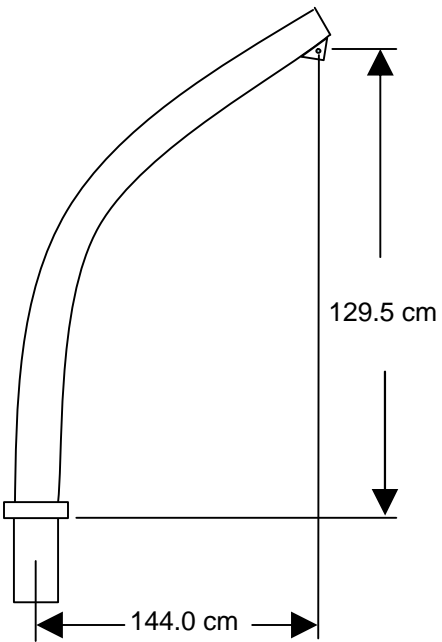

Port Sonar Arm

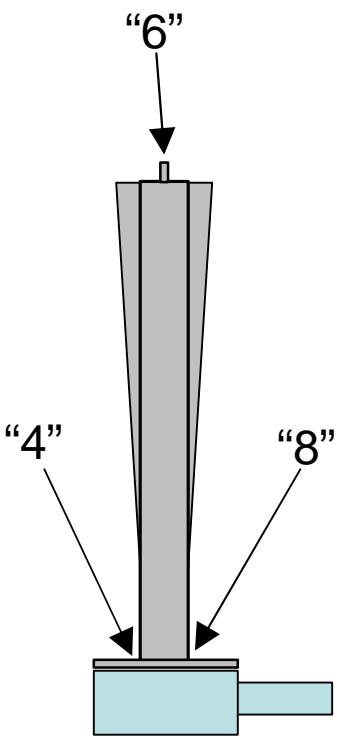

Stbd Sonar Arm

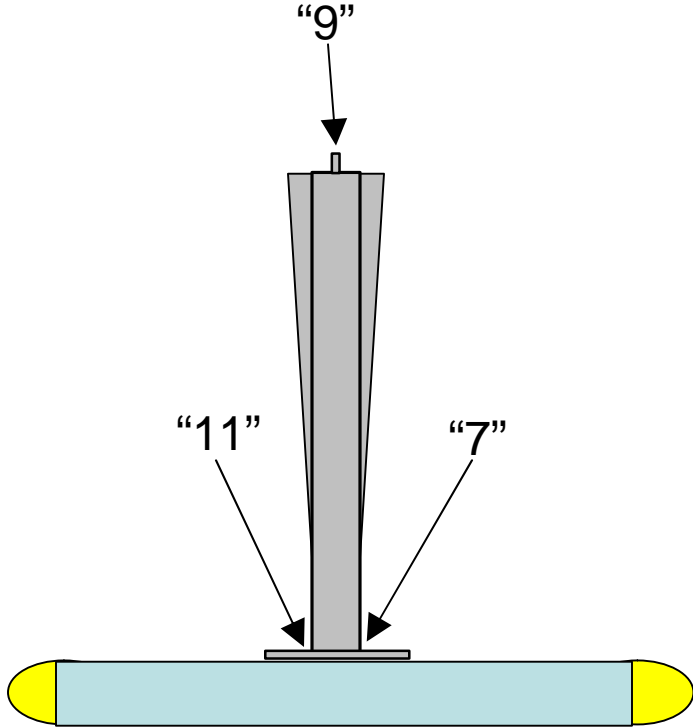

Point Name	Northing	Easting	Elevation
	fore/aft	port/stb	up/down
AMC	16.3631	-11.4689	0.67
BOWKEEL	4.2287	-0.0188	0.21
IMU	0.097	0.1113	-0.09
RP	0	0	0
STERNKEEL	-4.0363	-0.0188	-0.35
TP1	-0.9354	6.0829	0.52
1	4.632	0.001	1.29
2	1.256	-0.7956	2.47
3	1.2496	0.7606	2.47
11	-2.1143	1.3752	-0.42
9	-2.0498	1.3755	0.98
7	-1.8818	1.3729	-0.44
10	-2.9992	-1.1347	0.98
13	-2.548	0.5653	1.49
15	-2.9967	1.1135	1
	fwd (+)	stb (+)	up (+)

Note: Mounting arm was modified in summer/fall 2006. The port side arm became the stbd-side arm after the modification. We assume the position of the deployed pole did not change. BJW

The surveyed point were treated as the following in the new diagram and the signs and values adjusted accordingly:

8=7
6=9
4=11

	for/aft	port/stbd	up/down
7 to LW3D	-0.1143	-0.0889	-0.17145
RP to LWC3D F	-1.9961	1.284	-0.61145

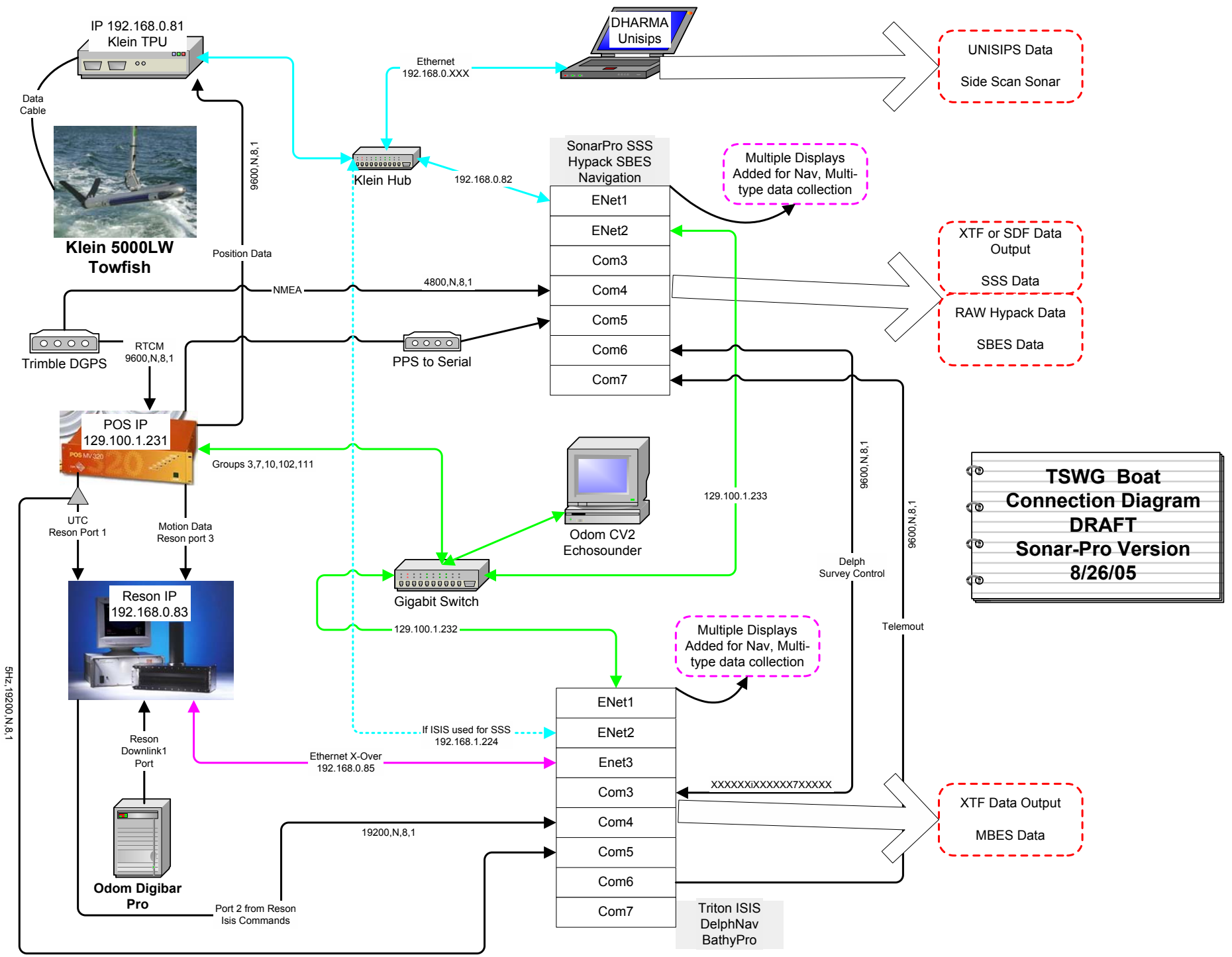

**TSWG Boat
Connection Diagram
DRAFT
Sonar-Pro Version
8/26/05**

Benthos C3D Wiring Diagram Aboard s3004

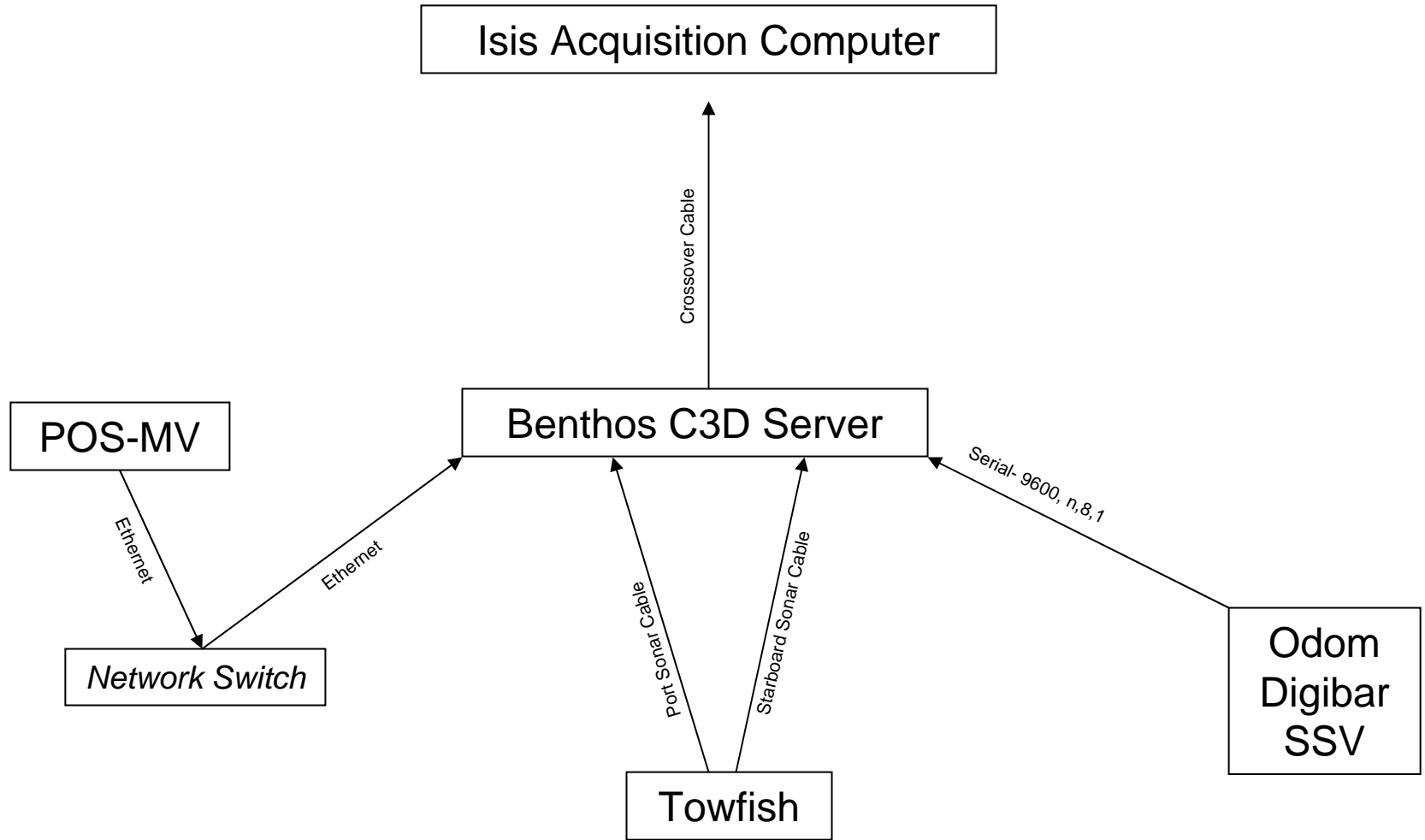

APPENDIX IV



SEA-BIRD ELECTRONICS, INC.

1808 - 136th Place Northeast, Bellevue, Washington 98005 USA

Phone: (425) 643-9866 Fax: (425) 643-9954 www.seabird.com

Conductivity Calibration Report

Customer:	NOAA - NRT-1		
Job Number:	44256	Date of Report:	1/9/2007
Model Number	SBE 19Plus	Serial Number:	19P37217-4677

Conductivity sensors are normally calibrated 'as received', without cleaning or adjustments, allowing a determination of sensor drift. If the calibration identifies a problem or indicates cell cleaning is necessary, then a second calibration is performed after work is completed. The 'as received' calibration is not performed if the sensor is damaged or non-functional, or by customer request.

An 'as received' calibration certificate is provided, listing the coefficients used to convert sensor frequency to conductivity. Users must choose whether the 'as received' calibration or the previous calibration better represents the sensor condition during deployment. In SEASOFT enter the chosen coefficients using the program SEACON. The coefficient 'slope' allows small corrections for drift between calibrations (consult the SEASOFT manual). Calibration coefficients obtained after a repair or cleaning apply only to subsequent data.

'AS RECEIVED CALIBRATION' Performed Not Performed

Date: Drift since last cal: PSU/month*

Comments:

'CALIBRATION AFTER CLEANING & REPLATINIZING' Performed Not Performed

Date: Drift since Last cal: PSU/month*

Comments:

**Measured at 3.0 S/m*

Cell cleaning and electrode replatinizing tend to 'reset' the conductivity sensor to its original condition. Lack of drift in post-cleaning-calibration indicates geometric stability of the cell and electrical stability of the sensor circuit.

SEA-BIRD ELECTRONICS, INC.

1808 136th Place N.E., Bellevue, Washington, 98005 USA

Phone: (425) 643 - 9866 Fax (425) 643 - 9954 Email: seabird@seabird.com

SENSOR SERIAL NUMBER: 4677
CALIBRATION DATE: 09-Jan-07

SBE19plus CONDUCTIVITY CALIBRATION DATA
PSS 1978: C(35,15,0) = 4.2914 Siemens/meter

COEFFICIENTS:

g = -1.054221e+000 CPcor = -9.5700e-008
h = 1.391571e-001 CTcor = 3.2500e-006
i = -2.948637e-004
j = 3.995315e-005

BATH TEMP (ITS-90)	BATH SAL (PSU)	BATH COND (Siemens/m)	INST FREQ (Hz)	INST COND (Siemens/m)	RESIDUAL (Siemens/m)
22.0000	0.0000	0.00000	2757.46	0.0000	0.00000
1.0000	34.6447	2.96269	5381.02	2.9627	-0.00001
4.5000	34.6250	3.26845	5581.53	3.2685	0.00001
14.9999	34.5835	4.24606	6178.31	4.2461	0.00003
18.5000	34.5748	4.58978	6374.58	4.5898	0.00000
24.0000	34.5653	5.14540	6679.36	5.1454	-0.00003
29.0000	34.5601	5.66506	6952.02	5.6650	-0.00002
32.5001	34.5572	6.03591	7140.05	6.0359	0.00002

f = INST FREQ / 1000.0

Conductivity = (g + hf² + if³ + jf⁴) / (1 + δt + εp) Siemens/meter

t = temperature[°C]; p = pressure[decibars]; δ = CTcor; ε = CPcor;

Residual = instrument conductivity - bath conductivity

Date, Slope Correction

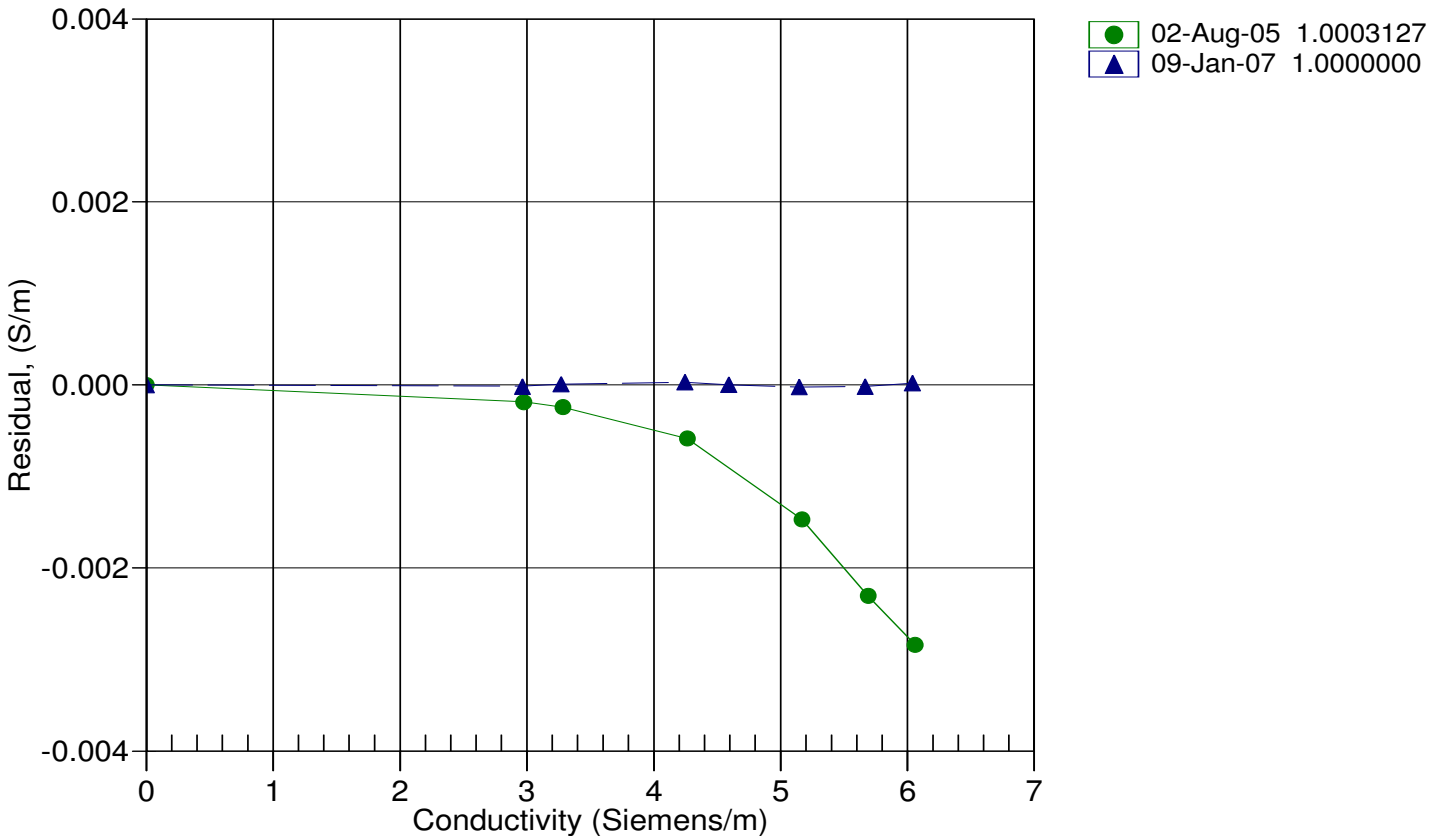

SEA-BIRD ELECTRONICS, INC.

1808 136th Place N.E., Bellevue, Washington, 98005 USA

Phone: (425) 643 - 9866 Fax (425) 643 - 9954 Email: seabird@seabird.com

SENSOR SERIAL NUMBER: 4677
CALIBRATION DATE: 04-Jan-07

SBE19plus PRESSURE CALIBRATION DATA
508 psia S/N 6135

COEFFICIENTS:

PA0 = 1.741331e-001	PTCA0 = 5.152023e+005
PA1 = 1.549722e-003	PTCA1 = 9.012761e+000
PA2 = 9.222321e-012	PTCA2 = -1.728316e-001
PTEMPA0 = -7.930081e+001	PTCB0 = 2.429287e+001
PTEMPA1 = 4.829264e+001	PTCB1 = -6.250000e-004
PTEMPA2 = -3.740742e-001	PTCB2 = 0.000000e+000

PRESSURE SPAN CALIBRATION

PRESSURE PSIA	INST OUTPUT	THERMISTOR OUTPUT	COMPUTED PRESSURE	ERROR %FSR
14.67	524663.0	2.1	14.67	-0.00
104.95	582845.0	2.1	104.93	-0.01
204.98	647223.0	2.1	204.86	-0.02
304.92	711614.0	2.1	304.90	-0.00
404.93	775925.0	2.1	404.89	-0.01
504.92	840208.0	2.1	504.91	-0.00
404.90	775962.0	2.1	404.95	0.01
304.89	711660.0	2.1	304.97	0.02
204.93	647285.0	2.1	204.96	0.01
104.93	582887.0	2.1	104.99	0.01
14.67	524664.0	2.1	14.67	-0.00

THERMAL CORRECTION

TEMP ITS90	THERMISTOR OUTPUT	INST OUTPUT
32.50	2.36	524972.58
29.00	2.28	524966.94
24.00	2.18	524974.66
18.50	2.06	524966.99
15.00	1.98	524954.54
4.50	1.76	524895.24
1.00	1.69	524865.65

TEMP (ITS90)	SPAN (mV)
-5.00	24.30
35.00	24.27

$$y = \text{thermistor output}; t = PTEMPA0 + PTEMPA1 * y + PTEMPA2 * y^2$$

$$x = \text{pressure output} - PTCA0 - PTCA1 * t - PTCA2 * t^2$$

$$n = x * PTCB0 / (PTCB0 + PTCB1 * t + PTCB2 * t^2)$$

$$\text{pressure (psia)} = PA0 + PA1 * n + PA2 * n^2$$

Date, Avg Delta P %FS

04-Jan-07 0.00

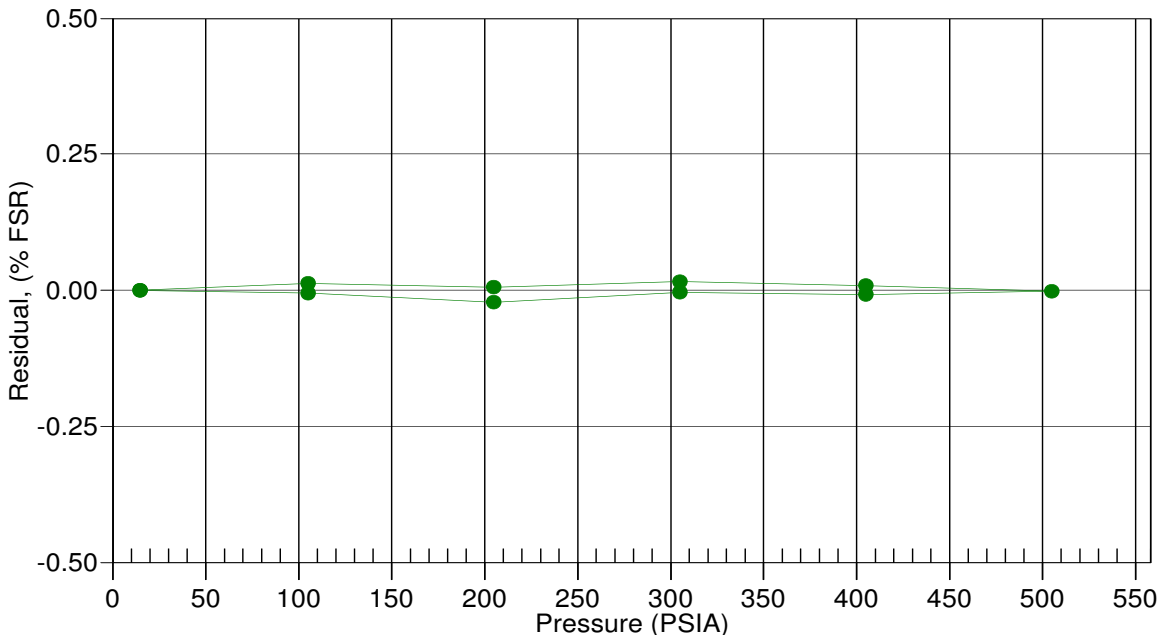

SEA-BIRD ELECTRONICS, INC.

1808 136th Place N.E., Bellevue, Washington, 98005 USA

Phone: (425) 643 - 9866 Fax (425) 643 - 9954 Email: seabird@seabird.com

SENSOR SERIAL NUMBER: 4677
 CALIBRATION DATE: 09-Jan-07

SBE19plus TEMPERATURE CALIBRATION DATA
 ITS-90 TEMPERATURE SCALE

ITS-90 COEFFICIENTS

a0 = 1.162054e-003
 a1 = 2.738619e-004
 a2 = -9.432152e-007
 a3 = 1.791934e-007

BATH TEMP (ITS-90)	INSTRUMENT OUTPUT(n)	INST TEMP (ITS-90)	RESIDUAL (ITS-90)
1.0000	693723.056	1.0001	0.0001
4.5000	620453.352	4.4998	-0.0002
14.9999	435193.141	15.0002	0.0003
18.5000	384587.141	18.4998	-0.0002
24.0000	315243.225	24.0000	0.0000
29.0000	261952.225	28.9998	-0.0002
32.5001	229534.817	32.5002	0.0001

$$MV = (n - 524288) / 1.6e+007$$

$$R = (MV * 2.900e+009 + 1.024e+008) / (2.048e+004 - MV * 2.0e+005)$$

$$\text{Temperature ITS-90} = 1 / \{ a_0 + a_1[\ln(R)] + a_2[\ln^2(R)] + a_3[\ln^3(R)] \} - 273.15 \text{ (}^\circ\text{C)}$$

$$\text{Residual} = \text{instrument temperature} - \text{bath temperature}$$

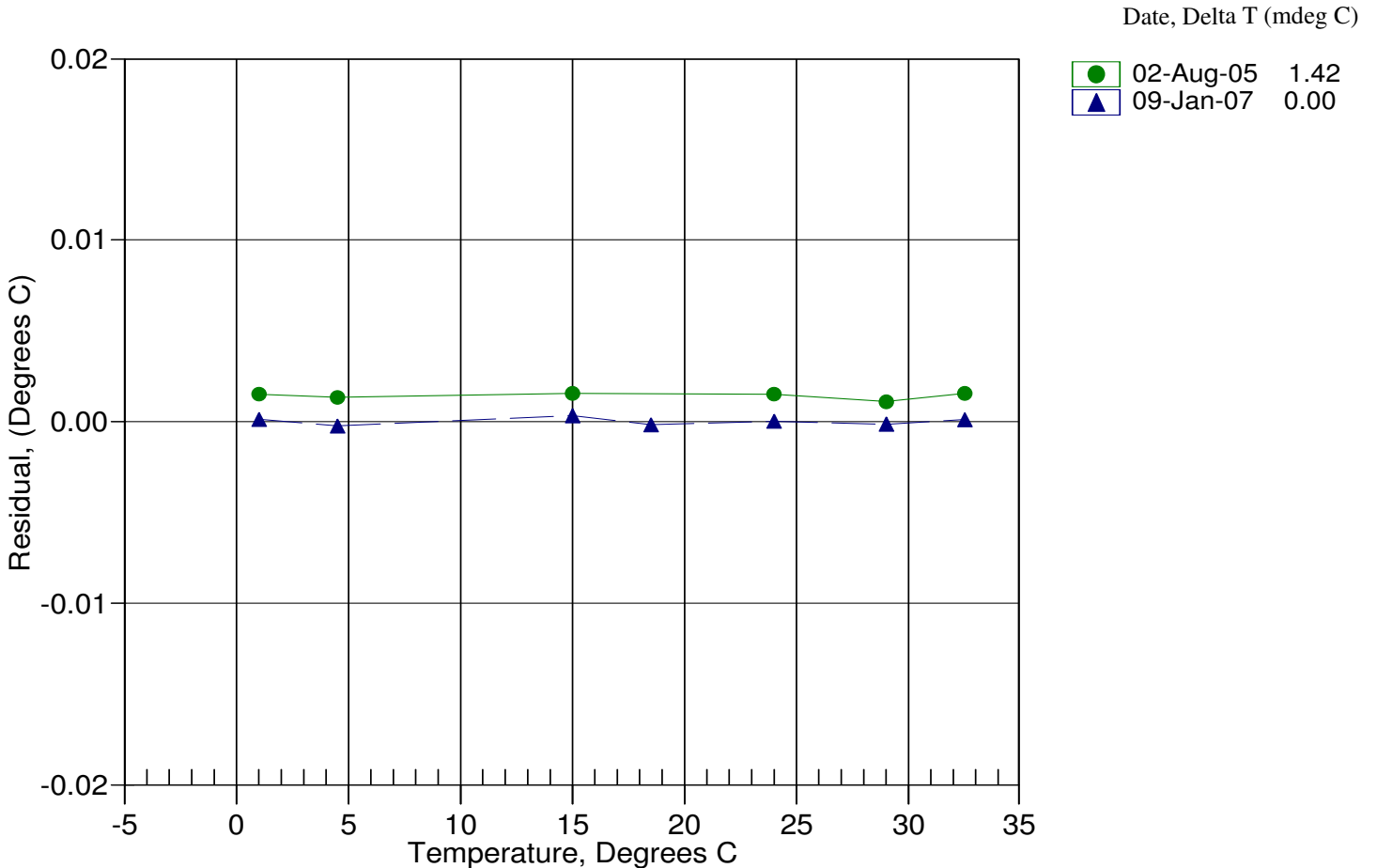



SEA-BIRD ELECTRONICS, INC.

1808 - 136th Place Northeast, Bellevue, Washington 98005 USA

Phone: (425) 643-9866 Fax: (425) 643-9954 www.seabird.com

Service
Report

RMA Number

44256

Customer Information:

Company	NOAA - NRT-1	Date	1/23/2007
Contact	Steve Brodet		
PO Number	TBD		

Serial Number	05M0684
Model Number	SBE 05T

Services Requested:

1. Evaluate/Repair Instrumentation.

Problems Found:

Services Performed:

1. Performed initial diagnostic evaluation.

Special Notes:



SEA-BIRD ELECTRONICS, INC.

1808 - 136th Place Northeast, Bellevue, Washington 98005 USA

Phone: (425) 643-9866 Fax: (425) 643-9954 www.seabird.com

Service
Report

RMA Number

44256

Customer Information:

Company	NOAA - NRT-1	Date	1/23/2007
Contact	Steve Brodet		
PO Number	TBD		

Serial Number	19P37217-4677
Model Number	SBE 19Plus

Services Requested:

1. Evaluate/Repair Instrumentation.
2. Perform Routine Calibration Service.

Problems Found:

--

Services Performed:

1. Performed initial diagnostic evaluation.
2. Upgraded firmware to most current revision (see special notes).*
3. Calibrated the pressure sensor.
4. Performed "Post Cruise" calibration of the temperature & conductivity sensors.
5. Performed complete system check and full diagnostic evaluation.

Special Notes:

* Updated the EPROM to version 1.6b.



SEA-BIRD ELECTRONICS, INC.

1808 - 136th Place Northeast, Bellevue, Washington 98005 USA

Phone: (425) 643-9866 Fax: (425) 643-9954 www.seabird.com

Temperature Calibration Report

Customer:	NOAA - NRT-1		
Job Number:	44256	Date of Report:	1/9/2007
Model Number	SBE 19Plus	Serial Number:	19P37217-4677

Temperature sensors are normally calibrated 'as received', without adjustments, allowing a determination sensor drift. If the calibration identifies a problem, then a second calibration is performed after work is completed. The 'as received' calibration is not performed if the sensor is damaged or non-functional, or by customer request.

An 'as received' calibration certificate is provided, listing coefficients to convert sensor frequency to temperature. Users must choose whether the 'as received' calibration or the previous calibration better represents the sensor condition during deployment. In SEASOFT enter the chosen coefficients using the program SEACON. The coefficient 'offset' allows a small correction for drift between calibrations (consult the SEASOFT manual). Calibration coefficients obtained after a repair apply only to subsequent data.

'AS RECEIVED CALIBRATION' Performed Not Performed

Date: Drift since last cal: Degrees Celsius/year

Comments:

'CALIBRATION AFTER REPAIR' Performed Not Performed

Date: Drift since Last cal: Degrees Celsius/year

Comments:

NRT7

Date:
Aug 05, 2005

Serial #:
SN:98351-080505

DIGIBAR CALIBRATION REPORT

version 1.0 (c) 2004

ODOM HYDROGRAPHIC SYSTEMS, Inc.

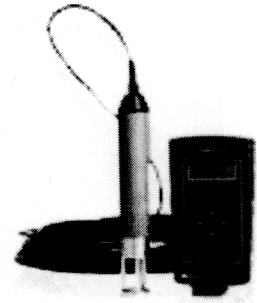

STANDARD DEL GROSSO H²O

TEMP	VELOCITY	MEASURED	RES_VEL	OBS-CAL	TEMP	VELOCITY	MEASURED	RES_VEL	OBS-CAL
FREQUENCY					FREQUENCY				
4.00	1421.62	5542.75	1421.68	0.06	17.50	1474.38	5743.90	1474.43	0.05
4.50	1423.90	5551.28	1423.91	0.01	18.00	1476.01	5750.29	1476.10	0.09
5.00	1426.15	5559.90	1426.17	0.02	18.50	1477.62	5756.37	1477.70	0.08
5.50	1428.38	5567.88	1428.27	-0.11	19.00	1479.21	5762.33	1479.26	0.05
6.00	1430.58	5576.13	1430.43	-0.15	19.50	1480.77	5768.23	1480.81	0.04
6.50	1432.75	5585.07	1432.77	0.02	20.00	1482.32	5774.42	1482.43	0.11
7.00	1434.90	5592.88	1434.82	-0.08	20.50	1483.84	5780.35	1483.99	0.14
7.50	1437.02	5601.20	1437.00	-0.02	21.00	1485.35	5785.90	1485.44	0.10
8.00	1439.12	5609.24	1439.11	0.00	21.50	1486.83	5791.72	1486.97	0.14
8.50	1441.19	5617.42	1441.26	0.07	22.00	1488.29	5797.10	1488.38	0.09
9.00	1443.23	5625.08	1443.27	0.03	22.50	1489.74	5802.69	1489.84	0.11
9.50	1445.25	5632.87	1445.31	0.06	23.00	1491.16	5808.02	1491.24	0.08
10.00	1447.25	5640.51	1447.31	0.06	23.50	1492.56	5813.29	1492.62	0.06
10.50	1449.22	5647.97	1449.27	0.05	24.00	1493.95	5818.91	1494.10	0.15
11.00	1451.17	5655.08	1451.13	-0.04	24.50	1495.32	5824.07	1495.45	0.14
11.50	1453.09	5662.46	1453.07	-0.03	25.00	1496.66	5829.18	1496.79	0.13
12.00	1454.99	5670.05	1455.06	0.07	25.50	1497.99	5834.29	1498.13	0.14
12.50	1456.87	5677.09	1456.91	0.03	26.00	1499.30	5839.08	1499.39	0.09
13.00	1458.72	5684.34	1458.81	0.08	26.50	1500.59	5843.82	1500.63	0.04
13.50	1460.55	5690.79	1460.50	-0.06	27.00	1501.86	5848.76	1501.93	0.07
14.00	1462.36	5698.01	1462.39	0.03	27.50	1503.11	5853.30	1503.12	0.01
14.50	1464.14	5704.80	1464.17	0.03	28.00	1504.35	5858.26	1504.42	0.07
15.00	1465.91	5711.42	1465.91	0.00	28.50	1505.56	5862.62	1505.56	0.00
15.50	1467.65	5718.18	1467.68	0.04	29.00	1506.76	5867.19	1506.76	0.00
16.00	1469.36	5724.96	1469.46	0.10	29.50	1507.94	5871.63	1507.92	-0.02
16.50	1471.06	5731.30	1471.12	0.07	30.00	1509.10	5876.34	1509.16	0.05
17.00	1472.73	5737.72	1472.81	0.08					

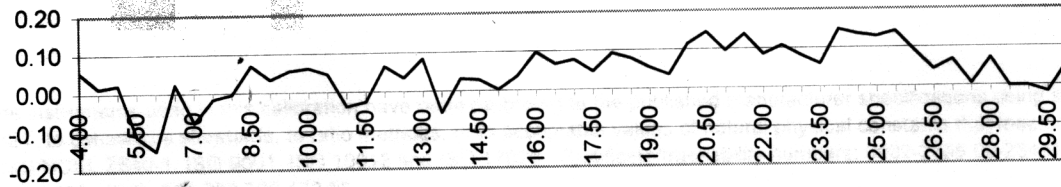

Odom Hydrographic Systems, Inc.

1450 SeaBoard Avenue, Baton Rouge, Louisiana 70810-6261, USA
Telephone: (225)-769-3051, Facsimile: (225)-766-5122
E-mail: email@odomhydrographic.com, HTTP: www.odomhydrographic.com

Date:
Aug 05, 2005

DIGIBAR CALIBRATION REPORT

version 1.0 (c) 2004

Serial #:
SN98351-080505

ODOM HYDROGRAPHIC SYSTEMS, Inc.

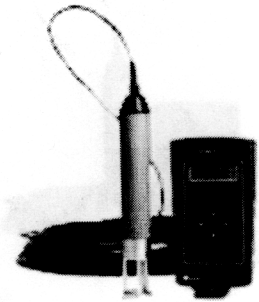

Burn these numbers to EPROM:

Gradient
Intercept

3357
319

Calibration Graph

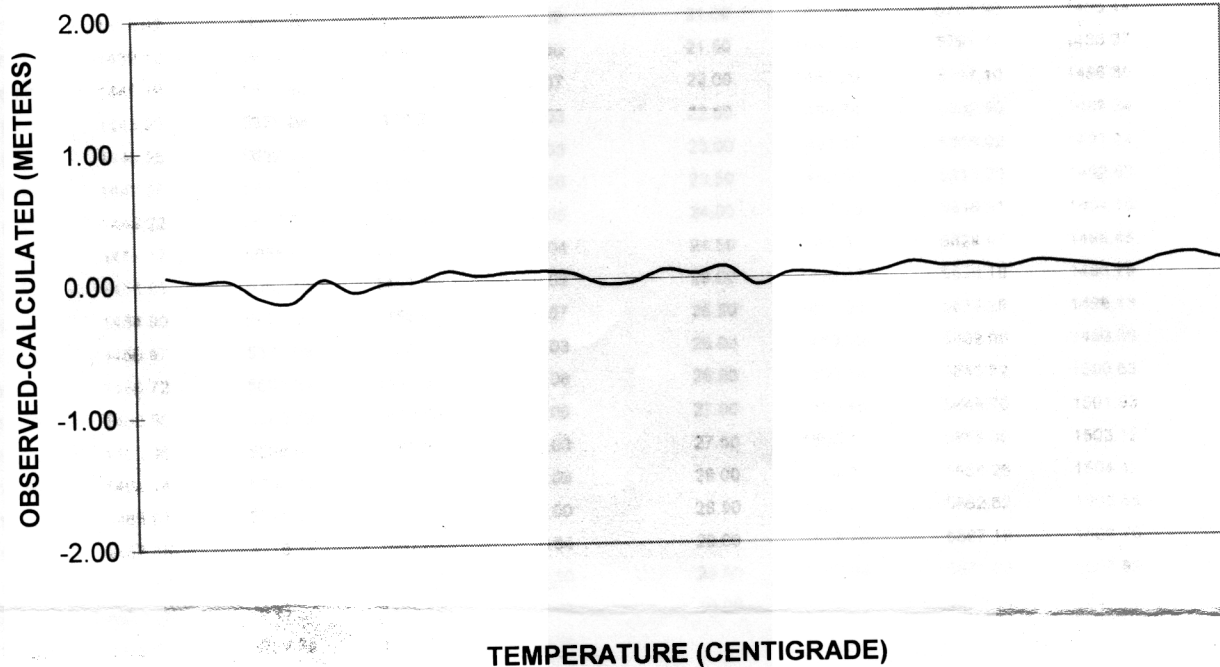

The instruments used in this calibration have been calibrated to the published manufacturer specifications using standards traceable to NIST, to consensus standards, to ratio methods, or to acceptable values of natural physical constants that meets the requirements of ANSI/NCSS Z540-1, ISO 9001, ISO 10012 and ISO 17025. Certificate/traceability numbers: 0002-2655.00-23491-001, 0002-2655.00-23491-002. ID#s:294,295,762,172,56



Odom Hydrographic Systems, Inc.

1450 SeaBoard Avenue, Baton Rouge, Louisiana 70810-6261, USA
Telephone: (225)-769-3051, Facsimile: (225)-766-5122
E-mail: email@odomhydrographic.com, HTTP: www.odomhydrographic.com

POS/MV Calibration Report

Field Unit: NRT7 s3004

SYSTEM INFORMATION

Vessel: NRT7 (s3004)
Date: 3/22/2007 Dn: 81
Personnel: LTJG Welton, PS Brodet, PS Gostnell, PS Turner
PCS Serial #: 2233
IP Address: 129.100.1.231
POS controller Version (Use Menu Help > About) POSView 3.3.2.2
POS Version (Use Menu View > Statistics) MV320 Ver4
GPS Receivers
Primary Receiver SN 60008125
Secondary Receiver SN 60001853

CALIBRATION AREA

Location: Patuxant River, MD (Solomons)
Approximate Position: Lat

D	M	S
38	18	50
76	26	42

 Lon
DGPS Beacon Station: Annapolis, MD
Frequency: 301 kHz

Satellite Constellation

(Use View > GPS Data)

Primary GPS (Port Antenna)

HDOP: 0.862
VDOP: 1.188

Satellites in Use: 9
2, 4, 5, 9, 12, 17, 20, 23, 28

PDOP 1.736 (Use View > GAMS Solution)

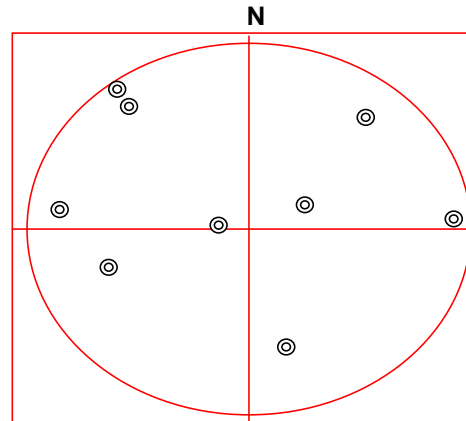

Note: Secondary GPS satellite constellation and number of satellites were exactly the same as the Primary GPS

POS/MV CONFIGURATION

Settings

Gams Parameter Setup

(Use Settings > Installation > GAMS Intallation)

User Entries, Pre-Calibration

1.559	Two Antenna Separation (m)
0.50	Heading Calibration Threshold
0	Heading Correction

Baseline Vector

-0.008	X Component (m)
1.559	YComponent (m)
0.017	Z Component (m)

Configuration Notes:

POS/MV CALIBRATION

Calibration Procedure:

(Refer to POS MV V3 Installation and Operation Guide, 4-25)

Start time: 13:21 UTC

End time: 13:26 UTC

Heading accuracy achieved for calibration: 0.031

Calibration Results:

Gams Parameter Setup

(Use Settings > Installation > GAMS Intallation)

POS/MV Post-Calibration Values

3.27	Two Antenna Separation (m)
0.500	Heading Calibration Threshold
0	Heading Correction

Baseline Vector

-0.042	X Component (m)
3.27	YComponent (m)
0.011	Z Component (m)

GAMS Status Online? yes

Save Settings? yes

Calibration Notes:

Save POS Settings on PC

(Use File > Store POS Settings on PC)

File Name: 2.22.2007.nvm

GENERAL GUIDANCE

The POS/MV uses a Right-Hand Orthogonal Reference System

The right-hand orthogonal system defines the following:

- The x-axis is in the fore-aft direction in the appropriate reference frame.
- The y-axis is perpendicular to the x-axis and points towards the right (starboard) side in the appropriate reference frame.
- The z-axis points downwards in the appropriate reference frame.

The POS/MV uses a Tate-Bryant Rotation Sequence

Apply the rotation in the following order to bring the two frames of reference into complete alignment:

- a) Heading rotation - apply a right-hand screw rotation θ_z about the z-axis to align one frame with the other.
- b) Pitch rotation - apply a right-hand screw rotation θ_y about the once-rotated y-axis to align one frame with the other.
- c) Roll rotation - apply a right-hand screw rotation θ_x about the twice-rotated x-axis to align one frame with the other.

SETTINGS (insert screen grabs)

Input/Output Ports (Use Settings > Input/Output Ports)

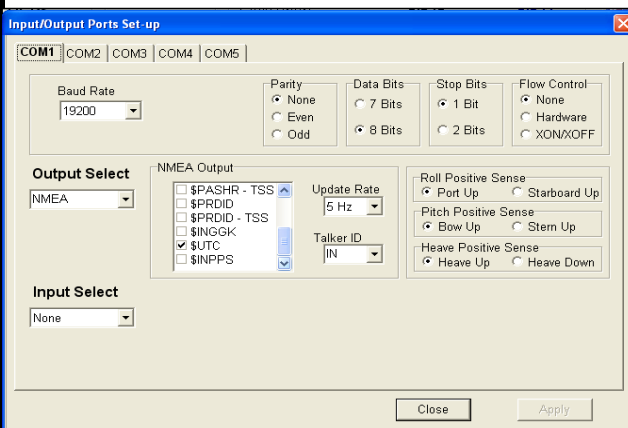

Input/Output Ports Set-up

COM1 | COM2 | COM3 | COM4 | COM5

Baud Rate: 19200

Parity: None Even Odd

Data Bits: 7 Bits 8 Bits

Stop Bits: 1 Bit 2 Bits

Flow Control: None Hardware XON/XOFF

Output Select: NMEA

NMEA Output:

- \$PASHR - TSS
- \$PRDID
- \$PRDID - TSS
- \$INGGK
- \$UTC
- \$INPPS

Update Rate: 5 Hz

Talker ID: IN

Roll Positive Sense: Port Up Starboard Up

Pitch Positive Sense: Bow Up Stern Up

Heave Positive Sense: Heave Up Heave Down

Input Select: None

Close Apply

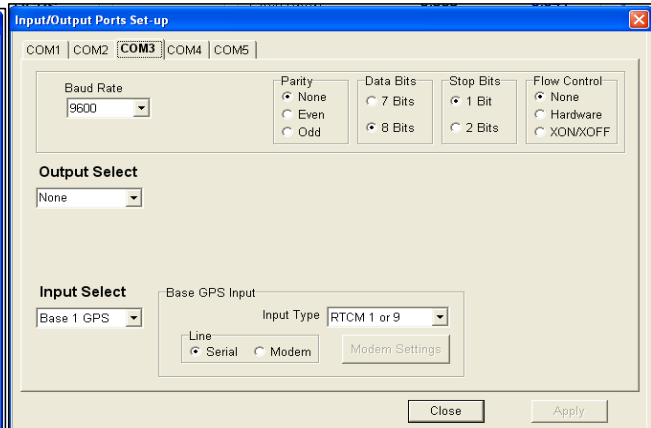

Input/Output Ports Set-up

COM1 | COM2 | COM3 | COM4 | COM5

Baud Rate: 9600

Parity: None Even Odd

Data Bits: 7 Bits 8 Bits

Stop Bits: 1 Bit 2 Bits

Flow Control: None Hardware XON/XOFF

Output Select: None

Input Select: Base 1 GPS

Base GPS Input: Input Type: RTCM 1 or 9

Line: Serial Modem

Close Apply

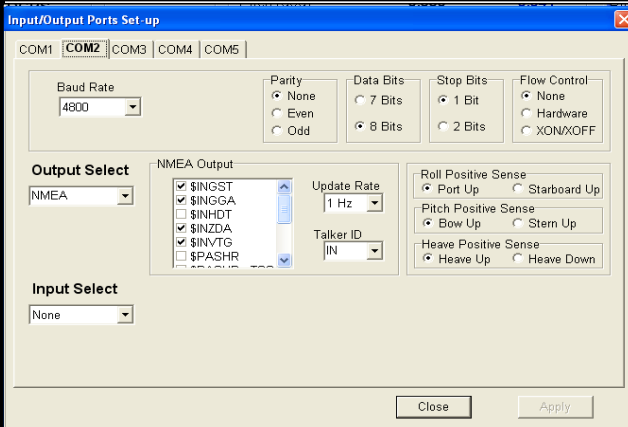

Input/Output Ports Set-up

COM1 | COM2 | COM3 | COM4 | COM5

Baud Rate: 4800

Parity: None Even Odd

Data Bits: 7 Bits 8 Bits

Stop Bits: 1 Bit 2 Bits

Flow Control: None Hardware XON/XOFF

Output Select: NMEA

NMEA Output:

- \$INGST
- \$INGGA
- \$INHDT
- \$INZDA
- \$INVTG
- \$PASHR

Update Rate: 1 Hz

Talker ID: IN

Roll Positive Sense: Port Up Starboard Up

Pitch Positive Sense: Bow Up Stern Up

Heave Positive Sense: Heave Up Heave Down

Input Select: None

Close Apply

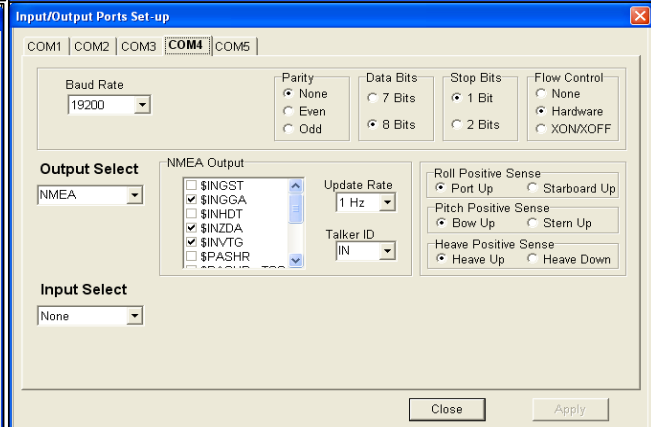

Input/Output Ports Set-up

COM1 | COM2 | COM3 | COM4 | COM5

Baud Rate: 19200

Parity: None Even Odd

Data Bits: 7 Bits 8 Bits

Stop Bits: 1 Bit 2 Bits

Flow Control: None Hardware XON/XOFF

Output Select: NMEA

NMEA Output:

- \$INGST
- \$INGGA
- \$INHDT
- \$INZDA
- \$INVTG
- \$PASHR

Update Rate: 1 Hz

Talker ID: IN

Roll Positive Sense: Port Up Starboard Up

Pitch Positive Sense: Bow Up Stern Up

Heave Positive Sense: Heave Up Heave Down

Input Select: None

Close Apply

NOTE:

Heave Filter (Use Settings > Heave)

Heave Filter

Z Altitude

Heave Filter

Heave Bandwidth (sec) 10.000

Damping Ratio 0.707

Ok Close Apply

Heave Filter (Use Settings > Heave)

Events (Use Settings > Events)

Events

Event 1

Positive Edge Trigger

Negative Edge Trigger

Event 2

Positive Edge Trigger

Negative Edge Trigger

Ok Close Apply

Time Sync (Use Settings > Time Sync)

Installation (Use Settings > Installation)

Lever Arms & Mounting Angles

Lever Arms & Mounting Angles | Sensor Mounting | Tags, Multipath & AutoStart | View

Ref. to IMU Lever Arm

X (m) 0.346

Y (m) -0.002

Z (m) 0.137

IMU Frame w.r.t. Ref. Frame

X (deg) 0.000

Y (deg) -1.470

Z (deg) 0.000

Ref. to Primary GPS Lever Arm

X (m) 2.181

Y (m) -1.621

Z (m) -3.799

Ref. to Vessel Lever Arm

X (m) 0.000

Y (m) 0.000

Z (m) 0.000

Notes:

1. Ref. = Reference
2. w.r.t. = With Respect To
3. Reference Frame and Vessel Frame are co-aligned

Ref. to Centre of Rotation Lever Arm

X (m) 0.000

Y (m) 0.000

Z (m) 0.000

Ok Close Apply View

In Navigation Mode, to change parameters go to Standby Mode!

Tags, Multipath and Auto Start (Use Settings > Installation > Tags, Multipath and Auto Start)

Lever Arms & Mounting Angles [Close]

Lever Arms & Mounting Angles | Sensor Mounting | Tags, Multipath & AutoStart

Time Tag 1

- POS Time
- GPS Time
- UTC Time

Multipath

- Low
- Medium
- High

Time Tag 2

- POS Time
- GPS Time
- UTC Time
- User Time

AutoStart

- Disabled
- Enabled

Ok Close Apply View

In Navigation Mode , to change parameters go to Standby Mode !

Sensor Mounting (Use Settings > Installation > Sensor Mounting)

Lever Arms & Mounting Angles [Close]

Lever Arms & Mounting Angles | Sensor Mounting | Tags, Multipath & AutoStart

Ref. to Aux. 1 Gps Lever Arm

X (m)	0.000
Y (m)	0.000
Z (m)	0.000

Ref. to Aux. 2 GPS Lever Arm

X (m)	0.000
Y (m)	0.000
Z (m)	0.000

Ref. to Sensor 1 Lever Arm

X (m)	0.000
Y (m)	0.000
Z (m)	0.000

Sensor 1 Frame w.r.t. Ref. Frame

X (deg)	0.000
Y (deg)	0.000
Z (deg)	0.000

Ref. to Sensor 2 Lever Arm

X (m)	0.000
Y (m)	0.000
Z (m)	0.000

Sensor 2 Frame w.r.t. Ref. Frame

X (deg)	0.000
Y (deg)	0.000
Z (deg)	0.000

Ok Close Apply

User Parameter Accuracy (Use Settings > Installation > User Accuracy)

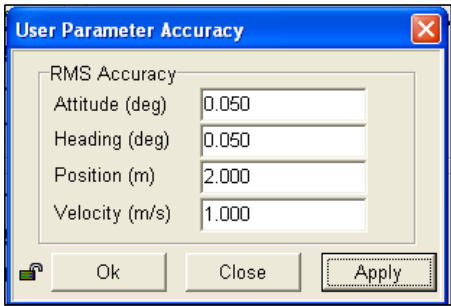

User Parameter Accuracy

RMS Accuracy

Attitude (deg)

Heading (deg)

Position (m)

Velocity (m/s)

Frame Control (Use Tools > Config)

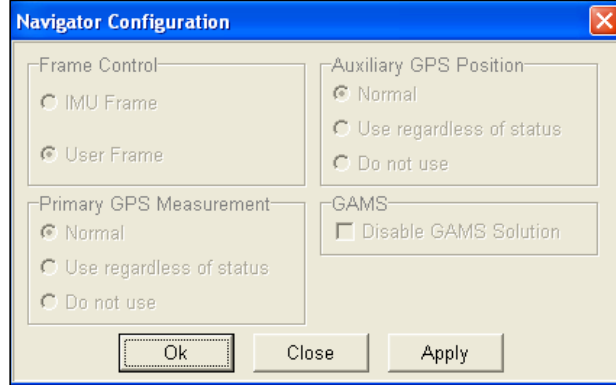

Navigator Configuration

Frame Control

IMU Frame

User Frame

Auxiliary GPS Position

Normal

Use regardless of status

Do not use

Primary GPS Measurement

Normal

Use regardless of status

Do not use

GAMS

Disable GAMS Solution

GPS Receiver Configuration (Use Settings > Installation > GPS Receiver Configuration)

Primary GPS Receiver

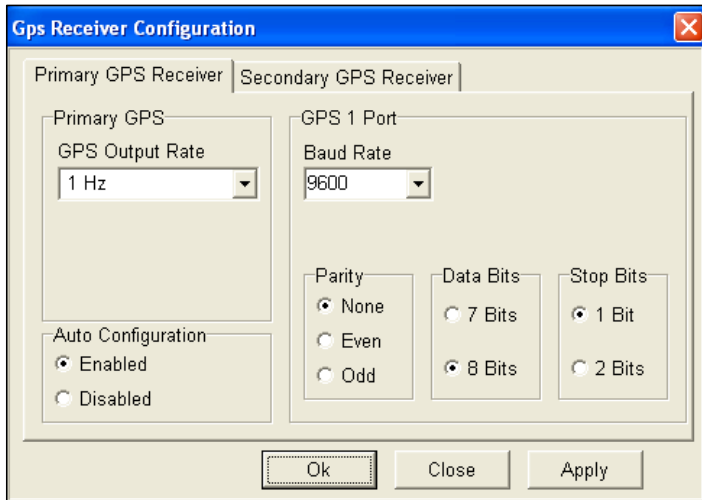

Gps Receiver Configuration

Primary GPS Receiver | Secondary GPS Receiver

Primary GPS

GPS Output Rate

GPS 1 Port

Baud Rate

Parity

None

Even

Odd

Data Bits

7 Bits

8 Bits

Stop Bits

1 Bit

2 Bits

Auto Configuration

Enabled

Disabled

Secondary GPS Receiver

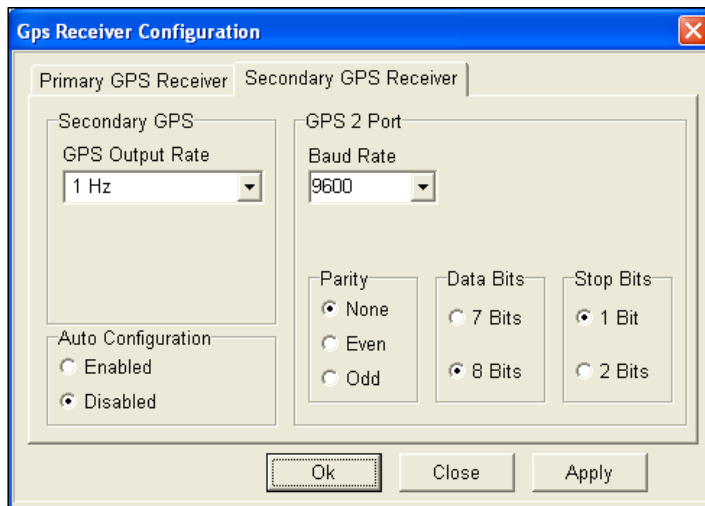

Gps Receiver Configuration

Primary GPS Receiver | Secondary GPS Receiver

Secondary GPS

GPS Output Rate

GPS 2 Port

Baud Rate

Parity

None

Even

Odd

Data Bits

7 Bits

8 Bits

Stop Bits

1 Bit

2 Bits

Auto Configuration

Enabled

Disabled

Appendix V

HYDROGRAPHIC SYSTEMS READINESS REVIEW MEMO

July 27, 2007

MEMORANDUM FOR: CDR Gerd Glang, NOAA
Chief, Hydrographic Surveys Division

LCDR Lawrence Krepp, NOAA
Chief, Navigation Response Branch

Robert Downs
Acting Chief, Hydrographic Systems and Technology
Programs

LCDR Shepard Smith, NOAA
Chief, Atlantic Hydrographic Branch

FROM: LTJG Briana Welton, NOAA
Mid-Atlantic Region Team Leader, SPOT

SUBJECT: Special Projects Operations Team (SPOT) Hydrographic
Systems Status Summary

The hydrographic systems of the Special Projects Operations Team (SPOT) were reviewed in accordance with the Office of Coast Survey Field Procedures Manual (FPM) Hydrographic Systems Readiness Review procedures on March 29, 2007. The review process took place at Calvert Marina in Solomons, MD, and was conducted by a Hydrographic Systems Review Team comprised of the following people:

LTJG Briana Welton, Mid-Atlantic Region Team Leader
Caleb Gostnell, Physical Scientist, HSD Ops
Paul Turner, Physical Scientist, HSD Ops
Steve Brodet, Physical Scientist, HSTP

The Review Team's findings are summarized in this memorandum and reflect the condition of the SPOT's hydrographic systems on the review date. These findings have been divided into three categories of deficiencies:

CATEGORY 1 – These deficiencies indicate the failure or absence of vital equipment or preparations of systems essential to acquisition and/or processing of hydrographic data. The

HYDROGRAPHIC SYSTEMS READINESS REVIEW MEMO

vessel will be required to cease or limit hydrographic survey operations due to the following deficiencies:

1. The Special Projects Operations Team has a requirement for portable office space and at least two data processing computers with accompanying software. The office trailer is unequipped for mobile assignments and the unit has no processing machines. Currently the Team Leader is using Atlantic Hydrographic Branch office space and a laptop to process existing data, but the lack of dedicated processing machines makes efficient data manipulation and delivery nearly impossible.

CATEGORY 2 – These deficiencies indicate noncompliance with established policies, directives, instructions, or accepted hydrographic practice not addressed under Category 1. The following deficiencies shall be corrected in as timely a manner as funding, time, and/or professional assistance permit:

1. The vessel has only one mounting arm from which to deploy any one of the vessel's three sonar systems: Reson 8125 multibeam echosounder (MBES), Light Weight Klein 5000 side scan sonar (SSS), and Benthos C3D interferometric sonar. A patch test must be performed each time one of these sonar systems is newly mounted before conducting hydrographic survey operations.
2. The port-side mounting arm was removed and the starboard side mounting arm was modified since the last NGS static offset survey. Since neither the length of the starboard arm or position of the cupped receptacle for the arm were altered, the surveyed benchmark stamp on the top of the arm is assumed to be the same as it was prior to modification. The offsets within the vessel frame of reference between the acoustic phase center of each sonar system and the benchmark on the top of the mounting arm have been manually measured with a steel tape. These manually measured offsets are used in the respective Caris HIPS/SIPS hydrographic vessel files (HVF). Resurvey of the mounting arm will be performed when possible.
3. A lead line comparison between the Reson 8125 multibeam, the Odom CV singlebeam, and the Benthos C3D interferometric sonar has never been performed. This comparison will be performed as soon as time and staffing allows.
4. Settlement and squat measurements have never been performed on this vessel. The current dynamic draft tables used in the system HVFs are from NRT 5 (s3002), a vessel of the same make and model. Settlement and squat measurements will be determined for this vessel as soon as time and staffing allows.

HYDROGRAPHIC SYSTEMS READINESS REVIEW MEMO

5. Isis 6.0 is currently being used for Reson 8125 and light weight Klein 5000 data acquisition. The software will be updated to the most recent version of Isis 7.0 when time and staffing allows.

CATEGORY 3 – items are associated with observations during the course of the review which merit consideration for corrective actions. These observations are included for review and dialogue related to potential problem areas and hydrographic operational efficiency. It is important to assure that resources (funds, skills, and time) are available at the operating level in order to meet the needs identified in this report and to sustain the efficient operation, upkeep, and repair of the field unit's hydrographic systems.

1. The computer on which Hypack Max is used for navigation and singlebeam data acquisition exhibited serious boot errors on the date of review. The computer was sent to the Office of Coast Survey's Hydrographic Support and Technology Program for analysis. A new hard drive and an updated operating system were installed to remedy the operating system boot problem. Since the update, the computer operates slower than expected for unidentified reasons.
2. The Digibar surface sound-velocimeter operates on battery power only, requiring weekly and/or daily battery renewal. Until a 12-volt power supply can be added to the Digibar, spare batteries must be carried aboard the vessel.
3. The vessel does not have a bottom-sampler, preventing the acquisition of bottom samples. Acquisition of a bottom-sampler should be considered.