

**U.S. DEPARTMENT OF COMMERCE
NATIONAL OCEANIC AND ATMOSPHERIC ADMINISTRATION
NATIONAL OCEAN SERVICE**

Data Acquisition & Processing Report

Type of Survey Hydrographic
Project No. 2010 Field Season
Registry No. _____

LOCALITY

State Washington and Alaska
General Locality _____

CAPT David O. Neander, NOAA

CHIEF OF PARTY

LIBRARY & ARCHIVES

DATE _____



Fairweather 2010
Data Acquisition & Processing Report



A. INTRODUCTION..... A-1

B. EQUIPMENT B-1

1.0 Hardware..... B-1

1.1 Hardware Systems Inventory B-1

1.2 Echo Sounding Equipment..... B-1

1.2.1 Reson 7111 Multibeam Echosounder (MBES) B-1

1.2.2 Reson 8160 Multibeam Echosounder (MBES) B-2

1.2.3 Reson 7125SV Multibeam Echosounder (MBES) B-3

1.2.4 Klein 5000 Side Scan Sonar (SSS)..... B-3

1.3 Manual Sounding Equipment..... B-5

1.3.1 Lead Lines B-5

1.4 Positioning, Heading, and Attitude Equipment..... B-5

1.4.1 Applanix Positioning and Orientation System for Marine Vehicles (POS/MV). B-5

1.4.2 POS/MV GAMS Calibration..... B-6

1.4.3 DGPS Receivers B-7

1.4.4 Trimble Backpack..... B-7

1.4.5 Hand-held Laser B-8

1.5 Sound Speed Equipment B-9

1.5.1 Sound Speed Profiles..... B-9

1.5.1.1 SBE 19plus SEACAT Profiler..... B-9

1.5.1.2 Moving Vessel Profiler 200 B-9

1.5.2 Surface Sound Speed..... B-10

1.5.2.1 Reson Sound Velocity Probe (SVP 70) B-10

1.5.2.2 Reson Sound Velocity Probe (SVP 71) B-11

1.6 Vertical Control Equipment B-12

1.6.1 Water Level Gauges B-12

1.6.2 Leveling Equipment B-12

1.7 Horizontal Control Equipment..... B-13

2.0 Software..... B-13

2.1 Software Systems Inventory..... B-13

2.2 Data Acquisition Software B-13

2.2.1 Hypack® Hysweep..... B-13

2.2.2 CARIS Notebook..... B-14

2.2.3 Klein SonarPro B-15

2.2.4 Applanix POSView B-15

2.3 Data Processing Software..... B-15

2.3.1 CARIS B-15

2.3.2 Fledermaus™ B-15

2.3.3 Geocoder..... B-16

Process Owner: **Survey**
Updated: 8/13/2010

Approval: CO *Fairweather*
Approval Date: **2010**

| | | |
|------------|---|-------------|
| 2.3.4 | Applanix POSPac MMS and POSGNSS | B-16 |
| 2.3.5 | Velocipy..... | B-16 |
| 2.3.6 | Pydro..... | B-16 |
| 3.0 | Vessels..... | B-17 |
| 3.1 | Vessel Inventory..... | B-17 |
| 3.2 | Noise Analysis..... | B-17 |
| 4.0 | Data Acquisition | B-17 |
| 4.1 | Horizontal Control..... | B-17 |
| 4.2 | Multibeam Echosounder Acquisition and Monitoring Procedures | B-18 |
| 4.3 | Shoreline/Feature Verification | B-18 |
| 4.4 | Bottom Samples | B-19 |
| C. | QUALITY CONTROL..... | C-19 |
| 1.0 | Uncertainty Modeling..... | C-19 |
| 2.0 | Data Processing..... | C-20 |
| 2.1 | Multibeam Echosounder Data Processing..... | C-20 |
| 2.2 | Shoreline/Feature Data Processing..... | C-22 |
| 3.0 | Data Review..... | C-23 |
| D. | CORRECTIONS TO ECHO SOUNDINGS | D-23 |
| 1.0 | Vessel HVFs..... | D-23 |
| 2.0 | Vessel Offsets..... | D-23 |
| 3.0 | Static and Dynamic Draft | D-25 |
| 4.0 | Patch Tests..... | D-26 |
| 5.0 | Attitude and Kinematic Data..... | D-27 |
| 5.1 | TrueHeave™ | D-27 |
| 5.2 | Post Processed Kinematic Data..... | D-27 |
| 6.0 | Sound Speed | D-28 |
| 7.0 | Water Level | D-29 |

APPENDICES

- Appendix I System Tracking
- Appendix II Vessel Reports, Offsets, and Diagrams
- Appendix III Total Propagated Uncertainty
- Appendix IV Correspondence



A. INTRODUCTION

This Data Acquisition and Processing Report outlines the acquisition and processing procedures used for Hydrographic projects surveyed in 2010 by NOAA Ship *Fairweather*. Survey specific details will be listed in Descriptive Reports as needed. Unless otherwise noted, the acquisition and processing procedures used and deliverables produced are in accordance with the NOAA *Hydrographic Survey Specifications and Deliverables Manual (HSSD) April 2010*, the *Field Procedures Manual (FPM), April 2010*, and all active Hydrographic Surveys Technical Directives (HTD).

Any additions and changes to the following will be included with the individual Descriptive Reports or by submission of an addendum.

B. EQUIPMENT

Detailed descriptions of the equipment and systems, including hardware and software, used for bathymetric data acquisition, horizontal and vertical control operations, shoreline acquisition, and processing are listed below.

1.0 Hardware

The hardware listed in this section is used throughout the 2010 field season.

1.1 Hardware Systems Inventory

Detailed hardware information, including installation dates and serial numbers, is included in Appendix I of this report. Manufacturer's product specifications are maintained with reference documentation on board *Fairweather*.

1.2 Echo Sounding Equipment

1.2.1 Reson 7111 Multibeam Echosounder (MBES)

Fairweather is equipped with a Reson 7111 MBES. The system was upgraded from a Reson 8111 in October 2009, which involved replacing the dry end transceiver and processor units but leaving the wet end hull-mounted projector and receiver intact. The Reson 7111 is a 100 kHz multibeam system with swath coverage of 150°. The swath is made up of 301 discrete equidistant beams with an along-track and across-track beamwidth of 0.5°. It has a specified depth range of 3 to 1200 meters, though the typical operational depth range of the Reson 7111 on *Fairweather* is 20 to 300 meters. No calibration information was provided by the manufacturer for the system.

The Reson 7111 is hull-mounted within a reinforced projection that extends 27 inches below the keel. It is located 39.5" starboard of the centerline at approximately frame 29 (see Figure 1 & Figure 2).

Various hardware and software issues have been identified with the Reson 7111 system since the initial upgrade in October 2009 which include: CARIS uncertainty modeling, real-time pitch application, several transceiver hardware failures, and bottom detection algorithms; all of which affect the system's performance capabilities and use. While *Fairweather* continues to work with Reson, NOAA, and academia to understand the cause of the issues and to resolve them, various data acquisition and processing modifications may be made based upon the current status of the Reson 7111 system. Updated information about the Reson 7111 issue is provided in the Project Correspondence folder submitted with each survey.

1.2.2 Reson 8160 Multibeam Echosounder (MBES)

Fairweather is equipped with a Reson SeaBat 8160 MBES with the snippet option. The Reson 8160 is a 50 kHz multibeam system with a swath coverage of greater than 4x water depth. Each swath is made up of 126 discrete beams with an along-track and across-track beamwidth of 1.5°. It has a specified depth range of 10 to 3000 meters, though the typical operational depth range of the Reson 8160 on *Fairweather* is 300 to 1000 meters. No calibration information was provided by the manufacturer of the system.

The 8160 is hull-mounted within a reinforced projection that extends 13.6 inches below the keel. It is located 54 inches port of the centerline at approximately frame 29 (see Figure 3 & Figure 4).

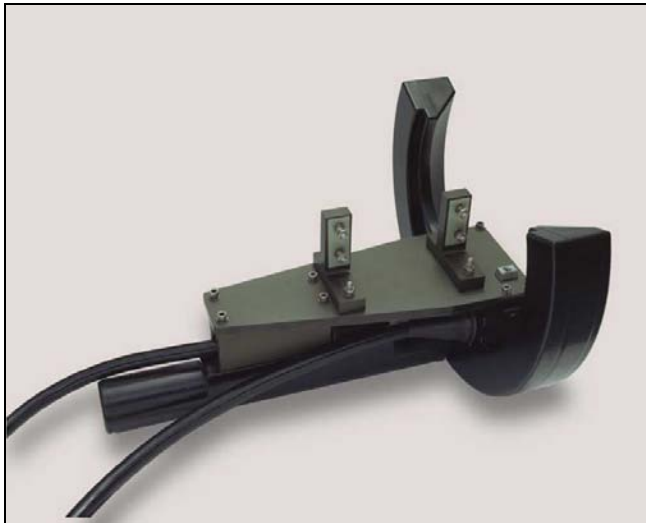

Figure 1: RESON SeaBat 7111 MBES



Figure 2: Installed on *Fairweather*



Figure 3: Reson SeaBat 8160



Figure 4: Installed on *Fairweather*

1.2.3 Reson 7125SV Multibeam Echosounder (MBES)

Survey launches 2805, 2806, 2807 and 2808 are each equipped with a dual frequency Reson 7125SV MBES. The Reson 7125SV has both low frequency (200kHz) and a high frequency (400kHz) head with a swath coverage of 128°. The swath is made up of 256 discrete beams for 200 kHz and 512 discrete beams for 400 kHz. The typical operational depth ranges for the Reson 7125SV operating at 200kHz is 3 to 400 meters and 3 to 100 meters operating with the 400kHz system. No calibration information was provided by the manufacturer for the system. Each system is hull mounted along the centerline (see Figure 5).



Figure 5: Reson 7125SV on a *Fairweather* Launch

1.2.4 Klein 5000 Side Scan Sonar (SSS)

The Klein Series 5000 Sonar System consists of a side scan sonar instrument-mounted towfish, a Transceiver and Processing Unit (TPU), and Windows-based computer for display and control, along with a tow cable and various interconnect cables. The 5000 series operates at a

nominal frequency of 500 kHz (455 kHz actual) and has a depth rating to 200 meters. It is software driven on a PC platform employing Klein's SonarPro™ software. Files are logged in SDF format and converted into CARIS SIPS HDCS file format for post processing.

Testing of dual Klein 5000 SSS and Reson 7125 MBES data acquisition occurred in March 2010. The report of the test plan and results are located in Appendix II, *2010 - FA Dual SSS & MBES Acquisition.pdf*. A supplemental wiring diagram for when the launches are outfitted with Klein 5000 SSS is maintained aboard *Fairweather*. Reson 7125 MBES data acquired simultaneously with the SSS data is filtered down to 50-degrees on the side on which the SSS is mounted.

The towfish can be used in one of two configurations, hull-mounted on any one of *Fairweather's* launches (Figure 6) or towed from *Fairweather* (Figure 7). In the hull-mounted configuration, the towfish is bolted to a sled on the bottom of the launch. The sled is situated to port of the keel and is approximately centered fore and aft. In the towed configuration the towfish is fitted with a K-wing depressor and affixed to armored coaxial cable for deployment from *Fairweather's* A-frame. The amount of tow cable being used is manually entered into SonarPro™ for towfish layback calculation. If in a towed configuration, full sidescan calibration and documentation will be conducted prior to data collection and system utilization.

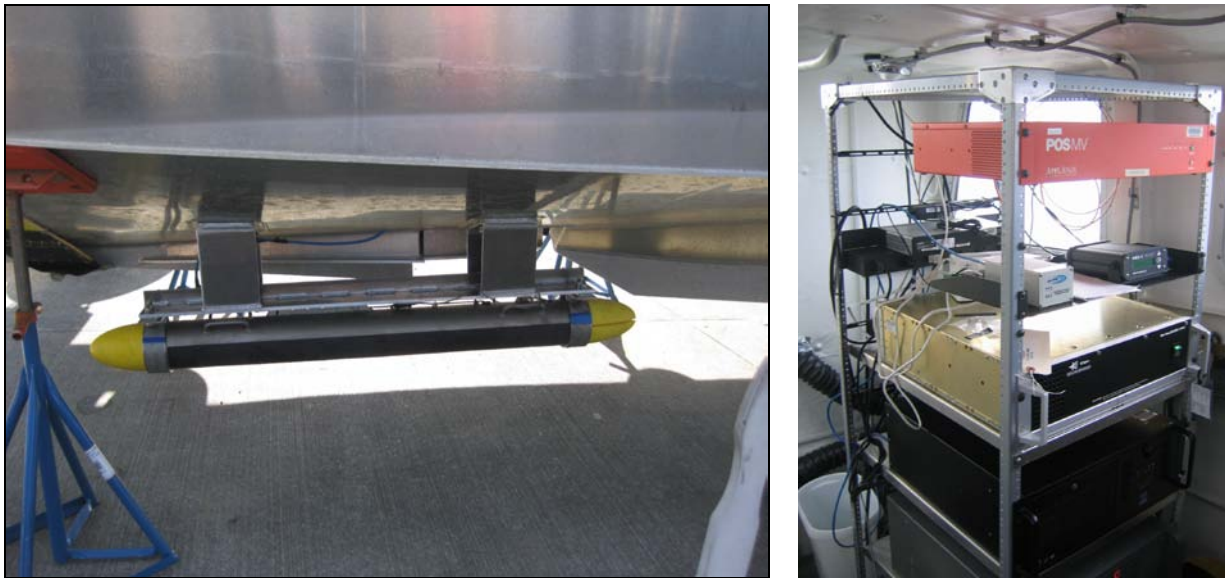

Figure 6: Hull-Mounted Klein 5000 Side Scan Sonar on *Fairweather* Launch



Figure 7: Towed Klein 5000 Side Scan Sonar on Fairweather

1.3 Manual Sounding Equipment

1.3.1 Lead Lines

Vessels are equipped with a lead line when appropriate. Lead lines are used for depth measurements near shore over submerged shoals and for echosounder depth comparisons.

Leadlines were created, measured and calibrated according to Section 1.5.3 of the *FPM* with the exception that the lines were calibrated to the meter instead of decimeter. Calibration was performed during March 24, 2010, and documentation is maintained aboard *Fairweather*.

1.4 Positioning, Heading, and Attitude Equipment

1.4.1 Applanix Positioning and Orientation System for Marine Vehicles (POS/MV)

Fairweather and her launches are each equipped with a POS/MV 320 V4, configured with TrueHeave™. The POS/MV calculates position, heading, attitude, and vertical displacement (heave) of a vessel. It consists of a rack mounted POS Computer System (PCS), a strap down IMU-200 Inertial Measurement Unit (IMU), and two GNSS antennas corresponding to GNSS receivers in the PCS. *Fairweather* (S220) and launches 2805, 2807, and 2808 are equipped with new Zephyr II GNSS antennas. Launch 2806 is equipped with used Zephyr I GNSS antennas. *Fairweather* (S220) and launch 2805 are equipped with BD960 PCS antenna receiver cards, and launches 2806, 2807, and 2808 are equipped with BD950 PCS antenna receiver cards. The port side antenna is designated as the primary receiver, and the starboard side antenna is the secondary receiver (see Figure 8). The POS/MV firmware version 4.22 and

the controller software version 4.3.4.0 are currently the installed versions utilized. Differential correctors are supplied to the *Fairweather's* POS MV by a CSI wireless MBX-3S Automatic Differential GPS receiver and to launches 2805, 2806, 2807 and 2808 by a Hemisphere GPS MBX-4 Automatic Differential GPS receiver.

For all multibeam systems aboard *Fairweather* and her launches, timing between the sonar swath, position, heading and attitude information was synchronized by utilizing the proprietary UTC string from POS/MV. A timing string is sent from the POS/MV to the Reson topside unit via serial connection and to the Hypack acquisition computer via ethernet.

POS/MV controller software was used to monitor position accuracy and quality during data acquisition. This ensured that positioning accuracy requirements are met, as outlined in section 3.2.1 of the *HSSD*. The POS/MV controller software provides clear visual indications whenever accuracy thresholds are exceeded.

On May 2, 2010, two new Zephyr II GNSS POS/MV antennas were installed aboard *Fairweather*, replacing the existing Zephyr I antennas mounted on the ship. The vertical coordinate for the 'primary antenna to ref entry' in the POS/MV was changed in the POS/MV controller software by roughly 2cm to account for the new antenna offsets and is incorporated into the *S220 Offsets & Measurements* spreadsheet included in Appendix II. The Nav-to-Transducer TPU values in the Reson 7111 and 8160 hvfs were also updated as well as the TPU spreadsheet in Appendix III to account for the antenna change. The serial numbers of the two new antennas are captured in the Hardware Inventory spreadsheet in Appendix I.

1.4.2 POS/MV GAMS Calibration

In the spring of 2010, GNSS Azimuth Measurement System (GAMS) calibrations were performed on each of *Fairweather's* five POS/MV units mounted to launches 2805, 2806, 2807, 2808, and *Fairweather* (S220). The GAMS calibration procedure was conducted in accordance with instructions in chapter 4 of the *POS/MV V4 Installation and Operation Guide*, 2005. Results and calibration reports are maintained with reference documentation aboard *Fairweather*. Actual calibration dates are listed in the Hardware Inventory included in Appendix I.



Figure 8: POS GNSS Antennas

1.4.3 DGPS Receivers

Fairweather is equipped with a commercial grade CSI Wireless MBX-3S DGPS Receiver on *Fairweather* (S220) and Hemisphere GPS MBX-4 DGPS receivers on launches 2805, 2806, 2807 and 2808 that are used to correct the POS/MV GPS positions used during real-time MBES data acquisition. The DGPS receivers are configured in manual mode to allow reception of only one U.S. Coast Guard (USCG) differential GPS beacon station.

Differential GPS (DGPS) is the primary method of real-time positioning. The individual descriptive reports for each survey list the U.S. Coast Guard beacon sites and frequencies used for differential corrections utilized during hydrographic surveying.

When *Fairweather* operates in remote areas outside of DGPS range such as the Bering Sea, *Fairweather* is equipped with a NavCom receiver for utilizing the subscription-based StarFire Network, which is a global satellite based augmentation system capable of real-time decimeter position accuracy. None of *Fairweather's* launches are equipped with NavCom receivers. Launches run in course acquisition mode (CA) during real-time data acquisition, which typically results in 2-3 meter horizontal position accuracy. All individual vessel POSMV files from both the launches and ship are post processed whenever possible as described in the individual survey Descriptive Reports and project Horizontal and Vertical Control Reports.

1.4.4 Trimble Backpack

Fairweather uses two GPS Pathfinder® Pro XRS receivers in conjunction with a field computer to acquire detached positions during shoreline verification in the field. Data can also

be collected with a handheld TSCe data collector. Field computers currently in use are Panasonic Toughbooks; two CF-30's, one CF-29, one CF-19, and one CF-18. The receivers have integrated beacon/satellite differential antennas which allow access to digital real-time sub-meter accuracy solutions. Data quality assurance testing was conducted by *Fairweather* personnel in April 2009. Trimble units (figure 9) were tested over a published benchmark. Trimble positions matched the published benchmark position within 0.6m. Test results are maintained with reference documentation on board *Fairweather*.



Figure 9: Trimble Backpack Unit

1.4.5 Hand-held Laser

The Impulse Laser Rangefinder (figure 10) and TruPulse 200 Laser Rangefinder (figure 11) are used in conjunction with the Trimble Backpack GPS unit to acquire distances and heights during shoreline verification. These data are entered directly into the shoreline acquisition software and annotated on the detached position forms. The Impulse LR and TruPulse 200 Laser Rangefinder do not function properly in low light or in choppy seas when a feature is not distinguishable from surroundings.



Figure 10: IMPULSE LR Laser Rangefinder



Figure 11: TruPulse 200 Laser Rangefinder

Data quality assurance testing was conducted in June 2010 by *Fairweather* personnel. Vertical and horizontal readings were taken with the laser rangefinders and compared to measurements taken with a steel tape. The laser rangefinder was set up on a tripod and a staff of known height was measured at distances of 10, 20, 50, and 100 meters. Three horizontal and three

vertical readings were taken at each interval. The results of the laser rangefinder accuracy testing are maintained with reference documentation on board *Fairweather*.

1.5 Sound Speed Equipment

1.5.1 Sound Speed Profiles

1.5.1.1 SBE 19plus SEACAT Profiler

Fairweather is equipped with three SBE 19*plus* and two SBE 19*plus*V2 SEACAT sound speed profilers used to acquire conductivity, temperature, and depth (CTD) data in the water column to determine the speed of sound through water. Two of the SBE 19*plus* profilers have pressure sensors rated to 1000 meters. The third SBE 19*plus* profiler has a pressure sensor rated to 3,500 meters. The two SBE 19*plus*V2 profilers have pressure sensors and units rated to 600 meters.

The SBE 19*plus* and SBE 19*plus*V2 SEACAT sound speed profilers were calibrated by the manufacturer in early December 2009. The current calibration files are maintained with reference documentation aboard *Fairweather*.

Periodic quality assurance checks include comparison casts between CTD instruments. Data quality assurance (DQA) checks include comparison casts between two instruments as per section 1.5.2.2.2 of the *FPM* for each survey. Records of the DQA tests performed are kept aboard the ship and are included with the digital Separates II – Sound Speed Data for each survey. To ensure that the CTDs continue to function properly a stringent maintenance schedule is followed using guidelines from the manufacturer's recommendations.

1.5.1.2 Moving Vessel Profiler 200

A Brooke Ocean Technology, Ltd. (BOT) Moving Vessel Profiler 200 (MVP 200) is mounted in the aft starboard corner of the fantail (see Figure 12). The MVP 200 system is a self contained sound speed profiling system capable of sampling water column profiles to 200 meters deep from a vessel moving up to 12 knots. The system is configured with a Single Sensor Free Fall Fish (SSFFF) outfitted with an Applied Microsystems Ltd. Sound Velocity and Pressure Smart Sensor. Deeper profiles can be obtained by reducing the vessel speed. When the vessel is holding station, the system is capable of recording casts over 400m in depth.

The MVP system consists of a winch, cable, fish (the towed unit with the sound velocity sensor), support assembly, and controlling hardware and software. During data acquisition the fish is deployed using the on-deck controller and towed with enough cable out to keep the fish 3-5 m below the water surface. A “messenger” (a short cable-thickening sleeve) is set to allow the system to keep the appropriate amount of cable out and is reset as needed when the ship acquisition speed is altered.

During SVP acquisition, the controlling computer application, BOT MVP with software version 2.4 is used to control the MVP system and to acquire SVP data. The MVP allows for three acquisition modes: 1) automatic continuous multiple cast freefall casting while at speed,

2) single cast freefall casting while at speed, and 3) single cast winch speed casting while stationary. The user limits the depth to which the fish will fall by setting 1) the depth-off-bottom 2) the maximum depth and 3) maximum cable out. Either single, individually initiated casts can be performed at the discretion of the Hydrographer or the auto deploy function can be enabled and set with varying intervals (every 10 minutes, for example) for deployment.

Fairweather has three Applied Microsystems Ltd. Sound Velocity and Pressure Smart Sensors. All of the sensors were calibrated by the manufacturer during the 2009-2010 winter repair period. The resulting calibration files are maintained with reference documentation aboard *Fairweather*.

Periodic quality assurance checks include comparison casts between the MVP and one of the SBE 19*plus* or SBE 19*plus*V2 SEACATs. Data quality assurance (DQA) checks include comparison casts among the instruments as per section 1.5.2.2.2 of the *FPM* for each survey. Records of the DQA tests performed are kept aboard the ship and are included with the digital Separates II – Sound Speed Data for each survey.



Figure 12: *Fairweather*'s MVP200 sound velocity system

1.5.2 Surface Sound Speed

1.5.2.1 Reson Sound Velocity Probe (SVP 70)

Fairweather is equipped with one Reson SVP 70. The SVP 70 measures the speed of sound near the ship's hull mounted transducers to provide real time surface sound speed values. The unit is mounted adjacent to the Reson 8160 as shown in Figure 13.



Figure 13: *Fairweather*'s SVP 70 sound speed unit (left) and the 8160

The sound speed is output to the Reson 7111 and Reson 8160's processing units. The transducers require sound velocity information for beam forming. The Reson 7111 and Reson 8160 are not used to acquire data without real time sound speed information.

The unit was installed during the 2009 winter drydock period in Seattle, Washington, at Lake Union Drydock Company. The last calibration of the unit was dated January 4, 2009; the calibration report is maintained with reference documentation aboard *Fairweather*.

1.5.2.2 Reson Sound Velocity Probe (SVP 71)

Survey launches 2805, 2806, 2807 and 2808 are each equipped with a Reson SVP 71. The SVP 71 measures the speed of sound near the transducer to provide real time surface sound speed values to the Reson 7125's processing unit. The 7125SV requires surface sound speed information for beam forming due to the flat faced transducer. The units are hull-mounted adjacent to the Reson 7125's transducers as shown in Figure 14.

All of the sensors were calibrated by the manufacturer and current calibration files were supplied with the units. Calibration files are maintained with reference documentation aboard *Fairweather*.



Figure 14: SVP 71 sound speed unit (right) and a Reson 7125

1.6 Vertical Control Equipment

1.6.1 Water Level Gauges

Two Sutron 8210 tide gauges and one 9210B Sutron tide gauge were provided to *Fairweather* by the Center for Operational Oceanographic Products and Services (CO-OPS) at the start of the 2010 field season. These gauges are equipped with Paros Scientific Sensors for pressure measurements. The tide gauges are checked annually by CO-OPS Field Operations Division personnel to ensure that their accuracy standards are being met.

CO-OPS does not provide calibration or quality assurance documentation to *Fairweather*. Installation and removal of the water level gauges is the responsibility of *Fairweather* personnel. To ensure full functionality of the vertical control equipment prior to deployment for field operations, new gauges undergo testing by *Fairweather* personnel. Three gauges underwent testing in April 2010 and results are maintained with reference documentation aboard *Fairweather*.

1.6.2 Leveling Equipment

Fairweather is equipped with four universal automatic levels (two Zeiss NI2 333 and two Leica NA2 100) and graduated metric staffs to assist in leveling tide gauges. Calibration was conducted by Kuker-Ranken Inc. on February 3, 2010, and the results are maintained with reference documentation aboard *Fairweather*.

A Kukkamaki procedure is performed prior to leveling in order to verify the collimation error. Procedures used followed those described in the *User's Guide for the Installation of Bench Marks and Leveling Requirements for Water Level Stations*, October 1987. Kukkamaki procedures were performed on March, 10, 2010 on all four levels, and the 2010 results are maintained with reference documentation aboard *Fairweather*.

1.7 Horizontal Control Equipment

Fairweather is equipped with two Trimble NetR5 receivers and one Ashtech Z-Xtreme dual-frequency GPS base stations used for the positioning of horizontal control marks, tidal benchmarks and aids to navigation. These base stations can be configured for use as a portable DGPS or RTK reference station, or as a static receiver to record observations for use in post processing kinematic (PPK) correctors.

Equipment accuracy testing of all three GPS units was performed by *Fairweather* personnel in Seattle, Washington on March 10, 2010. The Online Positioning User Service (OPUS) solutions were obtained using data acquired with all three GPS units over a local benchmark and comparing the solutions to each other and to the published data sheet for the geodetic mark used. Data compared well within the accuracy of the published position of the benchmark. The OPUS solutions are maintained with reference documentation aboard *Fairweather*.

When deployed for PPK the base stations log data locally, either to internal memory or external memory, and the data is downloaded periodically. The data is downloaded either by visiting the site or remotely via Freewave 900 MHz spread spectrum Ethernet radios mounted to *Fairweather* and her launches. Station power needs are supported by batteries and solar panels.

The Ashtech antenna can be equipped with an optional ground plane and all receiver antennas are used with a Seco fixed height GPS tripod. Horizontal control equipment serial numbers and version installation dates are located in the hardware section of Appendix I.

2.0 Software

2.1 Software Systems Inventory

An extensive software inventory with documentation of the software systems used by *Fairweather* is maintained as a survey *Software Inventory* spreadsheet on board *Fairweather*. This spreadsheet includes specifics such as software applications, versions, and hotfixes that are loaded on specific survey processing computers. Snapshot .pdf files are produced monthly. The pertinent monthly inventories are included with the Supplemental Survey Records for the individual Descriptive Reports.

2.2 Data Acquisition Software

2.2.1 Hypack® Hysweep

Fairweather uses the Hypack® Hysweep acquisition software package to log all Reson MBES data. Hysweep displays real-time MBES coverage geo-referenced against supporting background files such as charts and vector shoreline files for launch and ship helmsman to

follow to acquire adequate MBES coverage. The Hypack Devices (Hysweep Interface, Applanix POS/MV Network, AIS, and MVP) and Hysweep Hardware (Hypack Navigation, Applanix POS/MV Network, and Reson) setups are set in accordance with HSTP's configuration management documentation.

Three types of files are recorded per logged line of Reson MBES data: .raw, .hsx, and .7k. The .raw file contains the raw navigation files recorded directly from the POS/MV (device 1) and from Hysweep (device 0). The .hsx files contain raw data from the Hysweep Interface (device 0), the POS/MV (device 1) and the Reson MBES (device 2). The .7k file contains all raw data that Hysweep can read from the Reson, including the Reson 7008 snippets message.

The .hsx and .raw files are converted into HDCS data in CARIS HIPS by *Fairweather* personnel. The .7k file is not post-processed by *Fairweather* personnel but is recorded for use by the Integrated Ocean and Coastal Mapping (IOCM) Center for research on backscatter processing and product development. All three raw files are submitted for archival at NGDC via the IOCM Center in accordance with the Office of Coast Survey's Backscatter Acquisition, Processing, Quality Check and Archival Pipeline Project. Additionally, the MBES sensor offsets and mounting biases are entered into the respective vessel's Hysweep Hardware device to facilitate IOCM's backscatter processing using Hypack GeoCoder. Entry of device offset values in Hysweep Hardware causes the values to be logged in the header of the .hsx only, and does not affect the data pipeline. These values are not tracked or closely monitored aboard *Fairweather* because they are part of IOCM's backscatter development project and not otherwise integral to meeting the requirements of the 2010 HSSD.

2.2.2 CARIS Notebook

CARIS Notebook™ can be used to directly collect detached shoreline positions and to verify shoreline. The software is run on a field computer and receives the Trimble GPS data output from the GPS Pathfinder® Pro XRS receivers.

GPS settings in CARIS Notebook are as follows:

Maximum Horizontal Dilution of Precision (HDOP) = 3

Maximum Positional Dilution of Precision (PDOP) = 6

Minimum Signal-to-Noise Ratio (SNR) = 12

Minimum Elevation Mask = 8°

Minimum # of Satellites = 4

Real-Time settings in CARIS Notebook are as follows:

Source Type: Integrated Beacon – Manual Mode

Position Mode: Corrected Only

Age Limit: 20 seconds

Differential GPS correction is applied in real-time using the unit's integrated beacon as the primary corrector. The unit can be setup to run without using DGPS with position mode set to "Autonomous Only" or with values different than those listed above. These special circumstances of acquisition with altered parameters are recorded and documented in the individual Descriptive Report as appropriate.

2.2.3 Klein SonarPro

Klein SonarPro is a custom display and acquisition software package for use with Klein Side Scan sonar systems. *Fairweather* uses SonarPro to monitor the quality of real-time imagery and to log raw side scan files in .SDF file format while acquiring Klein 5000 Side Scan data from the sled-mounted systems configurable on any of *Fairweather's* launches. Vessel navigation data from the POS/MV is supplied to SonarPro and logged in the SDF file. The raw SDF files are converted using CARIS SIPS into HDCS files for post processing and analysis.

2.2.4 Applanix POSView

Applanix POSView is the controller software for the POS/MV. POSView is used to configure the serial and network input and output ports on the POS/MV PCS. POSView is also used to monitor real-time position and attitude data and their associated accuracies and to log POSPac .000 files. The POSPac .000 file contains the TrueHeave information that is applied to the MBES HDCS data in CARIS HIPS immediately after conversion. The POSPac .000 file is also post-processed into a PPK SBET file using Applanix's POSPac processing software.

2.3 Data Processing Software

2.3.1 CARIS

CARIS HIPS™ (Hydrographic Information Processing System) is used to process all multibeam data including data conversion, filtering, sound speed corrections, tide correction, merging and cleaning. CARIS HIPS also calculates the Total Propagated Uncertainty (TPU) used to produce Bathymetry Associated with Statistical Error (BASE) surfaces which assist the Hydrographer in data cleaning and analysis, and to produce BASE surfaces.

CARIS SIPS™ (Sonar Information Processing System) is used to process all side scan imagery data including data conversion, slant-range correction, beam pattern correction, and despeckling, if appropriate. CARIS SIPS is also used to inspect the imagery for contacts and to produce side-scan imagery mosaics.

CARIS Notebook™ is used to compile, display, and edit source shoreline, shoreline updates and S-57 features that are collected directly in the field, digitized, or imported. The .hob files created in Notebook are the current shoreline deliverables.

CARIS Bathy DataBase™ BASE Editor is used for data quality assurance checks on the BASE surface and .hob deliverables and for surface differencing and comparisons.

CARIS Plot Composer is used to create final field plots and special constituent products.

2.3.2 Fledermaus™

Fledermaus™, an Interactive Visualization Systems 3D™ (IVS 3D) program, is used for data visualizations and creation of data quality control products, public relations material and reference surface comparisons.

If warranted, Fledermaus™ can be used to examine the CARIS surfaces prior to submission. The combined BASE surface is exported from CARIS and then converted to a Fledermaus .sd file via the Avggrid and Dmagic modules.

2.3.3 Geocoder

The Hypack version of Geocoder software originally developed by Dr. Luciano Fonseca at the University of New Hampshire's Center for Coastal and Ocean Mapping (CCOM) is used occasionally by senior *Fairweather* personnel to check Reson Snippet backscatter data and to create backscatter mosaics. *Fairweather* also possesses a copy of the University of New Hampshire CCOM implementation of Geocoder for testing and comparison purposes.

2.3.4 Applanix POSPac MMS and POSGNSS

Applanix POSPac MMS and POSGNSS are used to post process POS/MV data files logged simultaneously during MBES acquisition. The Single Base PPK processing method is typically used when a single *Fairweather* or third party GPS base station is operating within approximately 20 kilometers of MBES acquisition. The SmartBase™ PPK processing method is used when a stable network of approximately 5-10 available third party GPS base stations such as those in the Continuously Operating Reference Station (CORS) system or Plate Boundary Observatory (PBO) suite of stations exists within approximately 200 kilometers of MBES acquisition. On occasion Precise Point Positioning (PPP) is used when sufficient base stations are not available for Single Base or SmartBase™ PPK. In general, *Fairweather* processing procedures follow the methods outlined in the *POSPac MMS GNSS-Inertial Tools User Guide* for each method. Processing methods specific to each project are documented in the Project Horizontal and Vertical Control Report. Processing methods specific to each survey are documented in the Descriptive Report

2.3.5 Velocipy

Velocipy is a NOAA in-house software supported by the Hydrographic Systems and Technology Program (HSTP) that is used to process raw sound velocity cast files taken with the SEACAT CTDs on the launches and the MVP from the ship. Velocipy creates CARIS format .SVP files that are applied during post processing in HIPS to MBES HDCS data to correct for sound speed. The individual CTD and MVP files are concatenated into a single vessel file by survey. Each vessel file contains the survey registry number and the time and location of each sound speed profile measured.

2.3.6 Pydro

Pydro, another NOAA program produced and maintained by HSTP, is used to produce Final Water Level Requests along with DTON Reports. In addition, Pydro is used for Tidal Constituent and Residual Interpolation (TCARI) tide application in conjunction with CARIS HIPS and various other macros.

3.0 Vessels

3.1 Vessel Inventory

Fairweather (S220) and her survey launches 2805, 2806, 2807, and 2808 are equipped to acquire multibeam echosounder (MBES) and sound speed profile (.svp) data. The AMBAR (2302) and SeaArk (1905) are used primarily during shoreline verification, bottom sampling, and horizontal and vertical control operations. All vessels may be used in support of dive, tide gauge, and horizontal control operations as well as for feature verification and bottom sampling. See Appendix I for the complete vessel inventory.

3.2 Noise Analysis

Fairweather sonar systems, the current Reson 8160 unit and the earlier Reson 8111ER unit, underwent noise analysis testing on October 10 and 11, 2004, respectively. Due to the change to the 7111 unit and alterations to the shaft bearings on *Fairweather* since these surveys, the results are likely out of date and are no longer followed. It is recommended that new Noise Analysis testing be conducted for both the Reson 7111 and 8160 systems.

4.0 Data Acquisition

4.1 Horizontal Control

A complete description of horizontal control will be included in the project's *Horizontal and Vertical Control Report (HVCR)*, submitted for each project under separate cover when necessary as outlined in section 8.1.5.2 of the *HSSD* and section 5.2.3.2.3 of the *FPM*.

The horizontal datum for all projects is the North American Datum of 1983 (NAD83) unless otherwise noted in the individual descriptive reports.

Multibeam and shoreline data are differentially corrected in real time using correctors provided by Coast Guard beacons. The specific beacons used for a given survey will be included in the Horizontal Control section of the survey's descriptive report. If loss of the differential beacon resulted in any data being recorded with C/A GPS positions it will be noted in the Descriptive Report for the specific survey.

When possible real time DGPS positioning may later be replaced with a post processed kinematic (PPK) single best estimate of trajectory (SBET). The PPK solution is usually dependent on a local base station supported by the ship and processed in Applanix POSPac MMS software using Single Base mode. However, in areas with an adequate network of Continuously Operating Reference Stations (CORS) or public third-party base stations, Applanix POSPac SmartBase™ mode may be used. The resulting navigation from PPK is an improvement over C/A and DGPS navigation. The details of PPK use and application for a given survey will be included in the Horizontal Control section of the project's *HVCR* or the survey's descriptive report.

4.2 Multibeam Echosounder Acquisition and Monitoring Procedures

Acquisition methods and platforms used are determined based on consideration of sonar system specifications, seafloor topography, water depth, and the capability of the acquisition platforms.

All multibeam data are acquired in Hypack's Hysweep® SURVEY extension (.hsx) format and monitored in real-time using the 2-D and 3-D data display windows and the on-screen displays for the Reson 7125SV, Reson 7111, and Reson 8160. Adjustable parameters that are used to control the Reson include range scale, power, gain, pulse width, absorption, and spreading. These parameters are adjusted as necessary to acquire the highest quality of bathymetry and backscatter. Vessel speed is predominantly between 6-8 knots for acquisition with launch 7125SV systems. For Reson 7111 and Reson 8160 acquisition systems, vessel speeds are 6-7.5 knots. Speeds are reduced as needed to eliminate noise from the data and to ensure the required along-track coverage for object detection in accordance with the *HSSD*.

Survey personnel follow standard operating procedures documented aboard *Fairweather* while setting and utilizing the Reson systems and Hypack for data acquisition. The sensor offsets and mounting biases are entered into the Hysweep® Hardware Reson device. This information is recorded in the Hypack hsx file header for corrected backscatter mosaics created with Hypack Geocoder. These offsets do not have any effect on CARIS HIPS HDCS sounding corrections.

Navigation and motion data are acquired and monitored in POSView and logged into a POS/MV file with a .000 extension. Various position and heading accuracies, as well as satellite constellations, are monitored real-time both in POSView and Hypack Hysweep®.

Main scheme MBES acquisition lines using the Reson 7125SV, Reson 7111, and Reson 8160 are generally run parallel to the contours and spaced no greater than three to four times the water depth and in most cases at a tighter line spacing to ensure the appropriate data density for the required finalized BASE surface resolutions. For discrete item developments, line separation is reduced to two times the water depth to ensure least-depth determination by multibeam near-nadir beams. Hypack Hysweep® real-time coverage display is used in lieu of pre-planned line files. Hysweep® displays the acquired multibeam swath during acquisition and is monitored to ensure overlap and full bottom coverage. If coverage is not adequate, additional lines are run while still in the area.

For areas where shoreline verification is not conducted before multibeam, extra caution is taken by "half stepping" shoreward when operating near shore. Half stepping is done by driving along the edge of real time coverage to prevent the survey vessel from ever being in un-surveyed waters. Survey launch crews in the field survey to the Navigable Area Limit Line (NALL) line as defined by section 1.1.2 of the *HSSD*.

4.3 Shoreline/Feature Verification

The composite source file (CSF) in S-57/.000 format provided with the Project Instructions is the primary source for shoreline features to be verified. The original project file is imported into CARIS Notebook, converted to a .hob file, clipped to the sheet limits for the specific

survey, and named H#####_Original_Composite_Source.hob to be included with the deliverables. This file is then copied and named H#####_Feature_File.hob to be utilized during field verification. Additionally, AWOIS items and other features to be investigated are provided to the field in the project reference file (PRF). These items are parsed into separate .hob files and are used for investigations and during shoreline verification.

Fairweather personnel conduct limited shoreline verification and reconnaissance at times near predicted negative tides within the survey limits, as directed by section 3.5.5.3 of the *FPM*. Detached positions (DPs) are acquired and edits to the daily field feature files are recorded in CARIS Notebook and on paper DP forms and boat sheets.

An inshore limit buffer line, offset 0.8 mm at the scale of the largest chart in the area, is provided with the Project Instructions or created by offsetting from the composite source Mean High Water (MHW) line. This inshore limit buffer line is used in the shoreline acquisition software and on the boat sheet as a reference, and utilized as described in section 1.1.2 of the *HSSD*. The NALL is determined in the field as the farthest off-shore of one of the following; the MHW inshore limit buffer specified above, the 4-meter depth contour, or the inshore limit of safe navigation as defined by the *HSSD*. All shoreline features from the CSF seaward of the NALL are verified (including an update to depth and/or position as necessary) or disproved during operations. Features off-shore of the NALL and not addressed or features of an ambiguous nature include remarks for further clarification.

Detached positions (DPs) acquired during shoreline verification indicate new features, revisions to source features, or source features not found in the field. They are recorded in the shoreline acquisition software and on DP forms.

4.4 Bottom Samples

Bottom samples are acquired according to section 7.1 of the *HSSD*, any deviations from this protocol will be outlined in the individual Descriptive Report for the survey. Samples are acquired using CARIS Notebook, Hypack target files (.tgt), or by logging the latitude, longitude, and bottom characteristics manually. All samples are processed similarly to other shoreline features as outlined below in section C - 2.2 of this report. Bottom sample results are included in the Notebook .hob deliverable layer, HXXXXXX_Final_Feature_File and are descriptively attributed as New.

C. QUALITY CONTROL

Fairweather has numerous standard operating procedures (SOPs) that are followed by personnel throughout the survey to ensure consistent high quality data and products.

1.0 Uncertainty Modeling

Error values for the multibeam and positioning systems on *Fairweather* and her survey launches were compiled from manufacturer specification sheets for each sensor (Heave, Pitch, Roll, Position, and Heading) and from values set forth in section 4.2.3.6 and Appendix 4 – CARIS HVF Uncertainty Values of the 2010 *FPM*.

Estimates for the Motion Reference Unit (MRU) alignment errors are taken from the standard deviation of the values determined by multiple personnel processing the patch test data (see section C 4.0). In some instances, outlier patch test values are excluded to allow more reasonable MRU uncertainty values.

The *Fairweather* TPU Values spreadsheet located in Appendix III, lists the final uncertainty values for *Fairweather* and her launches, including the default tides and sound velocity values. Uncertainty values relating to vessels and survey systems are entered into the HIPS Vessel File (HVF) for each platform. The tidal errors for the gauge and for zoning are determined on a project by project basis. Sound speed uncertainties for a given survey are based upon either the defaults listed in the TPU value spreadsheet or based on utilization of NOAA sound speed uncertainty estimation software. Survey specific uncertainty values for tides and sound speed that are entered during the Compute TPU step in CARIS HIPS and how they were determined will be included in the individual Descriptive Report.

2.0 Data Processing

2.1 Multibeam Echosounder Data Processing

Bathymetry processing followed section 4.2 of the *FPM* unless otherwise noted.

Raw .hsx multibeam data are converted to CARIS HIPS HDCS format using established and internally documented settings. After TrueHeave™, sound speed, and water level correctors are applied to all lines, the lines are merged. Once lines are merged, Total Propagated Uncertainty (TPU) is computed.

The general resolution, depth ranges, and Combined Uncertainty and Bathymetric Estimator (CUBE) parameter settings outlined in section 5.2.2.2 of the *HSSD* and section 4.2.1.1.1.1 of the *FPM* are used for surface creation and analysis. These depth range values for specific resolutions may require adjustment by sheet managers for individual surveys to address visualization gaps between finalized surfaces in areas of steep slopes. A waiver from HSD Operations is requested by project when the prescribed finalized depth ranges are not used for analysis and submission. A detailed listing of the resolutions and the actual depth ranges used during the processing of each survey, along with the corresponding fieldsheet(s), will be provided in the Descriptive Report of each survey.

BASE surfaces are created using the CUBE algorithm and parameters contained in the NOAA CUBEParams_2010.xml file as provided in Appendix 4 of the *FPM*. The CUBEParams_2010.xml will be included with the HIPS Vessel Files with the individual survey data. The NOAA parameter configurations for resolutions 1-32 meters are used.

Multibeam data are reviewed and edited in HIPS swath editor and in subset mode as necessary. The finalized BASE surfaces and CUBE hypotheses are used for directed data editing at the appropriate depth range in subset editor. The surfaces and subset editor view are also used to demonstrate coverage and to check for errors due to tides, sound speed, attitude and timing.

Vessel heading, attitude, and navigation data are reviewed in HIPS navigation editor and attitude editor if deemed necessary upon review of surfaces. Where necessary, fliers or gaps in heading, attitude, or navigation data are manually rejected or interpolated for small periods of time. Any editing of this nature will be outlined in the Descriptive Report for the particular survey.

The Surface Filtering functionality in HIPS may be used in the processing of survey data to reject errant soundings. If utilized, the individual Descriptive Report shall list the confidence level settings for standard deviation used and discuss the particular way the surface filter was applied.

In depths less than 20 meters and deeper and in areas of navigational significance where the BASE surface does not depict the desired depth for the given area, a designated sounding is selected. Designated soundings are selected as outlined in section 5.2.1.2 of the *HSSD*.

Layers determining “IHOness” are added to the CUBE surfaces allowing the Hydrographer to see where and if the surfaces meet IHO Order. The process is easily performed in HIPS and allows the Hydrographer to identify areas of high uncertainty with respect to depth. This is a spatial quality control check rather than just a statistical list of nodes and allows for specific areas with problems to be isolated and addressed. The following logic equation is used to create “IHO_1” child layers in the 1 through 8 meter finalized surfaces:

(IHO-1: $((0.5^2 + ((\text{Depth} * 0.013)^2))^0.5) - \text{Uncertainty}$),

and an “IHO_2” child layer is created in the 8, 16 meter, and greater finalized surfaces using

(IHO-2: $((1^2 + ((\text{Depth} * 0.023)^2))^0.5) - \text{Uncertainty}$).

It should be noted that both IHO order 1 (~80 to 100) and order 2 (100 to 176) child layers are created for the 8 meter surface since it overlaps the order 1 and order 2 boundary (order 1 < 100 meters, order 2 > 100 meters). IHO surfaces are utilized during data collection and processing as an additional child layer of the finalized surfaces to indicate problem areas that need attention or discussion. Additionally, the percentage of IHO nodes passing from the combined finalized surfaces is included in the Descriptive Report for each survey. For visual depiction of localized areas that do not meet IHO standards, screen grab(s) of the individual finalized IHO child layer(s) may also be included.

The individual finalized or combined surface’s IHO layers are exported from CARIS as a text file and examined to allow the Hydrographer to see the full data distribution rather than just the minimum and maximum values in the surface. These data distributions are used to assess the quality of the survey, to ensure ninety-five percent of the data meets the appropriate IHO order as specified in section 5.1.3 of the *HSSD*.

Additionally, a combined surface is reviewed in 3-D mode using one of the following programs, CARIS HIPS, CARIS Base Editor, or IVS Fledermaus, to ensure that the data are sufficiently cleaned for submission.

2.2 Shoreline/Feature Data Processing

During shoreline verification, field detached positions (DP) are acquired with CARIS Notebook or Hypack .tgt files. Tide application for features requiring tide correction is applied in CARIS Notebook when using discrete zoning and with the aid of Pydro when TCARI is used.

New features and any updates to the composite source shoreline, such as ledges or reefs, are acquired or digitized with S-57 attribution and are compiled from the field daily files into the H#####_Final_Feature_File.hob. Updates to source shoreline features primarily include a change in depth/height, position, or S-57 classification. Notebook's editing tools are used to modify source feature extents or positions.

The SORIND and SORDAT S-57 attribute fields for new features or modified source features are updated to reflect the information for the associated survey number and date (US,US,graph,H#####). All new or modified features are S-57 attributed as applicable and descriptively attributed as New or Update respectively. All unmodified source features retain their original SORIND and SORDAT values. Assigned features that are addressed but not updated are descriptively attributed as Retain and unaddressed assigned features are attributed as Not Addressed.

Short descriptive comments taken from the boat sheets or DP forms along with investigation or survey methods are listed under the Remarks field. For significant features that deserve additional discussion, the Hydrographer may include a recommendation to the cartographer in the Recommendations field, along with the Hydrographer notes and investigation methods provided in the Remarks field.

Features that are disproved or that do not adequately portray the shoreline are descriptively attributed as Delete in the H#####_Final_Feature_File.hob layer. Features with the attribution of Delete retain their original SORIND and SORDAT values and include a recommendation from the Hydrographer along with an informative remark.

AWOIS investigation items are received in the Project Reference File and investigated as necessary. Shoreline features correlated to the AWOIS item are included in the H#####_Final_Feature_File.hob layer and labeled with the appropriate AWOIS number and include a remark detailing the search methods and a recommendation from the Hydrographer. Items will be attributed as AWOIS for reporting purposes. Any features that are submitted as dangers to navigation (DTON) will be attributed accordingly for reporting purposes. The status of Primary or Secondary may be attributed to aid in deconflicting multiple positions or instances of the same feature.

Photos are labeled and associated with a DP/userid number or other descriptive/unique name. They are included with the survey data and stored in the CARIS/Multimedia folder with the deliverables. References to the photos are listed with file extension and comma delimited in the Images attribute for the specific feature.

The CARIS Notebook files along with CARIS HIPS BASE surface(s) are viewed to compare MBES coverage and features simultaneously. The current NOAA object catalog will be used for CARIS Notebook processing and the version of such will be documented in the individual Descriptive Reports, along with any deviations in shoreline processing from those listed above.

Final shoreline deliverables are two Notebook HOB files, the H##### Original Composite Source and the H##### Final Feature File, included with the CARIS data. A feature listing, which includes S-57 and other attribution of items addressed by the survey, in either geography markup language (.gml) and/or as a Microsoft Excel spreadsheet or equivalent is included in Appendix II of the individual Descriptive Report.

3.0 Data Review

Specific procedures are used on *Fairweather* to ensure quality control of data throughout acquisition, processing, and submission. These procedures are documented and followed by the Hydrographer. A detailed Quality Control check is performed by the survey manager. A detailed review is conducted by qualified survey personnel (FOO, CST, SST, or PS) other than the survey manager as an outside review of the survey data and deliverables. Submission checklists are used to ensure that all data and deliverables are complete and included upon submission. Documentation of these tasks is completed for every survey but only the final processing log, H##### Data Log, is included in the Separates submitted with the individual survey data.

D. Corrections to Echo Soundings

1.0 Vessel HVFs

CARIS HIPS Vessel Files (HVF) are created by *Fairweather* personnel and used to define a vessel's offsets and equipment uncertainty. The HVF is used for converting and processing raw Hypack .hsx and .raw files to CARIS HIPS HDCS format. The HVFs used for a given project are included with the digital data submitted with the survey.

2.0 Vessel Offsets

Sensor offsets are measured with respect to each vessel's reference point. The reference point for *Fairweather* and her survey launches 2805, 2806, 2807, and 2808 is the top, center of the POS/MV IMU (Figure 15). The offset values from the reference point to the primary GNSS antenna are entered into Applanix's POSView POS/MV monitoring software so that all raw position data are centered at the vessel's reference point. The CARIS HVF contains the offset from the vessel's reference point to the multibeam sonar reference point.



Figure 15: Vessel Reference Point (Center of POS/MV IMU) and Primary GNSS Antenna (port side antenna).

Additionally, the Reson sonar mounting offsets measured from the center of each projector to the center of the transceiver are entered in the Reson 7125 hardware configuration with the 7K Center for both the 400 kHz and 200 kHz projectors. The measured values are used instead of Reson's default values because *Fairweather's* mounts are slightly different than of Reson's standard sonar mount (Figure 16).

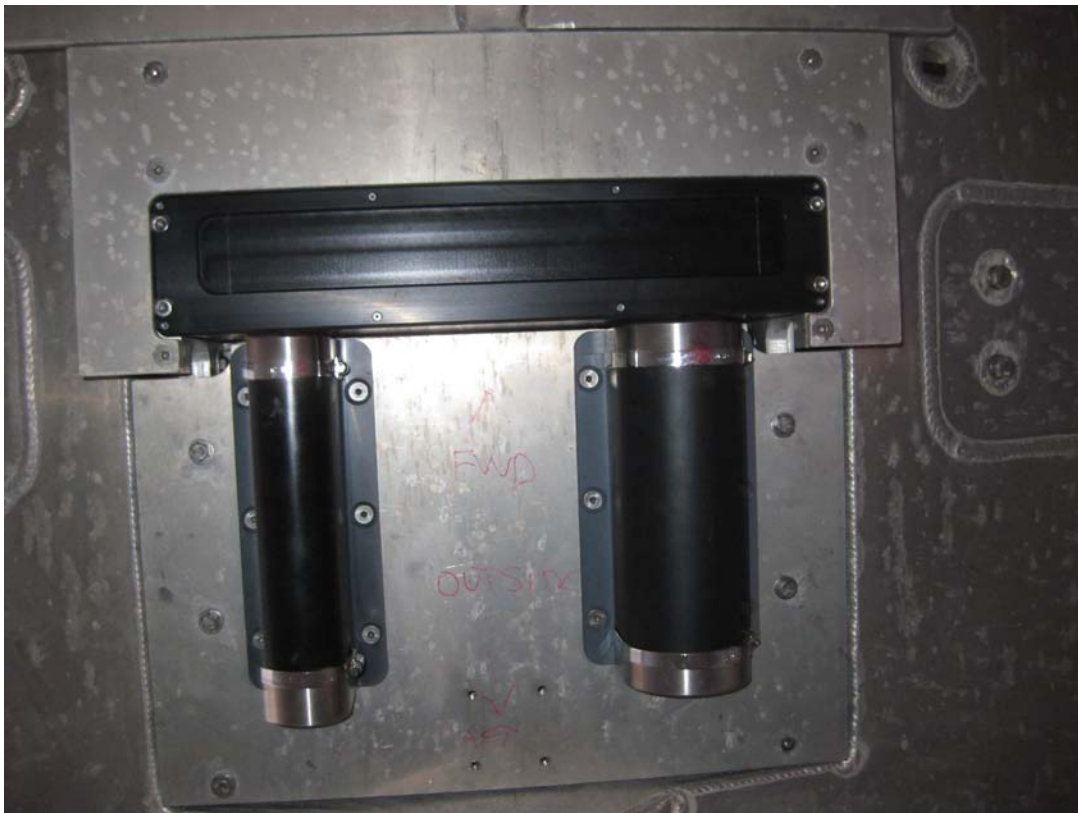

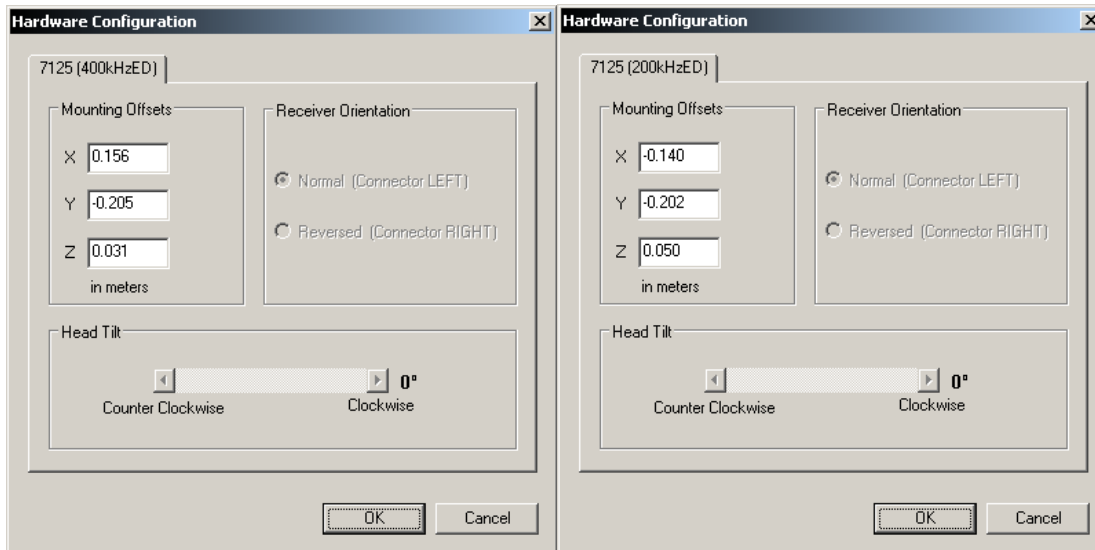

Figure 16: Reson 7125 sonar mounting with 400kHz and 200kHz offsets respectively.

A ship survey of *Fairweather* was completed by Westlake Consultants, Inc on September 23, 2003. A spatial relationship survey of *Fairweather* POS/MV components was conducted by NOAA's National Geodetic Survey (NGS) in February 2007, and again on February 15, 2009, while the ship was in Lake Union Drydock in Seattle, WA. The results of the Westlake, the 2009 NGS survey, and additional offset values discussed below in section D 4.0 are used to determine the offsets for the ship. The reports from each survey, whose values are used for the offset measurements, are located in Appendix II. The *S220 Offsets & Measurements* spreadsheet is also included in Appendix II, listing the final values for *Fairweather's* offsets with explanations of how they were calculated.

Permanent control points were established on launches 2805, 2806, 2807, & 2808 during construction at All American Marine in 2009. Sensor offsets were measured by NGS in January 2010 using the methods described in the report on each launch located in Appendix II of this report. The resultant offsets, measurements, derivations, descriptions of methodology used, diagrams, and coordinate system references are included in the respective vessel's *Offsets & Measurements* spreadsheet also included in Appendix II.

3.0 Static and Dynamic Draft

The static drafts (*Waterline Height* in the HVF) for launches 2805, 2806, 2807, and 2808 were calculated based on steel tape measurements of the distance from benchmarks on the port and starboard quarter of the vessel to the waterline. The values and calculations for static draft of the various launches are listed in the respective *Waterline Measurement* spreadsheets included in Appendix II of this report.

The static draft of *Fairweather* was measured under different loading conditions with different amounts of fuel. The bow and stern draft marks were recorded and then used to perform a linear interpolation of the static draft at *Fairweather's* IMU. The *Ship Draft 2010* spreadsheet

records the static draft values and is included with the ship offset documentation in Appendix II.

Fairweather's dynamic draft measurement was taken February, 2010 in Lake Washington while the ship was transiting from Sand Point to South Seattle. The dynamic draft of launches 2805, 2806, 2807, and 2808 were measured similarly in Lake Washington in March, 2010. The measurements were made using the change in ellipsoid height while traveling at different speeds in Lake Washington. The ellipsoid heights were determined using Post Processed Kinematics (PPK) by recording POSPac data on each vessel and then processing the data with local reference stations in Applanix POSPac MMS software. The resulting Single Best Estimate of Trajectory (SBET) was exported from POSPac and the speed versus ellipsoid height was fit to a polynomial curve using a least squares fit method in a Python Script written by NOAA personnel and implemented within Pydro. The polynomial curve was used to derive the table used in the CARIS HVF, and the standard deviation of the residuals was used to determine the associated uncertainty in the measurement. Written reports for each platform about the initial measurements carried out in February and March are provided in Appendix II of this report. The polynomial best fit curve of the ellipsoidal height differences from launches 2805, 2806, and 2808 compare well with each other. Due to IMU issues with launch 2807, the ERDDM failed several times before finally being successfully completed on May 23rd, 2010 in the Behm Canal working grounds after the faulty IMU was replaced. The values obtained during this measurement were compared to the other launches and were found to compare favorably. The dynamic draft offset values and standard deviation were then entered into the two 2807 CARIS HVFs.

4.0 Patch Tests

Patch tests were conducted on launches 2805, 2806, 2807 and 2808 for the Reson 7125SV MBES sonar systems during the month of March 2010 using the Shilshole Bay Reference Surface and Patch Test site near Seattle, WA. Additional patch tests were conducted on launch 2807 in April 2010 after the IMU failed and was replaced with a spare unit.

Patch tests were conducted for *Fairweather's* Reson 8160 and Reson 7111 MBES sonar systems during May, 2010, near Ketchikan, AK. A second roll bias test for the Reson 7111 was conducted on July 14, 2010, near Dutch Harbor, AK, and the value post-applied to all Reson 7111 data acquired in 2010. The results of all patch tests to date, along with the acquisition and processing logs, are included in the individual MBES Calibration files in Appendix II.

Also included in Appendix II is the Sounding System Comparison. This comparison includes surface differencing between all launch and ship MBES reference surfaces using CARIS Bathymetry Database. Since all launch reference surfaces closely agree with one another, only launch 2805 Reson 7125's reference surface was differenced with the ship's Reson 7111 and Reson 8160 reference surfaces. The results of the comparison show that the Reson 8160 data are on average 0.206 meters deeper than the launch data, and that the Reson 7111 data are on average 0.322 meters deeper than the launch data. Due to this measured offset and similarly observed offsets between launch and ship systems during the past several field seasons, the ship

multibeam system HVF vertical Z-values (FA_S220_Rsn7111_301bms_2010.hvf and FA_S220_Rsn8160_5to750_2010.hvf) have been adjusted to reflect this measurement. The values are listed under 'Correction based on Reference Surface' and are included in the S220 *Offsets & Measurements* spreadsheet located in Appendix II.

5.0 Attitude and Kinematic Data

Vessel attitude is measured by the POS/MV and recorded in the Hysweep .hsx file. Roll is applied real time to Reson 8160 and Reson 7125SV data. Pitch is applied real time to Reson 7111 and Reson 8160 data. Attitude measurements not applied in real time (heave, pitch, roll, and heading) are applied during post processing in CARIS HIPS using the raw POS/MV attitude data recorded in the Hysweep .hsx file. Post processed kinematic (PPK) data from the POS/MV .000 file are applied to MBES data in CARIS HIPS in the form of SBET files once all data acquisition is complete.

The POS/MV IMU uncertainty values for heave, pitch, roll, and heading measurements were derived from the manufacturer specifications and are listed in the *Fairweather TPU Values* spreadsheet located in Appendix III of this report. When PPK data are applied, the error file associated with the SBET is applied in CARIS HIPS to include the uncertainty of the PPK data in the total propagated uncertainty estimation of each sounding. This practice is a known issue that artificially inflates the total propagated uncertainty estimation because CARIS HIPS does not remove the real-time POS/MV heave, pitch, roll, and heading values when the SBET error file is applied.

5.1 TrueHeave™

The POS/MV TrueHeave™ data is logged within the POS/MV .000 files and applied in CARIS HIPS during post processing using the "Apply TrueHeave" function. TrueHeave™ is a forward-backward filtered heave corrector as opposed to the real time heave corrector, and is fully described in Section 6 of the *POS/MV Version 4 Installation and Operation Manual*. To ensure proper application in CARIS HIPS, POS/MV files are logged for at least three to five minutes before and after all MBES files are logged.

If the POS/MV files fail to apply in CARIS HIPS during the "Apply TrueHeave" process the files are fixed using a CARIS tool called "fixTrueHeave.exe." In cases where this is necessary a new fixed file is created with the extension ".fixed" (2010-ddd-vssl.000.fixed). The new fixed TrueHeave™ file is then applied to the data in CARIS HIPS. The original corrupted file is retained along with the fixed file with the submitted Global Navigation Satellite System (GNSS) data. Occurrences of this for specific surveys are noted in the individual Descriptive Reports.

In cases where TrueHeave™ cannot be applied, real time heave correctors are used. Real time heave data are recorded and stored in the Hypack Hysweep .hsx file and are applied as the heave corrector for MBES data if TrueHeave™ files are unavailable. Data that do not have TrueHeave™ applied will be listed in the individual Descriptive Report for the survey.

5.2 Post Processed Kinematic Data

Post Processed Kinematic (PPK) data in the form of Single Best Estimate of Trajectory (SBET) files are applied to soundings to increase the accuracy of the kinematic vessel corrections and to allow the ability to reference soundings to the ellipsoid.

Standard daily data processing procedures aboard *Fairweather* include post processing of POS/MV kinematic .000 files using Applanix POSPac MMS and POSGNSS software using either Single Base or SmartBase batch processing methods as described in section B.2.3.4. After processing and quality control analysis of the post-processed SBET files is complete, the SBET and SMRMSG files are applied to the HDCS data in CARIS HIPS using the “Load Attitude/Navigation Data”, the “Load error data...”, and “Compute GPS Tide” processing tools. Ellipsoidal heights are contained within the PPK SBET files. Soundings to which SBETs have been applied can be reduced to the ellipsoid by merging the data in CARIS HIPS with “GPS Tide” applied. Data are frequently referenced to the ellipsoid during data analysis for troubleshooting unexplained vertical offsets.

Positioning of features and bottom samples is not corrected with post processed GNSS data because at this time as there is not a developed nor streamlined procedure for PPK application to features.

6.0 Sound Speed

Seabird SBE 19*plus* and SBE 19*plus*V2 sound speed profilers are used regularly to collect sound speed data for the Reson 7125SV MBES systems on survey launches 2805, 2806, 2807, and 2808, and used on an as needed basis for *Fairweather*'s Reson 7111 and Reson 8160 MBES systems. The Brooke Ocean Technology Moving Vessel Profiler (MVP) is primarily used to collect sound speed data for sound speed correction of data acquired with *Fairweather*'s Reson 7111 and Reson 8160 MBES systems.

Daily sound speed profiles from the SBE 19*plus* and SBE 19*plus*V2 profilers are processed with Velocipy and concatenated into single .svp files for each vessel per survey. Individual .svp files and the concatenated vessel files for the survey are submitted with each survey.

Sound speed profiles acquired using the Brooke Ocean Technology Moving Vessel Profiler 200 (MVP) are stored in files labeled BOT_XXXX.calc, where X is the incrementally increasing cast number. The .calc file for each cast is opened with Velocipy and converted into CARIS .svp file format. The individual .svp profiles are concatenated into vessel specific .svp files for the entire survey. Individual sound speed profiles taken by the MVP are not submitted separately due to the large number of casts acquired and the way in which they are processed; however, the daily concatenated files are submitted for backup purposes and include all profiles acquired.

The concatenated sound speed files are applied to multibeam data in CARIS HIPS during data processing. CARIS HIPS uses one of four different methods to automatically apply a sound speed profile stored in a concatenated sound speed file. They are: “previous in time,” “nearest

in time,” “nearest in distance” and “nearest in distance within time.” The method of applying sound speed for a specific day of data collection is listed in the daily logs included as Separates submitted with the individual survey data.

7.0 Water Level

Unless otherwise noted in the survey Descriptive Report, the vertical datum for all soundings and heights is Mean Lower Low Water (MLLW). Predicted, preliminary, and/or verified water level correctors from the primary tide station(s) listed in the Project Instructions may be downloaded from the CO-OPS website and used for water level corrections during the course of the project. These tide station files are collated to include the appropriate days of acquisition and then converted to CARIS .tid file format using FetchTides, HydroMI in MapInfo, or the NOAA stand-alone Create HIPS Cowlis .exe.

Water level data in the .tid files are applied to HDCS data in CARIS HIPS using the zone definition file (.zdf) or a Tidal Constituent and Residual Interpolation (TCARI) model supplied by CO-OPS. Upon receiving final approved water level data, all data are reduced to MLLW using the final approved water levels as noted in the individual survey’s Descriptive Report.

A complete description of vertical control utilized for a given project can be found in the project specific *Horizontal and Vertical Control Report (HVCR)*, submitted for each project under separate cover when necessary as outlined in section 5.2.3.2.3 of the *FPM*.

Appendix I

System Tracking

Vessel Inventory

Hardware Inventory

Computer Inventory

Hydrographic Vessel Inventory

Field Unit: FAIRWEATHER
 Effective Date: April 12, 2010
 Updated Through: August 9, 2010

| SURVEY VESSELS | | | | | | | | |
|--|--|---|--|---|--|-------------------------|-----------------|-------------------------|
| Vessel Name | FAIRWEATHER | Launch 2805 | Launch 2806 | Launch 2807 | Launch 2808 | Ambar 700 | Skiff | FRB |
| Hull Number | S 220 | 2805 | 2806 | 2807 | 2808 | 2302 | 1905 | 2301 |
| Call Letters | WTEB | | | | | | | |
| Manufacturer | Aerojet-General Shipyards | All American Marine | All American Marine | All American Marine | All American Marine | Marine Silverships, Inc | SeaArk | Zodiak of North America |
| Year of Construction | 1967 | 2009 | 2009 | 2009 | 2009 | 1998 | 2000 | 2004 |
| Type of Construction | Welded steel hull - ice strengthened | Welded Aluminum | Welded Aluminum | Welded Aluminum | Welded Aluminum | RHIB (Aluminum) | Welded Aluminum | RHIB (Fiberglass) |
| Length Overall | 70.4 m (231') | 8.64 m (28' 6") | 8.64 m (28' 6") | 8.64 m (28' 6") | 8.64 m (28' 6") | 7.0 m (23') | 5.79 m (19') | 6.7 m (22') |
| Beam | 12.8 m (42') | 3.48 m (11' 5") | 3.48 m (11' 5") | 3.48 m (11' 5") | 3.48 m (11' 5") | 2.9 m (9' 4") | 2.44 m (8') | 2.6 m (8' 6") |
| Draft | 4.7 m (15' 6") | 1.12 m (3' 8") | 1.12 m (3' 8") | 1.12 m (3' 8") | 1.12 m (3' 8") | 0.4 m (1' 4") | 0.66 m (26") | 0.6 m (22") |
| Cruising Speed | 12.5 knots | 24 knots | 24 knots | 24 knots | 24 knots | 22 knots | 25 knots | 18 knots |
| Max Survey Speed | 6 knots | 8 knots | 8 knots | 8 knots | 8 knots | | | |
| Date of Effective Full Vessel Static Offset Survey | Original Survey 9/23/2003 POS/MV Offsets Surveyed 2/2007 and 2/15/2009 | 1/26/2010 | 1/26/2010 | 1/27/2010 | 1/27/2010 | | | |
| Organization which Conducted the Effective Full Offset Survey | Original Survey - Westlake Consultants POS/MV Spatial Surveys - NGS | NGS/GSD | NGS/GSD | NGS/GSD | NGS/GSD | | | |
| Date of Last Partial Survey or Offset Verification & Methods Used | n/a | n/a | n/a | n/a | n/a | | | |
| Date of Last Static Draft Determination & Method Used | April-2010 Draft Marks | 3/8/2010 | 3/9/2010 | 2/4/2010 | 3/5/2010 | | | |
| Date of Last Settlement and Squat/Dynamic Draft Measurements & Method Used | 1/21/2010 Post Processed Kinematic (Ellipsoidally referenced) | 2/20/2010 Post Processed Kinematic (Ellipsoidally referenced) | 3/8/2010 Post Processed Kinematic (Ellipsoidally referenced) | 5/23/2010 Post Processed Kinematic (Ellipsoidally referenced) | 3/3/2010 Post Processed Kinematic (Ellipsoidally referenced) | | | |

Hydrographic Hardware Inventory

Field Unit: FAIRWEATHER

Effective Date: 3/25/2010

Updated Through: 8/9/2010

further investigation/information required in future

| SONAR & SOUNDING EQUIPMENT | | | | | | | | | | |
|----------------------------|--------------|---------------|---------------|--|------------------------------|------------------|--|---------------------------------------|--------------|---|
| Equipment Type | Manufacturer | Model | Serial Number | Firmware and/or Software Version | Version Install Date | Location | Date of last Field Cal/Testing | Date of last Manufacturer Cal/Service | Bar Code | Comments |
| Processor | RESON | 81-P (8160) | 35385 | Dry: 8160-2.09-7C6D Wet: 8160-1.00-E9E1 | May-2004 | S220-DP1 | N/A | | CD0001065313 | |
| Transducer | RESON | 8160 | unknown | N/A | installed in hull - April-04 | S220-hull | 5/8/2010 | installed in hull, 2004 | | |
| Tranceiver | RESON | 81-P (8160) | 35028 | | | S220-Conf Rm | N/A | | | P/N 85108021, RMA# 501210 |
| Processor | RESON | 71-P (7111) | 2009003 | TBD | | S220-DP1 | N/A | 10/6/2009 - Reson visit | CD0001065312 | P/N 85101802 |
| Transducer | RESON | 7111 | unknown | N/A | installed in hull - Oct-10 | S220-hull | 5/24/10, 7/14/10 Roll only | replaced transducer Mar-2009 | | |
| Tranceiver | RESON | 71-P (7111) | | | | S220-Conf Rm | N/A | Feb, May & July 2010 - Reson visits | | ngoing issues, see App IV-Corr. |
| Processor | RESON | 7125 SV | 1812028 | MR 7.1.1 | Jan-2010 | 2805 | 200 & 400kHz 3/8/2010 | | CD0001529714 | cal of transducers listed under processor |
| Processor | RESON | 7125 SV | 1812027 | MR 7.1.1 | Jan-2010 | 2806 | 200 & 400kHz 3/9/2010 | | CD0001529685 | P/N 85101812, cal of transducers listed under processor, vessel with loaner unit 2010 |
| Processor | RESON | 7125 SV | 1812020 | MR 7.1.1 | Jan-2010 | 2807 | 200 & 400kHz 4/21/2010 | | CD0001527818 | cal of transducers listed under processor |
| Processor | RESON | 7125 SV | 1812023 | MR 7.1.1 | Jan-2010 | 2808 | 200kHz 3/5/10, 400 3/5/10, & 400 4/5/10 PH | | CD0001529704 | cal of transducers listed under processor |
| 200 khz Projector | RESON | 200kHz (2163) | 2409098 | | Jan-2010 | TBD | | installed in hull, 2010 | | |
| 200 khz Projector | RESON | 200kHz (2163) | 4408351 | | Jan-2010 | TBD | | installed in hull, 2010 | | |
| 200 khz Projector | RESON | 200kHz (2163) | TBD | | Jan-2010 | TBD | | installed in hull, 2010 | | |
| 200 khz Projector | RESON | 200kHz (2163) | TBD | | Jan-2010 | TBD | | installed in hull, 2010 | | |
| 400 khz Projector | RESON | 400kHz (2160) | 2208007 | | Jan-2010 | TBD | | installed in hull, 2010 | | |
| 400 khz Projector | RESON | 400kHz (2160) | 2308110 | | Jan-2010 | TBD | | installed in hull, 2010 | | |
| 400 khz Projector | RESON | 400kHz (2160) | TBD | | Jan-2010 | TBD | | installed in hull, 2010 | | |
| 400 khz Projector | RESON | 400kHz (2160) | TBD | | Jan-2010 | TBD | | installed in hull, 2010 | | |
| Receiver | RESON | 7200/7216 | 309012 | | Jan-2010 | TBD | | installed in hull, 2010 | | |
| Receiver | RESON | 7200 | 309019 | | Jan-2010 | TBD | | installed in hull, 2010 | | |
| Receiver | RESON | 7200 | TBD | | Jan-2010 | TBD | | installed in hull, 2010 | | |
| Receiver | RESON | 7200 | TBD | | Jan-2010 | TBD | | installed in hull, 2010 | | |
| Processor | RESON | 81-P (8125) | 31562 | Dry: 8125-2.10-A50F Wet: 8125-1.08-9E98 | Unknown | DP3 | N/A | | CD0000825308 | Transferred to Mike Webb's Property (EEB) |
| Transducer | RESON | 8125 | 4400007 | N/A | Unknown | C02 | not installed | Unknown | | on loan from RUDE |
| Towfish | Klein | 5000 | 260 | N/A | | Spare, Boat Deck | | | | on loan from Bay Hydro til Sept-10 |
| Towfish | Klein | 5000 | 321 | | | 2805 | | | | |
| Towfish | Klein | 5000 | 293 | | | 2808 | | | CD0000825404 | initially testing 5/14/2009 |

| | | | | | | | | | | |
|-------------------------|---------------------------|-----------------------|---------------|--------------|-----|-------|---------------------------------|--------------------|--------------|---------------------------------------|
| TPU | Klein 5000 TPU | 5000 | 11937 | | | 2805 | | | CD0001722042 | PN: 12V-0320-TV05J12-P150-KA-1 |
| TPU | Klein 5000 TPU | 5000 | 117633 | | | 2808 | Readiness testing 04/06/2010 | | CD0001527021 | PN: 12V-0320-TV05J12-P150-KA-1 |
| TPU | Klein 5000 TPU | 5000 | 130144 | | | SPARE | | | CD0001527022 | PN: 12V-0320-TV05J12-P150-KA-1 |
| Processor | Odom Hydrographic Systems | Echotrac CVM-A | 26034 | Version 4.01 | | o lab | | new unit, May-2007 | CD0001703210 | ChartView Dongle (100.001.001.098) |
| Transducer (2) | Odom Hydrographic Systems | SMBB200-4A | TR5162/TR5159 | N/A | N/A | o lab | N/A | N/A | | Two 4 degree (large) |
| Transducer (2) | Odom Hydrographic Systems | SMBB200_9 | TR5138/TR5139 | N/A | N/A | o lab | N/A | N/A | | Two 9 degree (small) |
| Divers Least Depth Gaug | PTC | MODIII | 68337 | N/A | N/A | S220 | 4/22/2009 | 4/2/2008 | CD0001698256 | |
| Lead Line | FA Personnel | Traditional | 10_01_05 | N/A | N/A | any | 4/20/2009 | | | no bar code |
| Lead Line | FA Personnel | Traditional | 10_02_05 | N/A | N/A | any | 4/20/2009 | | | no bar code |
| Lead Line | FA Personnel | Traditional | 20_01_05 | N/A | N/A | any | 4/28/2009 | | | no bar code |
| Lead Line | FA Personnel | Traditional | 20_02_05 | N/A | N/A | any | 4/28/2009 | | | no bar code |
| Lead Line | FA Personnel | Traditional | 20_03_05 | N/A | N/A | any | 4/28/2009 | | | no bar code |
| Lead Line | FA Personnel | Traditional | 30_01_05 | N/A | N/A | any | 4/28/2009 | | | no bar code |
| Lead Line | FA Personnel | V-100/Non-Traditional | 10_05_09 | N/A | N/A | any | 4/28/2009 | | | no bar code |
| Lead Line | FA Personnel | V-100/Non-Traditional | 10_06_09 | N/A | N/A | any | | | | no bar code |
| | | | | | | | | | | work in progress |

POSITIONING & ATTITUDE EQUIPMENT

| Equipment Type | Manufacturer | Model | Serial Number | Firmware and/or Software Version | Version Install Date | Location | Date of last Field Cal/Testing | Date of last Manufacturer Cal/Service | Bar Code | Comments |
|---------------------|--------------|---------------|---------------|---|----------------------|--------------------------|--------------------------------|---------------------------------------|--------------|--|
| POS/MV PCS | Applanix | POS MV 320 V4 | 3627 | HW4.1-7, SW04.22 POS Cntrlr v. 4.3.4.0 | Jun-2008 | S220 IP:129.100.1.231 | 5/28/10 | | CD0001697462 | Auth. No. 811025-00534537 |
| POS/MV IMU | Applanix | LN200 | 292 | N/A | Apr-2004 | S220 | | | CD0001696450 | |
| POS MV Port Antenna | Trimble | Zephyr II | 1440904133 | | May-10 | S220 | | | | P/N 57970-00 DC 4911 On permanent loan from Rainer |
| POS MV Stbd Antenna | Trimble | Zephyr II | 31180200 | | May-10 | S220 | | | | P/N 57970-00 DC 4845 On permanent loan from Rainer |
| POS/MV PCS | Applanix | POS MV 320 V4 | 3628 | HW4.1-7, SW04.22 POS Cntrlr v. 4.3.4.0 | | 2805 | 2/20/10 | | CD0001527796 | Part # PCS-29 |
| POS/MV IMU | Applanix | LN200 | 294 | N/A | Jul-2003 | 2805 | | 2/1/2010 | CD0001696449 | part # 10001506-4 |
| POS MV Port Antenna | Trimble | Zephyr II | 31171727 | | | 2805 | Mar-09 | | no bar code | P/N: 57970-00 DC4905 |
| POS MV Stbd Antenna | Trimble | Zephyr II | 31185275 | | | 2805 | Feb-09 | | no bar code | P.N 57970-00 DC4905 |
| POS/MV PCS | Applanix | POS MV 320 V4 | 2564 | HW2.6-7, SW04.22 POS Cntrlr v. 4.3.4.0 | | 2806 | 3/8/10 | | CD0001601275 | no part no |
| POS/MV IMU | Applanix | LN200 | 324 | N/A | Feb-2007 | 2806 | | 2/2/2010 | CD0001722041 | part # 10001506-4 |
| POS MV Port Antenna | Trimble | Zephyr I | 30130644 | | | 2806 | | | no bar code | P/N: 39105-00 DC4804 |
| POS MV Stbd Antenna | Trimble | Zephyr I | 60078644 | | | 2806 | | | no bar code | P/N 39105-00 DC4521 |
| POS/MV PCS | Applanix | POS MV 320 V4 | 2560 | HW2.6-7, SW04.22 POS Cntrlr v. 4.3.4.0 | | 2807 | 4/21/10 | | CD0001601274 | no p/n |
| POS/MV IMU | Applanix | LN200 | 037 | | | 2807 | | TT 2007 (3/1/1998) | CD0000832907 | part # 10000978 |
| POS MV Port Antenna | Trimble | Zephyr II | 1440904832 | | | 2807 | Aug-09 | | no bar code | P/N: 57970-00 DC4911 |
| POS MV Stbd Antenna | Trimble | Zephyr II | 1440912566 | | | 2807 | Aug-09 | | no bar code | P/N 57970-00 DC4920 |
| POS/MV PCS | Applanix | POS MV 320 V4 | 2411 | HW2.9-7, SW04.22 POS Cntrlr v.4.3.4.0 | | 2808 | 3/4/10 | | CD0001697462 | no p/n |
| POS/MV IMU | Applanix | LN200 | 007 | | | 2808 | | TT 2007 (7/1996) | CD0000825306 | part # 10,000,978 |
| POS MV Port Antenna | Trimble | Zephyr II | 1440925095 | | | 2808 | Mar-09 | | no bar code | P/N: 39105-00 DC4604 |
| POS MV Stbd Antenna | Trimble | Zephyr II | 31171272 | | | 2808 | Mar-09 | | no bar code | P/N: 57970-00 DC4845 |

| | | | | | | | | | |
|-----------------------------------|-----------------|--------------------------------|-----------------|---------------------|----------|-----------------|--------|------------------|--|
| POS/MV IMU | Applanix | LN200 | 047 | | | | | CD0000825306 | removed from 2807 in April 2010 -assumed to be bad |
| POS/MV Port Antenna | Applanix | OEM2 3151R | 60103854 | HW1 | Feb-2007 | spare | | no bar code | ETs have as spares P/N 39105-00 DC 4602 |
| POS/MV Stbd Antenna | Applanix | OEM2 3151R | 60125191 | HW1 | Feb-2007 | spare | | no bar code | ETs have as spares P/N 39105-00 DC 4602 |
| POS/MV Stbd Antenna | Applanix | OEM2 3151R | 60145247 | HW1 | Mar-2007 | spare | | | removed from 1010 on 8/22/09 |
| POS/MV Port Antenna | Trimble | OEM2 3151R | 60145158 | N/A | Feb-2007 | spare | | 39105-00 DC 4618 | |
| POS/MV Port Antenna | Trimble | 39105-00 | 60268090 | N/A | Aug-2009 | spare | | | From new batch of 20 spares to be purchased by Larry Lowen- sent by Olivia |
| DGPS Receiver | CSI Wireless | MBX-3S | 0324-11969-0002 | N/A | Jul-2004 | S220 | | CD0001065375 | |
| DGPS Antenna | CSI Wireless | MGL3 | 9824-1779-0002 | N/A | Apr-2004 | S220 | | no bar code | |
| DGPS Receiver | Hemisphere | MBX-4 | 0927-9567-0001 | CDP004433 | | 2805 | | no bar code | P/N 801-3012-000# |
| DGPS Antenna | Hemisphere | MA40 | 0924-9488-0046 | | | 2805 | | no bar code | P/N 804-3029-000# |
| DGPS Receiver | Hemisphere | MBX-4 | 0923-9416-0005 | CDP004432 | | 2806 | | no bar code | P/N 801-3012-000# |
| DGPS Antenna | Hemisphere | MA40 | 0923-9416-0005 | | | 2806 | | no bar code | P/N 801-3012-000#C |
| DGPS Receiver | Hemisphere | MBX-4 | 0923-9416-0007 | | | 2807 | | no bar code | P/N 801-3012-000# |
| DGPS Antenna | Hemisphere | MA40 | 0919-9231-0191 | | | 2807 | | no bar code | P/N 804-3029-000# |
| DGPS Receiver | Hemisphere | MBX-4 | 09249498-007 | CDP004425 | | 2808 | | no bar code | P/N 801-3012-000# |
| DGPS Antenna | Hemisphere | MA40 | 0924-9488-0040 | | | 2808 | | no bar code | P/N 804-3029-000# |
| DGPS Receiver | CSI Wireless | MBX-3S | 0328-12362-0001 | N/A | Jul-2004 | ET Stores | | 10652291 | |
| DGPS Antenna | CSI Wireless | MGL3 | 0328-12352-0002 | N/A | Jul-2004 | ET Stores | | | |
| StarFire GPS Receiver | NavCom | SF-2050R | 5012 | | Jul-2008 | Plot Rm | 9/1/08 | CD0001697402 | P/N 92-310059, Net 1&2 capable only |
| StarFire GPS Receiver | NavCom | SF-2050R | 5086 | | | stored in O-lab | | CD0001699203 | thought to be Net 1 capable only |
| Trimble Backpack 1 | Trimble | Pathfinder Pro XRS | 0224078543 | Firmware v1.96 RevA | Mar-2008 | S220 | | CD0001269835 | |
| Trimble Backpack 1: Antenna | Trimble | 33580-50 | 0220341062 | N/A | N/A | S220 | | CD0001269835 | |
| Trimble Backpack 2 | Trimble | Pathfinder Pro XRS | 0224090101 | Firmware v1.96 RevA | Mar-2008 | S220 | | CD0001269836 | |
| Trimble Backpack 2: Antenna | Trimble | 33580-50 | 0220321059 | N/A | N/A | S220 | | | |
| Handheld data collector | Trimble | TSCe | 37318 | N/A | N/A | S220 | | no bar code | PN 45268-50 |
| Antenna cable | Trimble | | | | | S220 | | no bar code | P/N22628 |
| Camcorder Batteries | Trimble | | | | | S220 | | no bar code | P/N17466 |
| NMEA/RTCM cable | Trimble | | | | | S220 | | no bar code | P/N30232-00 |
| data/power cable | Trimble | | | | | S220 | | no bar code | P/N30231-00 |
| dual battery cable | Trimble | | | | | S220 | | no bar code | P/N24333 |
| GPS Pathfinder field device cable | Trimble | | | | | S220 | | no bar code | P/N45052 |
| Laser | Laser Tech Inc. | Impulse Laser Rangefinder | i09290 | N/A | N/A | S220 | | CD0001269812 | |
| Laser | Laser Tech Inc. | TruPulse 200 Laser Rangefinder | 001481 | N/A | N/A | S220 | | no bar code | no Bar Code |
| Laser | Laser Tech Inc. | TruPulse 200 Laser Rangefinder | 000676 | N/A | N/A | S220 | | no bar code | no Bar Code |

SOUND SPEED MEASUREMENT EQUIPMENT

| Equipment Type | Brooke Ocean Technology Inc. | Model | Serial Number | Firmware and/or Software Version | Version Install Date | Location | Date of last Field Cal/Testing | Date of last Manufacturer Cal/Service | Bar Code | Comments |
|--------------------------------|------------------------------|----------------------|---------------|----------------------------------|----------------------|----------------------------|--------------------------------|---------------------------------------|--------------|---|
| Moving Vessel Profiler winch | Brooke Ocean Technology Inc. | MVP-200-5 | 10328 | | | S220 | N/A | Apr-2009 | no bar code | Visit by BOT tech Darrell Groom |
| Moving Vessel Profiler fish | Brooke Ocean Technology Inc. | MVP-FFF-SS-32-1 | 10478 | | | S220 | N/A | Apr-2009 | no bar code | Visit by BOT tech Darrell Groom, primary fish |
| Moving Vessel Profiler fish | Brooke Ocean Technology Inc. | MVP-FFF-SS-32-1 | 10329 | | | S220 | N/A | Apr-2009 | no bar code | Visit by BOT tech Darrell Groom, spare fish |
| Moving Vessel Profiler sensor | Applied Micro Systems Ltd. | AML Smart SV +P | 4986 | | | stored in server room | DQAs weekly if in service | 3/2/2010 | | spare |
| Moving Vessel Profiler sensor | Applied Micro Systems | AML Smart SV +P | 5229 | | | S220 | DQAs weekly | 1/7/2010 | | installed in primary fish |
| Moving Vessel Profiler sensor | Applied Micro Systems Ltd. | AML Smart SV +P | 5466 | | | stored in server room | DQAs weekly if in service | 3/2/2010 | | spare |
| SEACAT Profiler | Sea-Bird | SBE 19plus | 19P36026-4585 | 1.4D | | S220 | DQAs weekly | 12/7/2009 | CD0001697254 | CON file: 4585.con |
| SEACAT Profiler | Sea-Bird | SBE 19plus | 19P36026-4616 | 1.4D | | 2805 | DQAs weekly | 12/7/2009 | CD0001697264 | CON file: 4616.con |
| SEACAT Profiler | Sea-Bird | SBE 19plus | 19P36026-4617 | 1.4D | | 2806 | DQAs weekly | 12/7/2009 | CD0001697251 | CON file: 4617.con |
| SEACAT Profiler | Sea-Bird | SBE 19plus V2 | 19P50959-6121 | 2.1 | | 2807 | DQAs weekly | 12/3/2009 | CD0001527777 | CON file: 6121.con |
| SEACAT Profiler | Sea-Bird | SBE 19plus V2 | 19P50959-6122 | 2.1 | | 2808 | DQAs weekly | 12/7/2009 | CD0001527778 | CON file: 6122.con |
| Sound Velocity Probe | RESON | SVP-71 | 2008027 | | Jan-2010 | 2805 | DQAs weekly | installed in hull, 2010 | | |
| Sound Velocity Probe | RESON | SVP-71 | 2008024 | | Jan-2010 | 2806 | DQAs weekly | installed in hull, 11/30/2009 | | |
| Sound Velocity Probe | RESON | SVP-71 | 2008038 | | Jan-2010 | 2807 | DQAs weekly | installed in hull, 2010 | | |
| Sound Velocity Probe | RESON | SVP-71 | 2008017 | | Jan-2010 | 2808 | DQAs weekly | installed in hull, 10/09/2009 | | |
| Real Time Sound Speed Profiler | RESON | SVP 70 | 4008077 | | | S220 | DQAs weekly | 1/4/2009 | | |
| Real Time Sound Speed Profiler | Odom Hydrographic Systems | Digibar Pro/ DB 1200 | 98207 | SW 1.11 | | Goes with 8125 Loc. in C02 | DQAs weekly | 4/16/2009 | | Previous S/N listed: 98013-041609 |

TIDES & LEVELING EQUIPMENT

| Equipment Type | Manufacturer | Model | Serial Number | Firmware and/or Software Version | Version Install Date | Location | Date of last Field Cal/Testing | Date of last Manufacturer Cal/Service | Bar Code | Comments |
|----------------|--------------|---------|---------------|----------------------------------|----------------------|------------------------------------|--------------------------------|---------------------------------------|-------------|----------|
| Level | Carl Zeiss | N12 333 | 100056 | N/A | N/A | stored in O-lab, when not in field | Mar-2009 | Mar-2008 | no bar code | |
| Level | Carl Zeiss | N12 333 | 103267 | N/A | N/A | stored in O-lab, when not in field | Mar-2009 | Mar-2008 | no bar code | |
| Level | Leica | NA2 100 | 5332739 | N/A | N/A | stored in O-lab | | | no bar code | Spare |
| Level | Lecia | NA2 100 | 5332747 | N/A | N/A | stored in O-lab | | | no bar code | Spare |

HORIZONTAL AND VERTICAL CONTROL EQUIPMENT

| Equipment Type | Manufacturer | Model | Serial Number | Firmware and/or Software Version | Version Install Date | Location | Date of last Field Cal/Testing | Date of last Manufacturer Cal/Service | Bar Code | Comments |
|-------------------|--------------|-------------------|------------------|----------------------------------|----------------------|--------------|--------------------------------|---------------------------------------|--------------|---------------------|
| GPS Receiver | Trimble | NetR5 | 4910K61066 | 4.03 | Apr-2009 | stored O-lab | Apr-2009 | obtained Apr-2009 | CD0001526972 | used in field |
| GPS Antenna | Trimble | Zephyr Geodetic 2 | 30767996 | | | stored O-lab | Apr-2009 | obtained Apr-2009 | no Bar Code | used in field |
| GPS Receiver | Trimble | NetR5 | 4910K61054 | 4.03 | Apr-2009 | stored O-lab | Apr-2009 | obtained Apr-2009 | CD0001526973 | used in field |
| GPS Antenna | Trimble | Zephyr Geodetic 2 | 30767941 | | | stored O-lab | Apr-2009 | obtained Apr-2009 | no Bar Code | used in field |
| GPS Receiver | Ashtech | Z-Xtreme | ZE1200339016 | ZE21 | Mar-2008 | stored O-lab | Apr-2009 | obtained Apr-2004 | CD0001062363 | used in field |
| GPS Antenna | Ashtech | Geodetic 4 | 8365 | | | stored O-lab | Apr-2009 | obtained Apr-2004 | No Barcode | used in field |
| UHF Radio | FreeWave | HTP-900RE | 884-8978 | 2.17 | Mar-2009 | S220 | | obtained Mar-2009 | CD0001526970 | |
| UHF Radio | FreeWave | HTP-900RE | 884-9190 | 2.17 | Mar-2009 | S220 | | obtained Mar-2009 | CD0001526971 | |
| UHF Radio | FreeWave | HTP-900RE | 884-9511 | 2.17 | May-2009 | S220 | | obtained May-2009 | no Bar Code | |
| UHF Radio | FreeWave | HTP-900RE | 884-9301 | 2.17 | May-2009 | S220 | | obtained May-2009 | no Bar Code | |
| UHF Radio | FreeWave | HTP-900RE | 885-8740 | 6.5P | | 2805 | | | | |
| UHF Radio | FreeWave | HTP-900RE | 885-8156 | 6.5P | | 2806 | | | | |
| UHF Radio | FreeWave | HTP-900RE | 885-8689 | 6.5P | | 2807 | | | | |
| UHF Radio | FreeWave | HTP-900RE | 885-8141 | 6.5P | | 2808 | | | | |
| UHF Antenna | PCTEL | MAX9053 | | | | S220 | | obtained May-2009 | no Bar Code | |
| UHF Antenna | PCTEL | MAX9053 | | | | stored O-lab | | obtained May-2009 | no Bar Code | used in field |
| UHF Antenna | PCTEL | MAX9053 | | | | stored O-lab | | obtained May-2009 | no Bar Code | used in field |
| UHF Antenna | PCTEL | MAX9053 | | | | stored O-lab | | obtained May-2009 | no Bar Code | spare |
| Solar Charger | PWM | EPRC5 | | | | stored O-lab | | obtained May-2009 | no Bar Code | used in field |
| Solar Charger | PWM | EPRC5 | | | | stored O-lab | | obtained May-2009 | no Bar Code | used in field |
| Solar Charger | PWM | EPRC5 | | | | stored O-lab | | obtained May-2009 | no Bar Code | spare |
| Solar Panel | Uni-Solar | FLX-32 | USF-32-14639 | N/A | N/A | stored O-lab | | | no Bar Code | used in field |
| Solar Panel | Uni-Solar | FLX-32 | USF-32-14634 | N/A | N/A | stored O-lab | | | no Bar Code | used in field |
| Solar Panel | Uni-Solar | FLX-32 | USF-32-14633 | N/A | N/A | stored O-lab | | | no Bar Code | used in field |
| Solar Panel | Uni-Solar | FLX-32 | USF-32-14529 | N/A | N/A | stored O-lab | | | no Bar Code | used in field |
| Solar Panel | Uni-Solar | FLX-32 | USF-32-14631 | N/A | N/A | stored O-lab | | | no Bar Code | used in field |
| Solar Panel | Uni-Solar | FLX-32 | USF-32-14625 | N/A | N/A | stored O-lab | | | no Bar Code | used in field |
| Solar Panel | Uni-Solar | MBC-525 | 525-011590 | N/A | N/A | stored O-lab | | | CD000684513 | used in field |
| Solar Panel | Uni-Solar | MBC-526 | 525-011093 | N/A | N/A | stored O-lab | | | CD000684507 | used in field |
| Solar Panel | Uni-Solar | MBC-527 | 525-011589 | N/A | N/A | stored O-lab | | | CD000684510 | used in field |
| Solar Panel | Uni-Solar | MBC-528 | 525-011607 | N/A | N/A | stored O-lab | | | CD000684512 | used in field |
| Solar Panel | Uni-Solar | MBC-529 | 525-011587 | N/A | N/A | stored O-lab | | | CD000684511 | used in field |
| Solar Panel | GE Energy | GEPV-030-MNA | C30G200506210062 | N/A | N/A | stored O-lab | | | no Bar Code | used in field |
| Solar Panel | GE Energy | GEPV-030-MNA | C30G200506210063 | N/A | N/A | stored O-lab | | | no Bar Code | used in field |
| Solar Panel | GE Energy | GEPV-030-MNA | C30G200506210075 | N/A | N/A | stored O-lab | | | no Bar Code | used in field |
| Solar Panel | GE Energy | GEPV-030-MNA | C30G200506210076 | N/A | N/A | stored O-lab | | | no Bar Code | used in field |
| Solar Panel | Uni-Solar | FLX-32 | USF-32-14645 | N/A | N/A | destroyed | | | no Bar Code | gone- eaten by bear |
| Solutions Dongles | Ashtech | 600586 (A) | KEB2083 | N/A | N/A | stored S220 | | | no Bar Code | |
| Solutions Dongles | Ashtech | 600586 (A) | KEB2077 | N/A | N/A | stored S220 | | | no Bar Code | |

ADDITIONAL POSITIONING EQUIPMENT

| Equipment Type | Manufacturer | Model | Serial Number | Firmware and/or Software Version | Version Install Date | Location | Date of last Field Cal/Testing | Date of last Manufacturer Cal/Service | Bar Code | Comments |
|---|---------------|------------------------------|---------------|----------------------------------|----------------------|----------|--------------------------------|---------------------------------------|----------------|---------------------------|
| GPS RTK Receiver | Trimble | DSM-232 | 225111661 | 3.57 | Mar-2008 | C02 | | | CD0001697439 | RTK capable |
| GPS Receiver | Trimble | DSM-232RS | 225111655 | 3.57 | Mar-2008 | C02 | | | CDCD0001697422 | not upgradable |
| DGPS Antenna | Trimble | 33580-00 | 220395038 | N/A | N/A | C02 | | | no Bar Code | |
| GPS Antenna | Trimble | Zephyr Geodetic Antenna | 30325441 | N/A | N/A | C02 | | | no Bar Code | |
| GPS Antenna | Trimble | SPS MSK | 5876 | N/A | N/A | C02 | | | no Bar Code | |
| GPS RTK Reciver | Trimble | MS 750 | 220339262 | | | C02 | | | CD 0001478898 | RTK capable |
| GPS Antenna | Trimble | Trimble Micro Centered L1/L2 | 220298707 | N/A | N/A | C02 | | | no Bar Code | NOAA Launch Barcode A2008 |
| Position Data Link High Powered Base Unit | Pacific Crest | PDL 4135 | 0424 0171 | 2.40 | Apr-2004 | C02 | 5/3/2007 | obtained Apr-2004 | CD0001269910 | |
| Position Data Link Rover | Pacific Crest | PDL 4100 | 04240154 | 2.4 | Apr-2004 | C02 | 5/3/2007 | obtained Apr-2004 | CD0001269896 | |
| Position Data Link Rover | Pacific Crest | PDL 4100 | 03473047 | 2.32 | Apr-2004 | C02 | 5/3/2007 | obtained Apr-2004 | CD0001269912 | |
| Position Data Link Rover | Pacific Crest | PDL 4100 | 04240155 | 2.4 | Apr-2004 | C02 | 5/3/2007 | obtained Apr-2004 | CD0001269911 | |
| Position Data Link Rover | Pacific Crest | PDL 4101 | 07095939 | | | C02 | | | no Bar Code | |

OTHER EQUIPMENT

| Equipment Type | Manufacturer | Model | Serial Number | Firmware and/or Software Version | Version Install Date | Location | Date of last Field Cal/Testing | Date of last Manufacturer Cal/Service | Bar Code | Comments |
|-------------------------|------------------------------|-------------------|---------------|----------------------------------|----------------------|-----------|--------------------------------|---------------------------------------|--------------|-----------------------|
| 8-Port Gigabit Switch | Lynksys | SRW2008 | RMQ00J700285 | | | 2805 | | | P004422 | |
| 8-Port Gigabit Switch | Lynksys | SRW2008 | RMQ00J700115 | | | 2806 | | | P004421 | |
| 8-Port Gigabit Switch | Lynksys | SRW2008 | | | | 2807 | | | no bar code | |
| 8-Port Gigabit Switch | Lynksys | SRW2008 | RMQ00J700119 | | | 2808 | | | P004424 | |
| Hard Drive Dock | Nexstar | | | | | 2805 | | | no bar code | |
| Hard Drive Dock | Nexstar | | | | | 2806 | | | no bar code | |
| Hard Drive Dock | Nexstar | | | | | 2807 | | | no bar code | |
| Hard Drive Dock | Nexstar | | | | | 2808 | | | no bar code | |
| Penetrometer | Brooke Ocean Technology Inc. | FFCPT-35-2 | 10416 | | | S220 | | | | |
| Penetrometer sensor | Brooke Ocean Technology Inc. | AML SV +P | 191-3 | | | S220 | | | | |
| Micro Thermosalinograph | Sea-Bird | SBE 45 (TSG) | 4536628-0117 | N/A | N/A | S220 | Jul-2009 | 1/8/2008 | | P/N 4536628 |
| GPS Antenna | Furno | GPA-019S | 21299 | N/A | | S220 | | | no bar code | for bridge equipment? |
| Processor | Klein | Sonar Workstation | | Sonar Pro 11.3 | | ET stores | | | CD0000825155 | not being utilized |
| Processor | Klein | Sonar Workstation | | | | ET stores | | | CD0000825148 | not being utilized |

FAIRWEATHER Computers

| Machine Name | Location | Make/Model | Operating System | Date Purchased | Date of Last Rebuild | Processor Speed | RAM (original) | RAM (checked on date) | Number of Video Outputs | Video RAM | Service Tag | Barcode | Comments |
|---------------------------|--------------|-----------------------|------------------|----------------|----------------------|-----------------|----------------|-----------------------|-------------------------|-----------|----------------|--------------|---|
| FA_Proc_1 | Plot Room | Dell Precision T3400 | XP Pro 2002 SP3 | Summer-09 | | 3.33 GHz | 3 GB | | 2 | 512 MB | HG7LWK1 | CD0001766763 | New Dell desktop installed March 2010 |
| FA_Proc_2 | Plot Room | Dell Precision T3400 | XP Pro 2002 SP3 | Summer-09 | | 3.33 GHz | 3 GB | | 2 | 512 MB | DJKBZK1 | CD0001766913 | New Dell desktop installed March 2010 |
| FA_Proc_3 | Plot Room | Dell Precision T3400 | XP Pro 2002 SP3 | Summer-09 | | 3.33 GHz | 3 GB | | 2 | 512 MB | 7G7CWK1 | CD0001766754 | New Dell desktop installed March 2010 |
| FA_Proc_4 | Plot Room | Dell Precision T3400 | XP Pro 2002 SP3 | Summer-09 | | 3.33 GHz | 3 GB | | 2 | 512 MB | GZ55K1 | CD0001766791 | New Dell desktop installed March 2010 |
| FA_Proc_5 | Plot Room | Dell Precision 490 | XP Pro 2002 SP3 | Nov-07 | | 2.66 GHz | 3 GB | | 2 | 256 MB | 3MP1PD1 | CD0001615381 | Dell desktop installed week of 12/4/07 |
| FA_Proc_6 | Plot Room | Dell Precision T3400 | XP Pro 2002 SP3 | Summer-09 | | 3.33 GHz | 3 GB | | 2 | 512 MB | JG7CWK1 | CD0001766764 | New Dell desktop installed March 2010 |
| FA_Proc_7 | Plot Room | Dell Precision T3400 | XP Pro 2002 SP3 | Summer-09 | | 3.33 GHz | 3 GB | | 2 | 512 MB | 1H7CWK1 | CD0001766765 | New Dell desktop installed March 2010 |
| FA_Proc_8 | Plot Room | Dell Precision T3400 | XP Pro 2002 SP3 | Apr-08 | | 3.0 GHz | 3 GB | | 2 | 512 MB | 5JKCZF1 | CD0001615467 | Dell desktop installed week of 04/14/08 |
| FA_Proc_9 | Plot Room | Dell Precision T3400 | XP Pro 2002 SP3 | Apr-08 | | 3.0 GHz | 3 GB | | 2 | 512 MB | 3JKCZF1 | CD0001615472 | Dell desktop installed week of 04/06/08 |
| FA_Proc_10 | Plot Room | Dell Precision T3400 | XP Pro 2002 SP3 | Apr-08 | | 3.0 GHz | 3 GB | | 2 | 512 MB | TJKCZF1 | CD0001615471 | Dell desktop installed week of 04/06/08, Not installed as of 6/3/10 |
| FA_CST | Field Office | Dell Precision T3400 | XP Pro 2002 SP3 | Apr-08 | | 3.0 GHz | 3 GB | | 2 | 512 MB | 4JKCZF1 | CD0001615469 | Dell desktop installed week of 04/06/08 |
| FA_FOO | Field Office | Dell Precision T3400 | XP Pro 2002 SP3 | Apr-08 | | 3.0 GHz | 3 GB | | 2 | 512 MB | DHKCZF1 | CD0001615470 | Dell desktop installed week of 04/06/08 |
| FA_O-Lab | O-Lab | Dell Precision 490 | XP Pro 2002 SP3 | Nov-07 | | 2.66 GHz | 3 GB | | 2 | 256 MB | 2NP1PD1 | CD0001615380 | Dell desktop installed week of 12/4/07, Moved 03/2010 |
| FA_P2_Proc_1 | Plot Room 2 | Dell Precision T3400 | XP Pro 2002 SP3 | Apr-08 | | 3.0 GHz | 3 GB | | 2 | 512 MB | JHKCZF1 | CD0001615468 | Dell desktop installed week of 04/06/08 |
| FA_P3_Proc_1 | Plot Room 3 | Dell Precision T3400 | XP Pro 2002 SP3 | Summer-09 | | 3.33 GHz | 3 GB | | 2 | 512 MB | FJKBZK1 | CD0001766914 | New Dell desktop installed March 2010 |
| FA_P3_Proc_2 | Plot Room 3 | Dell Precision 490 | XP Pro 2002 SP3 | Nov-07 | | 2.66 GHz | 3 GB | | 2 | 256 MB | 8MP1PD1 | CD0001615384 | Dell desktop installed week of 12/4/07, Moved 03/2010 |
| FA_P3_Proc_3 | Plot Room 3 | Dell Precision 490 | XP Pro 2002 SP3 | Nov-07 | | 2.66 GHz | 3 GB | | 2 | 256 MB | 9MP1PD1 | CD0001615385 | Refreshed 02/2010, 12/4/07, Moved 03/2010 |
| FA_P3_Proc_4 | Plot Room 3 | Dell Precision T3400 | XP Pro 2002 SP3 | Summer-09 | | 3.33 GHz | 3 GB | | 2 | 512 MB | HZ55ZK1 | CD0001766792 | New Dell desktop installed March 2010 |
| Toughbook 1 | Laptop | Panasonic CF-18 | XP Pro 2002 SP2 | ~ March 2004 | ~ July 2006 | 1.1 GHz | 2.5 GB | | 1 | 64 MB | 4HKSA59499 | CD0001269860 | rebuilt after crash July 2006 -, whereabouts unknown |
| Toughbook 2 | Laptop | Panasonic CF-18 | XP Pro 2002 SP2 | ~ March 2004 | ~ September 2005 | 1.1 GHz | 2.5 GB | | 1 | 64 MB | 4HKSA59560 | CD0001269858 | |
| Toughtab 1 | Laptop | Panasonic CF-18 | XP Pro 2002 SP2 | ~ March 2004 | ~ September 2005 | 1.1 GHz | 2.5 GB | | 1 | 64 MB | 4GKSA55049 | CD0001269859 | transferred to Engineering dept, April 2010 |
| Toughbook 3 | Laptop | Panasonic CF-29 | XP Pro 2002 SP2 | March 2006 | | 1.6 GHz | 2.5 GB | | 1 | 128 MB | 6AKSB06863 | CD0001698251 | |
| Toughbook 4 | Laptop | Panasonic CF-30 | XP Pro 2002 SP3 | March 2009 | | 1.7 GHz | 1 Gb | | 0 | 384 MB | 8HKSB80630 | CD0001447100 | |
| Toughbook 6 | Laptop | Panasonic CF-30 | XP Pro 2002 SP3 | March 2009 | | 1.7 GHz | 1 Gb | | 0 | 384 MB | 8HKSB80631 | CD0001447101 | |
| Toughbook 5 | Laptop | Panasonic CF-19 | XP Pro 2002 SP3 | March 2009 | | 1.1 GHz | 1 Gb | | 1 | 384 MB | 9AKSB43281 | CD0001696424 | Previously listed as CD0001698316 |
| Survey Mobile Workstation | Laptop | Dell Precision M4400 | XP Pro 2002 SP3 | | | 3.0 GHz | 3.5 Gb | | 1 | 512 MB | 8L56ZK1 | CD0001766841 | |
| 2805_ACQ | Launch 2805 | Cybertron PC ACP-4000 | XP Pro 2002 SP3 | | | 2.0 GHz | 3 GB | | 2 | 1024 MB | 40001000160709 | CD0001703148 | P/N ACP-4000MB-00XE |
| 2806_ACQ | Launch 2806 | Cybertron PC ACP-4000 | XP Pro 2002 SP3 | | | 2.0 GHz | 3 GB | | 2 | 1024 MB | 40001000160707 | CD0001703147 | P/N ACP-4000MB-00XE |
| 2807_ACQ | Launch 2807 | Cybertron PC ACP-4000 | XP Pro 2002 SP3 | | | 2.0 GHz | 3 GB | | 2 | 1024 MB | 40001000160711 | CD0001703146 | P/N ACP-4000MB-00XE |
| 2808_ACQ | Launch 2808 | Cybertron PC ACP-4000 | XP Pro 2002 SP3 | | | 2.0 GHz | 3 GB | | 2 | 1024 MB | 40001000160708 | CD0001703149 | P/N ACP-4000MB-00XE |
| S220_ACQ | Plot Room | Dell Precision T3400 | XP Pro 2002 SP2 | Mar-08 | | 3.0 GHz | 3 GB | | 3 | 512 MB | CSH8NF1 | CD0001269854 | |
| FA_MVP200 | Plot Room | MVP-C1-2001 | 2000 SP4 | ~ March 2004 | ~ September 2005 | 2.4 GHz | 230 MB | | 1 | 64 MB | SN: 10330 | | (CD# Not found) Listed previously as S220_ACQ CD# CD0001615444(?) 11/18 |

Appendix II

Vessel Reports, Offsets, and Diagrams

Launch 2805

1. Offsets
2. Patch Test
3. Dynamic Draft

Launch 2806

1. Offsets
2. Patch Test
3. Dynamic Draft

Launch 2807

1. Offsets
2. Patch Test
3. Dynamic Draft

Launch 2808

1. Offsets
2. Patch Test
3. Dynamic Draft

S220

1. Offsets
2. Patch Test
3. Dynamic Draft

Coordinate Systems Utilized in Vessel Offsets

Reference Surface Comparison

SSS and MBES Dual Acquisition Report

2805 Offsets and Measurements - Summary

| Measurement aka | IMU to RP* | IMU to 7125 <i>SWATH1 x,y,z & MRU to Trans</i> | Port Ant to 7125 <i>Nav to Trans x,y,z</i> | RP* to Waterline | Port Ant to Stbd Ant | IMU to Port Ant | IMU to Heave |
|-----------------|------------|---|---|------------------|-----------------------|-----------------|--------------|
| Coord. Sys. | Caris | Caris | Caris | Caris | | Caris Pos/Mv | Caris Pos/Mv |
| x | 0.000 | 0.004 | 0.686 | n/a | Scaler Distance 1.447 | -0.682 | 0.000 |
| y | 0.000 | 0.245 | 1.051 | n/a | | -0.806 | 0.000 |
| z | 0.000 | 0.482 | 3.656 | -0.111 | | -3.174 | 0.000 |

*IMU is Reference Point

Vessel Offsets for 2805 7125 are derived from the NGS Survey, January 2010, Trimble Equipment Specs, a 2010 Measured Values.

Calculations

| Coord. Sys./ Source | IMU to 7125 | Port Ant to 7125 | RP to Waterline | Port Ant to Stbd Ant | IMU to Port Ant | IMU to Heave |
|---------------------|--|--|---|--|---|--|
| NGS | IMU (m) x 0.00000 y 0.00000 z 0.00000 | IMU to x -0.68217 Port Ant (m) y -0.80598 (calculated) z 3.17407 | RP to Waterline (m) (waterline z 0.111 worksheet) | IMU to x -0.68217 Port Ant (m) y -0.80598 (calculated) z 3.17407 | IMU (m) x 0.00000 y 0.00000 z 0.00000 | IMU (m) x 0.00000 y 0.00000 z 0.00000 |
| MBES RP | x 0.00401 | IMU to 7125 x 0.00401 | | IMU (m) x, y, z 0.00000 | Top of x -0.68217 | Heave Pt (m) x 0.00000 |
| Rcvr - Phase Center | (m) y 0.24503 z -0.48191 | Phase Ctr y 0.24503 (calculated) z -0.48191 | | Top of x 0.76454 Stbd Ant (m) y -0.80778 z 3.14528 | Port Ant (m) y -0.80598 z 3.16277 | (by design) y 0.00000 z 0.00000 |
| | | | | Base to top of Stbd Ant (eqp spec) (m) z 0.073 | Base to top of Port Ant (eqp spec) (m) z 0.073 | |
| | | | | Bottom of Stbd Ant (calculated) (m) z 3.07228 | Bottom of Port Ant (calculated) (m) z 3.08977 | |
| | | | | Base to Phase Cntr of Stbd Ant (eqp spec) (m) z 0.0843 | Base to Phase Cntr of Port Ant (eqp spec) (m) z 0.0843 | |

| Coord. Sys. | IMU to 7125 | Port Ant to 7125 | RP to Waterline | Port Ant to Stbd Ant | IMU to Port Ant | IMU to Heave |
|-------------------|--|---|--|------------------------|---|--|
| NGS | IMU to 7125 x 0.00401 Phase Ctr y 0.24503 z -0.48191 | x 0.68618 y 1.05101 z -3.65598 | x n/a y n/a z 0.111 | Scalar Distance 1.4468 | x -0.68217 y -0.80598 z 3.17407 | x 0.00000 y 0.00000 z 0.00000 |
| Coord. Sys. CARIS | x 0.00401 y 0.24503 z 0.48191 | Coord. Sys. CARIS x 0.68618 y 1.05101 z 3.65598 | Coord. Sys. CARIS x n/a y n/a z -0.111 | | Coord. Sys. Pos/Mv x -0.80598 y -0.68217 z -3.17407 | Coord. Sys. Pos/Mv x 0.00000 y 0.00000 z 0.00000 |

Description of Offsets for Launch 2805

All Values Shown are in CARIS Coordinates

The Ship Reference Frame (SRF) for Launch 2805 was based from the IMU reference point as the 0,0,0 point. Physical locations were measured with x,y,z offsets from this point. These locations were used to calculate offsets of items with respect to each other, as described for each offset.

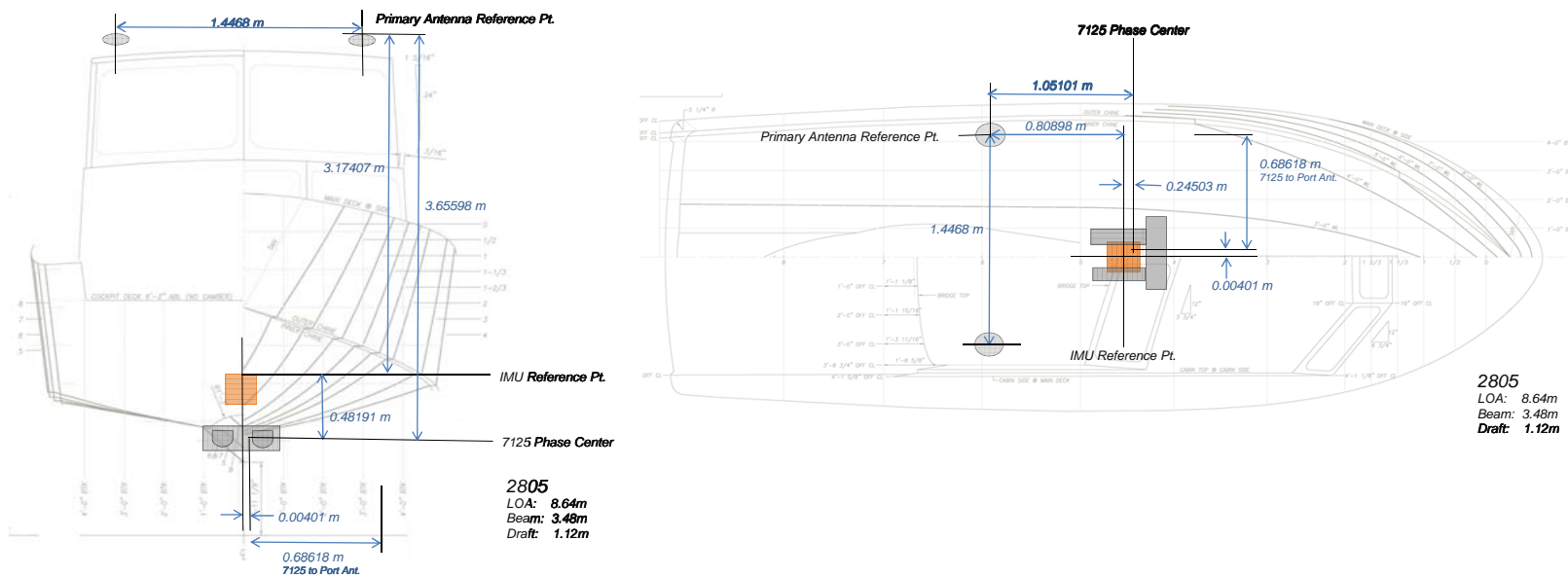

| IMU to 7125 | | |
|-------------|-------|-------|
| x | y | z |
| 0.004 | 0.245 | 0.482 |

The physical positions of the IMU and the phase center of the 8101 with respect to the Ship Reference Frame were measured by NOAA personnel. These physical measurements were used to calculate the xyz offsets from the IMU to BM H. Measurements from BM H to the Phase Center of the 8101 were collected by NOAA personnel while the boat was secured on the pier and thought to be as level as possible. The measured offsets from BM H to the phase center were then added to the offset from the IMU to BM H. The result is the offset from the IMU to the phase center of the transducer. The values in the X and Y fields are transposed and the inverse of the Z value is used to give the offsets in CARIS coordinates.

| Port Ant to 7125 | | |
|------------------|-------|-------|
| x | y | z |
| 0.686 | 1.051 | 3.656 |

NOAA personnel calculated the distance between the port antenna and the phase center of the port antenna subtracting the IMU to Port Antenna value from the IMU to Phase Center value.

| RP to Waterline | | |
|-----------------|-----|--------|
| x | y | z |
| N/A | N/A | -0.111 |

The average vertical distance from Port Benchmark to waterline and the Starboard Benchmark to the waterline were measured by FAIRWEATHER personnel using a steel tape and bubble level. These values were combined with the Z value of the Benchmarks to the RP/IMU to get an average for the waterline to RP. The Waterline Measurement value is in NGS coordinates initially and is converted to CARIS coordinates.

| Port Ant to Stbd Ant |
|----------------------|
| Scalar Distance |
| 1.447 |

The location of the phase center of the port and starboard POS/MV antennas were surveyed by NGS. The z-values were adjusted to the phase center. Then the scalar distance between the phase centers was calculated.

| IMU to Port Antenna | | |
|---------------------|--------|--------|
| x | y | z |
| -0.682 | -0.806 | -3.174 |

The location of the IMU and the location of the top of port antenna were surveyed by NGS. The z-value of the antenna was calculated by subtracting the height of the antenna and then adding the value from the base of the antenna to the phase center of the antenna. The calculation results were then transposed from the NGS to the CARIS coordinate system.

| IMU to Heave | | |
|--------------|-------|-------|
| x | y | z |
| 0.000 | 0.000 | 0.000 |

The Heave Point is assumed to coincide with the IMU location.

Waterline Measurements

Measuring Party: **Beduhn, Loy, Floyd, Brooks**

2805

Waterline measurements should be negative and cm!

| | 2805 | |
|-----------|-----------------------------|-----------------------------|
| | Port Benchmark to Waterline | Stbd Benchmark to Waterline |
| Measure 1 | -95.0 | -94.9 |
| Measure 2 | -94.8 | -94.8 |
| Measure 3 | -94.8 | -94.3 |
| Avg (cm) | -94.87 | -94.67 |
| Avg (m) | -0.9487 | -0.9467 |

Stdev 0.00115 0.00321

BM Z-value (m)* 1.07535 1.04250

BM to WL (m) 0.127 0.096

Individual measurement 0.12535 0.09350

StDev for TPU xls 0.017035 0.12735 0.09450

(of 6 #s) 0.09950

Fill in Yellow squares only!

Date: 3/8/2010

Fuel Level: 5/8 Full

Draft Tube:

Port-to-Stbd Z-difference

| Theoretical | Actual | Error |
|-------------|--------|---------|
| 0.0329 | 0.0020 | -0.0309 |

RP to WL Average (m)

0.111 NGS Coordinate System (do not enter into CARIS directly)
(Add this value to VSSL_Offsets & Measurements_20XX.xls)

utilized in Offsets and Measurements and TPU spreadsheet

Measuring Party: **Floyd, Loy, Brooks, Beduhn**

2805

Waterline measurements should be negative and cm!

| | 2805 | |
|-----------|-----------------------------|-----------------------------|
| | Port Benchmark to Waterline | Stbd Benchmark to Waterline |
| Measure 1 | -96.0 | 97.9 |
| Measure 2 | -96.5 | -97.3 |
| Measure 3 | -94.1 | -97.2 |
| Avg (cm) | -95.53 | -32.20 |
| Avg (m) | -0.9553 | -0.3220 |

Stdev 0.01266 1.12670

BM Z-value (m) 1.07535 1.04250

BM to WL (m) 0.120016667 0.721

Individual measurement 0.11535 2.02150

StDev for TPU xls 0.784869 0.11035 0.06950

(of 6 #s) 0.07050

Date: 3/9/2010

Fuel Level: 1/2 Full

Draft Tube:

Port-to-Stbd Z-difference

| Theoretical | Actual | Error |
|-------------|--------|--------|
| 0.0329 | 0.6333 | 0.6005 |

RP to WL Average (m)

0.420 NGS Coordinate System (do not enter into CARIS directly)
(or add this value to VSSL_Offsets & Measurements_20XX)

Measuring Party: **Jaskoski, Loy, Nardi, Andvick**

2805

Waterline measurements should be negative and cm!

| | 2805 | |
|-----------|-----------------------------|-----------------------------|
| | Port Benchmark to Waterline | Stbd Benchmark to Waterline |
| Measure 1 | -97.0 | -97.7 |
| Measure 2 | -97.2 | -97.9 |
| Measure 3 | -97.2 | -98.2 |
| Avg (cm) | -97.13 | -97.93 |
| Avg (m) | -0.9713 | -0.9793 |

Stdev 0.00115 0.00252

BM Z-value (m) 1.07535 1.04250

BM to WL (m) 0.104 0.063

Individual measurement 0.10535 0.06550

StDev for TPU xls 0.022443 0.10335 0.06350

(of 6 #s) 0.06050

Date: 4/1/2010

Fuel Level: 1/3 full 43.4 gal

Draft Tube:

Port-to-Stbd Z-difference

| Theoretical | Actual | Error |
|-------------|---------|---------|
| 0.0329 | -0.0080 | -0.0409 |

RP to WL Average (m)

0.084 NGS Coordinate System (do not enter into CARIS directly)
(or add this value to VSSL_Offsets & Measurements_20XX)

US DEPARTMENT OF COMMERCE
NATIONAL OCEANIC & ATMOSPHERIC ADMINISTRATION
NATIONAL OCEAN SERVICE
NATIONAL GEODETIC SURVEY
GEODETIC SERVICES DIVISION
INSTRUMENTATION & METHODOLOGIES BRANCH

**NOAA SURVEY VESSEL 2805
POS MV COMPONENTS SPATIAL RELATIONSHIP
SURVEY
FIELD REPORT**

Kendall L. Fancher
January, 2010



**NOAA SURVEY VESSEL 2805
POS MV COMPONENTS SPATIAL RELATIONSHIP SURVEY**

PURPOSE

The primary purpose of the survey was to precisely determine the spatial relationship between various hydrographic surveying sensors, launch bench marks and the components of a POS MV navigation system aboard the NOAA survey vessel 2805.

PROJECT DETAILS

This survey was conducted in Seattle, WA at the NOAA Western Center on the 26th of January, 2010. The weather was sunny early then cloudy with temperatures in the 40s to 50s. For this survey, the vessel was on blocks, supported by boat jacks. The vessel was reported to have been leveled relative to the IMU.

INSTRUMENTATION

A Leica TDA5005 precision total station was used to make all measurements.

Technical Data:

| Standard Deviation | |
|----------------------|-------------|
| Horizontal angle | 0.5 seconds |
| Vertical angle | 0.5 seconds |
| Distance measurement | 1mm + 1ppm |

Leica precision prisms were used as sighting targets. Prisms were configured to have a zero mm offset.

PERSONNEL

Kendall Fancher NOAA/NOS/NGS/GSD/I&M BRANCH
(540) 373-1243
kendall.fancher@noaa.gov

Dennis Lokken NOAA/NOS/NGS/GSD/I&M BRANCH
(540) 373-1243
dennis.lokken@noaa.gov

**NOAA SURVEY VESSEL 2805
POS MV COMPONENTS SPATIAL RELATIONSHIP SURVEY**

DEFINITION OF THE REFERENCE FRAME

For this survey, data was collected in a 3-D right handed Cartesian coordinate system. The origin of this coordinate system is defined as the center of the IMU target. The Y (Northing) axis is parallel to the centerline of the launch and is positive towards the bow of the launch. The X (Easting) axis is perpendicular to the Y axis and is positive towards the starboard side of the launch. The Z (Elevation) axis is perpendicular to the XY plane and is positive towards the top of the launch. The coordinates of the points established this survey are reported in this coordinate system and are provided in Appendix A.

SURVEY METHODOLOGY

Four temporary control points, (1, 2, 3, and 4), were established around the vessel such that every point to be positioned on the launch could be observed from at least two separate locations.

Coordinates of 100.000N, 100.000E, and 100.000U were assumed for temporary control point 1. A distance and height difference were measured between control points 1 and 2. Temporary control point 2 was assumed to have an Easting of 100.000. The measured distance between these two points was used to determine the Northing for temporary control point 2. The height difference between the two points was used to determine the Up component for control point 2.

Control point 1 was occupied and control point 2 was observed to initialize the instrument. After initialization, control point 4 and all visible points to be observed on the launch were observed in both direct and reverse. The stability of the instrument setup was checked at conclusion of the data set collection by checking back to temporary control point 2.

Control point 2 was occupied and control point 1 was observed to initialize the instrument. After initialization, control point 3 and all visible points to be observed on the launch were observed in both direct and reverse. The stability of the instrument setup was checked at conclusion of the data set collection by checking back to temporary control point 1.

Control point 3 was occupied and control point 2 was observed to initialize the instrument. After initialization, control point 4 and all visible points to be observed on the launch were observed in both direct and reverse. The stability of the instrument setup was checked at conclusion of the data set collection by checking back to temporary control point 2.

NOAA SURVEY VESSEL 2805 POS MV COMPONENTS SPATIAL RELATIONSHIP SURVEY

Control point 4 was occupied and control point 3 was observed to initialize the instrument. After initialization, all visible points to be observed on the launch were observed in both direct and reverse. Control point 1 was also observed in order to evaluate the accuracy of the traverse. Inverse computations between the original and observed control point yielded a horizontal accuracy, or traverse closure of 0.000m and a vertical accuracy of 0.000m. The stability of the instrument setup was checked at conclusion of the data set collection by checking back to temporary control point 2.

Inverses were computed between the two positions determined for all points surveyed to evaluate their accuracy relative to the temporary control network. Inverse reports are included in appendix B.

The reference frame was rotated using CENTERLINE STERN BM (CLS) as the point of rotation. A zero degree azimuth was used during the rotation from CLS to CENTERLINE BOW BM (BMB). The reference frame was then translated to relocate the origin of the reference frame to the IMU.

DISCUSSION

The positions given for the POS GPS antennas (Zephyr Model II p/n 57970-00) are to the top center of the antenna. To correct the Z value provided in this report for each antenna to the electronic phase center, I recommend the following steps be taken;

- 1) Determine the physical height of the GPS antenna. This information is probably located on the antenna or with equipment documentation.
- 2) Investigate to find the electronic phase center offset of the antenna. This information is probably located on the antenna or with equipment documentation. This value may also be available at the NGS website for antenna modeling.
- 3) Subtract the total height of the antenna from the Z value for each antenna. This will give you a Z value for the antenna ARP (antenna reference point)
- 4) Then add to this value the electronic phase center offset value appropriate for the antenna model.



NOAA SURVEY VESSEL 2805 POS MV COMPONENTS SPATIAL RELATIONSHIP SURVEY

Two reference points (MBF and MBA) were positioned in order to facilitate future measurements to the Multi-Beam sensor by launch personnel. These reference points are punch marks set along the center of the keel, at the locations described in the image at right.



A point on the Multi-Beam transducer (MB) was measured directly this survey. The measured point was at the center of the bottom of the transducer. No mark was left to indicate the measured point.

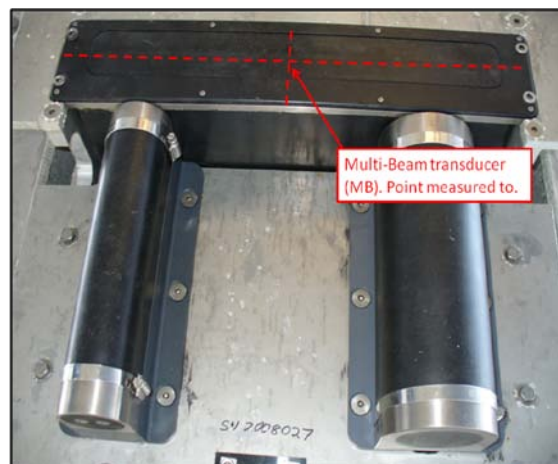

The point positioned for the Inertial Motion Unit (IMU) this survey was the center of the target affixed to the top of the unit. Additionally, a reference mark (IMUR) was established on the plate the IMU is attached to at a point where two scribed lines intersect, forward of the IMU.

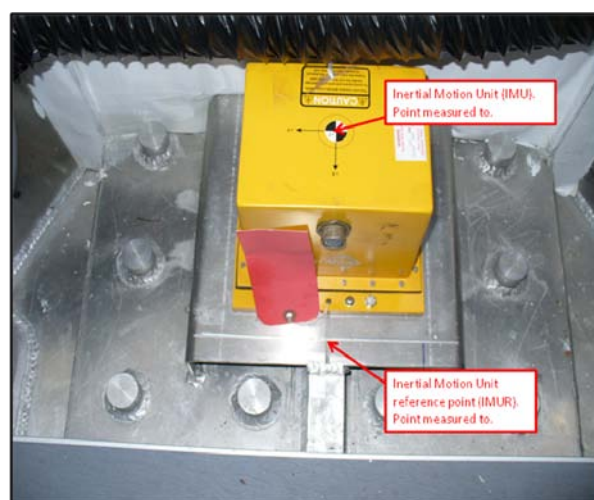

**NOAA SURVEY VESSEL 2805
POS MV COMPONENTS SPATIAL RELATIONSHIP SURVEY**

STATION LISTING

| | |
|-------|---|
| BMB- | CENTERLINE BOW BM The center of a cross mark inscribed into the top of a square metal flange, welded to the deck, along the centerline and near the bow of the launch. |
| CLS- | CENTERLINE STERN BM The center of a cross mark inscribed into the top of a square metal flange, welded to the deck, along the centerline and near the stern of the launch. |
| BMC- | CENTERLINE CAB BM The center of a cross mark inscribed into the top of a square metal flange, welded to the top of the cab, along the centerline of the launch. |
| BMP- | PORT SIDE BM The center of a cross mark inscribed into the top of a square metal flange, welded to the top of the deck, near the middle of and along the port side of the launch. |
| BMS- | STARBOARD SIDE BM The center of a cross mark inscribed into the top of a square metal flange, welded to the top of the deck, near the middle of and along the starboard side of the launch. |
| MBF- | KEEL BM A punch mark set along the bottom center of the keel, fore of the multi-beam transducer, 0.030 m from a point where the keel makes a 90 degree angle upwards. |
| MBA- | KEEL BM A punch mark set along the bottom center of the keel, aft of the multi-beam transducer, 0.030 m from a point where the keel makes a 90 degree angle upwards. |
| IMU- | IMU TARGET Center of a target affixed to the top of the IMU housing. |
| IMUR- | IMU REFERENCE BM The intersection of two scribed lines atop a metal support plate for the IMU and forward of the IMU. |
| GPSP- | PORT SIDE GPS ANTENNA REFERENCE POINT The top center of the port side GPS antenna for the POS system. |
| GPSS- | STARBOARD GPS ANTENNA REFERENCE POINT The top center of the starboard side GPS antenna for the POS system. |
| MB- | MULTI-BEAM REFERENCE POINT The physical bottom center of the Multi-Beam transducer. |

Appendix A

Coordinate Report Launch 2805

| <i>Pt Name</i> | <i>North(Y)</i> | <i>East(X)</i> | <i>Elev.(Z)</i> | <i>ID</i> |
|-------------------------------|-----------------|----------------|-----------------|-----------|
| IMU Target | 0.00000 | 0.00000 | 0.00000 | IMU |
| IMU Reference BM | 0.13270 | -0.00348 | -0.16937 | IMUR |
| Centerline Stern BM | -4.04803 | 0.01735 | 0.67574 | CLS |
| Centerline Bow BM | 3.46914 | 0.01735 | 1.39751 | BMB |
| Portside GPS Ant. Ref. Point | -0.80598 | -0.68217 | 3.16277 | GPSP |
| Starboard GPS Ant. Ref. Point | -0.80778 | 0.76454 | 3.14528 | GPSS |
| Multi-Beam Ref.Point | 0.24503 | 0.00401 | -0.48191 | MB |
| Keel BM | 0.44007 | -0.00202 | -0.61410 | MBF |
| Keel BM | -0.22895 | -0.00227 | -0.53363 | MBA |
| Port Side BM | 0.10603 | -1.42637 | 1.07535 | BMP |
| Starboard Side BM | 0.10926 | 1.45859 | 1.04250 | BMS |
| Centerline Cab BM | -0.19024 | 0.03192 | 2.65903 | BMC |

Units = meters

Appendix B

Point to Point Inverse Launch 2805

| <i>Pt. 1</i> | <i>Pt. 2</i> | <i>Dist.</i> | <i>Northing</i> | <i>Easting</i> | <i>Elevation</i> | <i>ID</i> |
|--------------|--------------|--------------|-----------------|----------------|------------------|-----------|
| 18 | 31 | 0.004 | -0.003 | 0.003 | -0.00141 | BMC |
| 9 | 29 | 0.001 | 0.001 | - 0.001 | 0.00051 | BMP |
| 39 | 49 | 0.003 | -0.003 | 0.001 | -0.00063 | BMS |
| 8 | 48 | 0.001 | -0.001 | -0.001 | 0.00016 | CLS |
| 10 | 30 | 0.002 | -0.001 | 0.002 | 0.00033 | GPSP |
| 11 | 41 | 0.000 | 0.000 | 0.000 | 0.00034 | GPSS |
| 16 | 53 | 0.001 | 0.000 | 0.001 | 0.00024 | IMU |
| 17 | 54 | 0.002 | 0.000 | 0.002 | 0.00029 | IMUR |
| 4 | 46 | 0.006 | 0.005 | 0.002 | -0.00018 | MB |
| 5 | 47 | 0.001 | 0.000 | 0.001 | 0.00016 | MBA |
| 3 | 45 | 0.002 | 0.001 | 0.001 | -0.00017 | MBF |

Units = meters

FAIRWEATHER

Multibeam Echosounder Calibration

Launch 2805 200kHz

Vessel

SST Beduhn, AST Moehl, CST Morgan, LT Welton, LTJg Arnold

Calibrating Hydrographer(s)

| | | |
|-------------------|----------------------|---------------------------------------|
| Reson 7125 200kHz | Launch 2805 | 01/01/2010 |
| MBES System | MBES System Location | Date of most recent EED/Factory Check |

| | |
|---------------------|-------------------------------|
| TBD | CD0001529714 |
| Sonar Serial Number | Processing Unit Serial Number |

| | |
|------------------------------|---|
| Plate mounted on hull | 01/26/2010 |
| Sonar Mounting Configuration | Date of current offset measurement/verification |

| | |
|-----------------------------------|--|
| DGPS Beacon 323, POSMV V4 | 02/20/2010 |
| Description of Positioning System | Date of most recent positioning system calibration |

Acquisition Log

| | | | |
|----------|-----|------------|----|
| 3/8/2010 | 067 | Shilshole | |
| Date | Dn | Local Area | Wx |

| | |
|-------------|-------------------------|
| Bottom Type | Approximate Water Depth |
|-------------|-------------------------|

Loy, Floyd, Brooks, Beduhn

Personnel on board

all speeds six knots unless otherwise noted

Comments

2010_067_2805.000

TrueHeave filename

| | | | | | |
|---------------------|-------------|-------------|--------------|-------|------------|
| 100671857 | 18:44:00 PM | 47 40 34.89 | 122 25 22.26 | 40 | 47.7 |
| SV Cast #1 filename | UTC Time | Lat | Lon | Depth | Ext. Depth |

| | | | | | |
|---------------------|----------|-------------|--------------|-------|------------|
| 100672227 | 22:27 | 47 40 31.25 | 122 25 27.03 | 40 | 46.3 |
| SV Cast #2 filename | UTC Time | Lat | Lon | Depth | Ext. Depth |

Processing Log

3/10/2010 | | Beduhn
 Date Dn Personnel

Data converted --> HDCS_Data in CARIS

TrueHeave applied 2009_064_2808.000

SVP applied 2010_064_2808.000

Tide applied N395RA2009.tc predicted

Zone file _____

Lines merged

Data cleaned to remove gross fliers

Compute correctors in this order

1. Precise Timing 2. Pitch bias 3. Heading bias 4. Roll bias

Do not enter/apply correctors until all evaluations are complete and analyzed.

PATCH TEST RESULTS/CORRECTORS

| Evaluators | Latency (sec) | Pitch (deg) | Roll (deg) | Yaw (deg) |
|---------------------------|---------------|-------------|------------|-----------|
| SST Beduhn | 0.00 | -0.89 | -0.49 | 0.85 |
| AST Moehl | 0.00 | -0.75 | -0.47 | 0.75 |
| CST Morgan | 0.00 | -0.85 | -0.47 | 0.80 |
| LT Welton | 0.00 | -0.80 | -0.48 | 1.10 |
| LTjg Arnold | 0.00 | -0.68 | -0.43 | 1.03 |
| | | | | |
| | | | | |
| | | | | |
| Averages | 0.00 | -0.79 | -0.47 | 0.91 |
| Standard Deviation | 0.00 | 0.08 | 0.02 | 0.15 |
| FINAL VALUES | 0.00 | -0.79 | -0.47 | 0.91 |

Final Values based on Averages

Resulting HVF File Name FA_2805_200kHz_Rsn7125_256bms_2010

MRU Align StdDev gyro 0.15 Value from standard deviation of Heading offset values
MRU Align StdDev Roll/Pitch 0.05 Value from averaged standard deviations of pitch and roll offset values

NARRATIVE

HVF Hydrographic Vessel File created or updated with current offsets

Name: CST/FOO

Date: 3/30/2010

FAIRWEATHER

Multibeam Echosounder Calibration

Launch 2805 400kHz

Vessel

CST Morgan, LT Welton, SST Beduhn, Ltjg Arnold

Calibrating Hydrographer(s)

| | | |
|-----------------------------------|----------------------|--|
| Reson 7125 400kHz | Launch 2805 | 01/01/2010 |
| MBES System | MBES System Location | Date of most recent EED/Factory Check |
| TBD | | CD0001529714 |
| Sonar Serial Number | | Processing Unit Serial Number |
| Plate mounted on hull | | 01/26/2010 |
| Sonar Mounting Configuration | | Date of current offset measurement/verification |
| DGPS Beacon 323, POSMV V4 | | 2/20/2010 |
| Description of Positioning System | | Date of most recent positioning system calibration |

Acquisition Log

| | | | |
|----------|-----|------------|----|
| 3/8/2010 | 067 | Shilshole | |
| Date | Dn | Local Area | Wx |

| | | | |
|-------------|--|--|-------------------------|
| | | | |
| Bottom Type | | | Approximate Water Depth |

Loy, Floyd, Brooks, Beduhn

Personnel on board

All lines run 6-6.5 kts unless otherwise noted

Comments

2010_067_2805.000

TrueHeave filename

| | | | | |
|---------------------|--------------|--------------|-------|------------|
| 100671857 | 147 40 34.89 | 122 25 22.26 | 40 | 47.7 |
| SV Cast #1 filename | U Lat | Lon | Depth | Ext. Depth |

| | | | | |
|---------------------|-------------|--------------|-------|------------|
| 100672227 | 47 40 31.25 | 122 25 27.03 | 40 | 46.3 |
| SV Cast #2 filename | U Lat | Lon | Depth | Ext. Depth |

view parallel to track, one line with induced roll (outerbeam) or same lines bounded slope (nadir)
[same direction, different speed]

NAV TIME LATENCY

| SV Cast # | XTF Line Filename | Heading | Speed (kts) | Remarks |
|-----------|-------------------|---------|-------------|----------------------|
| | 2153 | 235 | 6ish | Line 1, induced roll |
| | 2155 | 060 | | induced roll |
| | | | | |
| | | | | |
| | | | | |
| | | | | |
| | | | | |
| | | | | |

PITCH view parallel to track, same line (at nadir) [opposite direction, same speed]

| SV Cast # | XTF Line Filename | Heading | Speed (kts) | Remarks |
|-----------|-------------------|---------|-------------|------------|
| | 2159 | 135 | | Line # 103 |
| | 2201 | 317 | | |
| | 2202 | 138 | | |
| | 2204 | 316 | | |
| | | | | |
| | | | | |
| | | | | |
| | | | | |
| | | | | |

HEADING/YAW view parallel to track, offset lines (outerbeams) [opposite direction, same speed]

| SV Cast # | XTF Line Filename | Heading | Speed (kts) | Remarks |
|-----------|-------------------|---------|-------------|---------|
| | 2205 | 129 | | |
| | 2206 | 311 | | |
| | 2207 | 126 | | |
| | 2208 | 305 | | |
| | | | | |
| | | | | |
| | | | | |
| | | | | |
| | | | | |

ROLL view across track, same line [opposite direction, same speed]

| SV Cast # | XTF Line Filename | Heading | Speed (kts) | Remarks |
|-----------|-------------------|---------|-------------|---------------|
| | 2210 | 057 | | |
| | 2213 | 237 | | |
| | 2215 | 060 | | |
| | 2218 | 240 | | |
| | | | | |
| | 2221 | 061 | 7ish | Roll Stab Off |
| | 2223 | 235 | | Roll Stab Off |
| | | | | |

Processing Log

3/10/2010 | | Beduhn
 Date | Dn | Personnel

- Data converted --> HDCS_Data in CARIS
- TrueHeave applied 2009_064_2808.000
- SVP applied 2010_064_2808.000
- Tide applied N395RA2009.tc predicted
- Zone file _____
- Lines merged
- Data cleaned to remove gross fliers

Compute correctors in this order

1. Precise Timing
 2. Pitch bias
 3. Heading bias
 4. Roll bias

Do not enter/apply correctors until all evaluations are complete and analyzed.

PATCH TEST RESULTS/CORRECTORS

| Evaluators | Latency (sec) | Pitch (deg) | Roll (deg) | Yaw (deg) |
|---------------------------|---------------|-------------|------------|-----------|
| CST Morgan | 0.00 | -1.00 | -0.27 | 0.90 |
| LT Welton | 0.00 | -1.04 | -0.29 | 0.97 |
| SST Beduhn | 0.00 | -1.00 | -0.27 | 0.94 |
| LT(jg) Arnold | 0.00 | -1.00 | -0.20 | 0.93 |
| | | | | |
| | | | | |
| | | | | |
| | | | | |
| | | | | |
| | | | | |
| Averages | 0.00 | -1.01 | -0.26 | 0.94 |
| Standard Deviation | 0.00 | 0.02 | 0.04 | 0.03 |
| FINAL VALUES | 0.00 | -1.01 | -0.26 | 0.94 |

Final Values based on Averages

Resulting HVF File Name FA_2805_400kHz_Rsn7125_512bms_2010

MRU Align StdDev gyro 0.03 Value from standard deviation of Heading offset values
 MRU Align StdDev Roll/Pitch 0.03 Value from averaged standard deviations of pitch and roll offset values

NARRATIVE

- HVF Hydrographic Vessel File created or updated with current offsets
- Name: CST/FOO Date: 03/30/2010

***Fairweather* Launch 2805 Dynamic Draft Measurement Lake Washington, 20 February 2010**

LTjg Caryn Arnold, HSTP West Coast Field Support Liaison

On Saturday, 20 February 2010 (DN 051), *Fairweather* Launch 2805 conducted a dynamic draft measurement (DDM) on Lake Washington using post processed kinematic GPS data. The vessel sat at rest for approximately 5 minutes, then ran in the North direction at approximate speeds of 4, 6, 8 and 10 knots, holding each speed for about 4 minutes. The vessel then turned around and ran in the South direction at approximate speeds of 10, 8, 6 and 4 knots, again holding each speed for about 4 minutes and resting for approximately 5 minutes at the end. The POS/MV recorded a POSpac file the entire time from beginning rest to finish rest.

The POSpac file was processed with POSpac MMS Software using the GNSS-Inertial Processing Single Base Station Mode. The single CORS station SEAI (1 Hz) was chosen as the base station. The Lever Arm Standard Deviation was set to <3cm and then the GNSS-Inertial Processor in the Forward, Backward and Combine mode was Run.

The file was then exported out from the POSpac MMS software with an output rate of 1 sec and run through the Python Script written by LTjg Glen Rice, which includes the fourth order polynomial curve. The following graphs were generated.

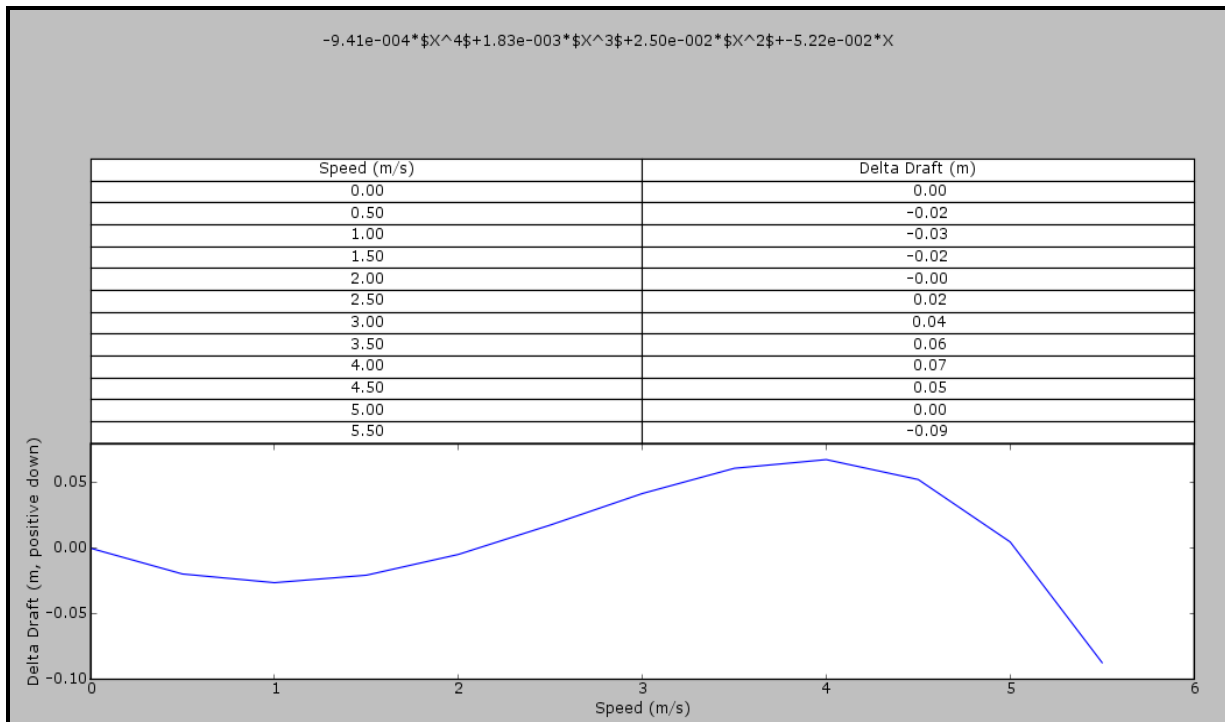

Figure 1. *Fairweather* Launch 2805 Inverted Dynamic Draft Curve & Computed Dynamic Draft Table for Caris

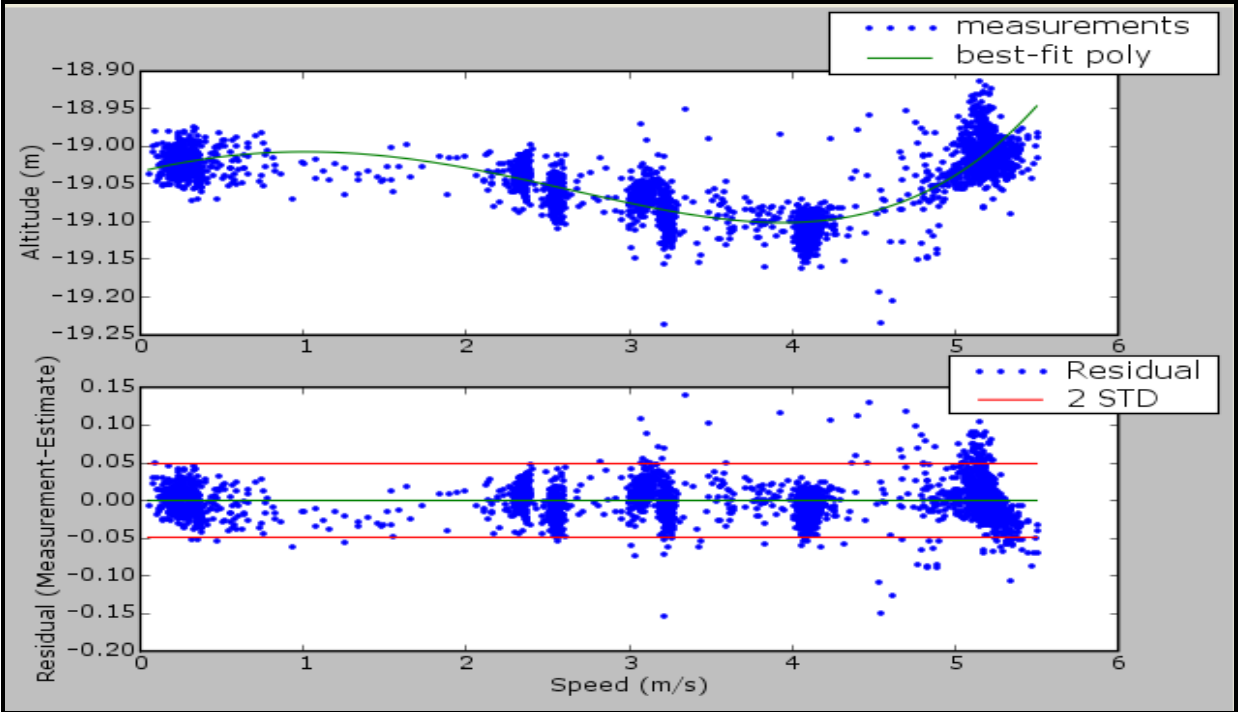

Figure 2. *Fairweather* Launch 2805 Dynamic Draft Curve with Data Points

2806 Offsets and Measurements - Summary

| Measurement aka | IMU to RP* | IMU to 7125 (Receiver) SWATH1 x,y,z & MRU to Trans | Port Ant to 7125 Nav to Trans x,y,z | RP* to Waterline | Port Ant to Stbd Ant | IMU to Port Ant | IMU to Heave |
|-----------------|------------|---|--|------------------|-----------------------|-----------------|--------------|
| Coord. Sys. | Caris | Caris | Caris | Caris | | Caris Pos/Mv | Caris Pos/Mv |
| x | 0.000 | -0.013 | 0.624 | n/a | Scaler Distance 1.448 | -0.637 | 0.000 |
| y | 0.000 | 0.254 | 1.087 | n/a | | -0.832 | 0.000 |
| z | 0.000 | 0.481 | 3.617 | -0.105 | | -3.136 | 0.000 |

*IMU is Reference Point

Vessel Offsets for 2808 7125 are derived from the NGS Survey, January 2010, Trimble Equipment Specs, 2010 Measured Values.

Calculations

| Coord. Sys./ Source | IMU to 7125 | Port Ant to 7125 | RP to Waterline | Port Ant to Stbd Ant | IMU to Port Ant | IMU to Heave |
|---------------------|--|--|---|---|---|--|
| NGS | IMU (m) x 0.00000 y 0.00000 z 0.00000 | IMU to x -0.63695 Port Ant (m) y -0.83249 (calculated) z 3.13638 | RP to Waterline (m) (waterline z 0.105 worksheet) | IMU to x -0.63695 Port Ant (m) y -0.83249 (calculated) z 3.13638 | IMU (m) x 0.00000 y 0.00000 z 0.00000 | IMU (m) x 0.00000 y 0.00000 z 0.00000 |
| | MBES RP Rcvr - Phase (m) Center x -0.01284 y 0.25447 z -0.48083 | IMU to x -0.01284 Phase Ctr y 0.25447 (calculated) z -0.48083 | | IMU (m) x, y, z 0.00000 Top of Stbd Ant (m) x 0.81062 y -0.82526 z 3.10821 | Top of Port Ant (m) x -0.63695 y -0.83249 z 3.14938 | Heave Pt (m) x 0.00000 (by design) y 0.00000 z 0.00000 |
| | | | | Base to top of Stbd Ant (measured) (m) z 0.059 Bottom of Stbd Ant (calculated) (m) z 3.04921 Base to Phase Cntr of Stbd Ant (eqp spc) (m) z 0.046 | Base to top of Port Ant (measured) (m) z 0.059 Bottom of Port Ant (calculated) (m) z 3.09038 Base to Phase Cntr of Port Ant (eqp spc) (m) z 0.046 | |
| Coord. Sys. NGS | IMU to x -0.01284 Phase Ctr y 0.25447 z -0.48083 | Port Ant to 7125 x 0.62411 y 1.08696 z -3.61721 | RP to Waterline x n/a y n/a z 0.105 | Port Ant to Stbd Ant Scalar Distance 1.4482 | IMU to Port Ant x -0.63695 y -0.83249 z 3.13638 | IMU to Heave x 0.00000 y 0.00000 z 0.00000 |
| | Coord. Sys. CARIS x -0.01284 y 0.25447 z 0.48083 | Coord. Sys. CARIS x 0.62411 y 1.08696 z 3.61721 | Coord. Sys. CARIS x n/a y n/a z -0.105 | | Coord. Sys. Pos/Mv x -0.83249 y -0.63695 z -3.13638 | Coord. Sys. Pos/Mv x 0.00000 y 0.00000 z 0.00000 |

Description of Offsets for Launch 2806

All Values Shown are in CARIS Coordinates

The Ship Reference Frame (SRF) for Launch 2806 was based from the IMU reference point as the 0,0,0 point. Physical locations were measured with x,y,z offsets from this point. These locations were used to calculate offsets of items with respect to each other, as described for each offset.

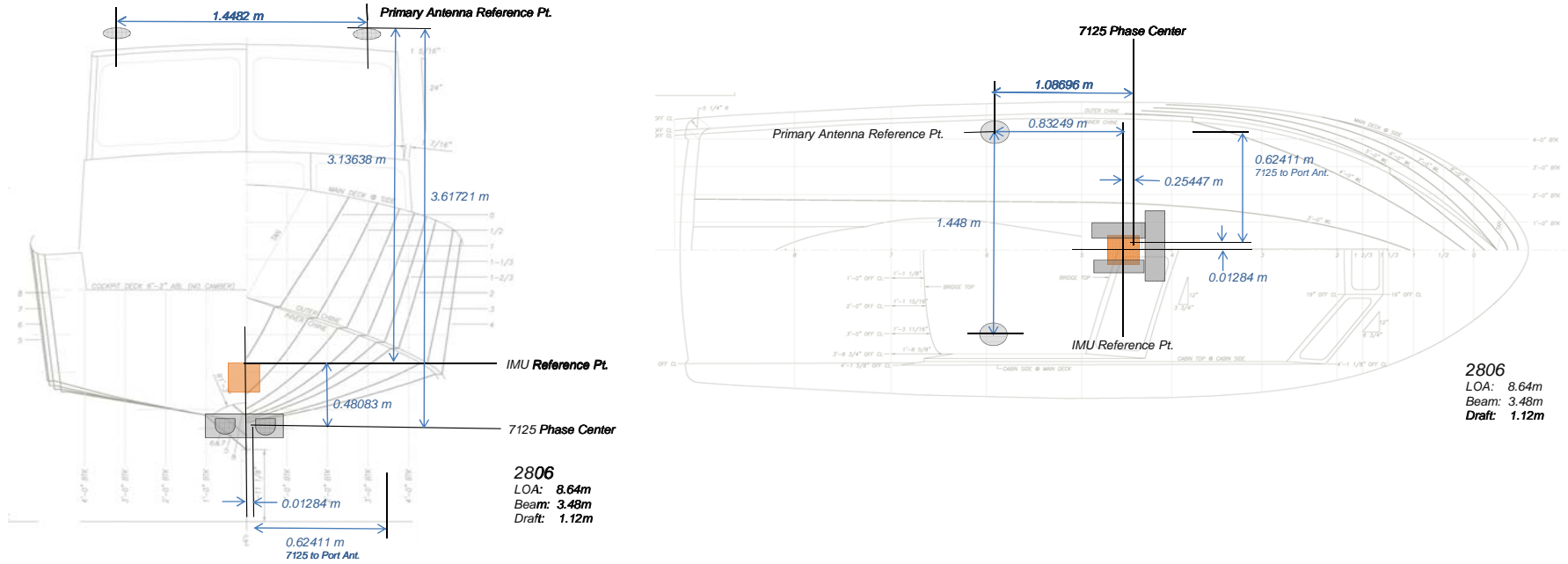

2806
 LOA: 8.64m
 Beam: 3.48m
 Draft: 1.12m

| IMU to 7125 | | |
|-------------|-------|-------|
| x | y | z |
| -0.013 | 1.087 | 3.617 |

The physical positions of the IMU and the receiver phase center of the 7125 were measured during the NGS survey. These physical measurements were taken while the launch was secured on the pier and thought to be as level as possible. The measured values for the IMU and MB were taken directly for the report. The difference is the offset from the IMU to the phase center of the 7125 which was then transposed from the NGS to the CARIS coordinate system.

| Port Ant to 7125 | | |
|------------------|-------|-------|
| x | y | z |
| 0.624 | 1.087 | 3.617 |

The values were calculated by subtracting the of the Port Antenna to the IMU x, y, z values from the respective values of the IMU to the 7125. The calculated values were then transposed from the NGS to the CARIS coordinate system.

| RP to Waterline | | |
|-----------------|-----|--------|
| x | y | z |
| n/a | n/a | -0.105 |

The average vertical distance from Port Benchmark to waterline and the Starboard Benchmark to the waterline were measured by FAIRWEATHER personnel using a steel tape and bubble level. These values were combined with the Z value of the Benchmarks to the RP/IMU to get an average for the waterline to RP. The Waterline Measurement value is in NGS coordinates initially and is converted to CARIS coordinates.

| Port Ant to Stbd Ant |
|----------------------|
| Scalar Distance |
| 1.448 |

The location of the phase center of the port and starboard POS/MV antennas were surveyed by NGS. The z-values were adjusted to the phase center. Then the scalar distance between the phase centers was

| IMU to Port Antenna | | |
|---------------------|--------|--------|
| x | y | z |
| -0.637 | -0.832 | -3.136 |

The location of the IMU and the location of the top of port antenna were surveyed by NGS. The z-value of the antenna was calculated by subtracting the height of the antenna and then adding the value from the base of the antenna to the phase center of the antenna. The calculation results were then transposed from the NGS to the CARIS coordinate system.

| IMU to Heave | | |
|--------------|-------|-------|
| x | y | z |
| 0.000 | 0.000 | 0.000 |

The Heave Point is assumed to coincide with the IMU location.

Waterline Measurements

Measuring Party: Beduhn, Wozumi, Phunt, Allen
2806

Waterline measurements should be negative and cm!

| | 2806 | |
|------------------------------|-----------------------------|-----------------------------|
| | Port Benchmark to Waterline | Stbd Benchmark to Waterline |
| Measure 1 | -90.4 | -94.4 |
| Measure 2 | -93.4 | -96.0 |
| Measure 3 | -92.6 | -93.2 |
| Avg (cm) | -92.13 | -94.53 |
| Avg (m) | -0.9213 | -0.9453 |
| Stdev | 0.01553 | 0.01405 |
| BM Z-value (m)* | 1.09615 | 1.01777 |
| BM to WL (m) | 0.175 | 0.072 |
| Individual measurement | 0.19215 | 0.07377 |
| | 0.16215 | 0.05777 |
| StDev for TPU xls (of 6 #'s) | 0.057619 | 0.08577 |

Measuring Party: Beduhn, Wozumi, Phunt, Allen

Waterline measurements should be negative and cm!

| | 2806 | |
|------------------------------|-----------------------------|-----------------------------|
| | Port Benchmark to Waterline | Stbd Benchmark to Waterline |
| Measure 1 | -96.2 | -95.2 |
| Measure 2 | -96.0 | -95.0 |
| Measure 3 | -94.2 | -94.8 |
| Avg (cm) | -95.47 | -95.00 |
| Avg (m) | -0.9547 | -0.9500 |
| Stdev | 0.01102 | 0.00200 |
| BM Z-value (m) | 1.09615 | 1.01777 |
| BM to WL (m) | 0.141483333 | 0.068 |
| Individual measurement | 0.13415 | 0.06577 |
| | 0.13615 | 0.06777 |
| StDev for TPU xls (of 6 #'s) | 0.040991 | 0.06977 |

Measuring Party:

Waterline measurements should be negative and cm!

| | 2806 | |
|------------------------------|-----------------------------|-----------------------------|
| | Port Benchmark to Waterline | Stbd Benchmark to Waterline |
| Measure 1 | -98.4 | -97.7 |
| Measure 2 | -97.5 | -97.8 |
| Measure 3 | -97.3 | -98.7 |
| Avg (cm) | -97.73 | -98.07 |
| Avg (m) | -0.9773 | -0.9807 |
| Stdev | 0.00586 | 0.00551 |
| BM Z-value (m) | 1.09615 | 1.01777 |
| BM to WL (m) | 0.119 | 0.037 |
| Individual measurement | 0.11215 | 0.04077 |
| | 0.12115 | 0.03977 |
| StDev for TPU xls (of 6 #'s) | 0.045044 | 0.03077 |

Fill in Yellow squares only!

Date: 3/9/2010
Fuel Level: Full
Draft Tube:

Port-to-Stbd Z-difference

| Theoretical | Actual | Error |
|-------------|---------|---------|
| 0.0784 | -0.0240 | -0.1024 |

RP to WL Average (m)

0.124 NGS Coordinate System (do not enter in CARIS directly)
(Add this value to VSSL_Offsets & Measurements_20XX.xls)

utilized in Offsets and Measurements and TPU spreadsheet

Date: 3/9/2010
Fuel Level: 3/4 Full
Draft Tube:

Port-to-Stbd Z-difference

| Theoretical | Actual | Error |
|-------------|--------|---------|
| 0.0784 | 0.0047 | -0.0737 |

RP to WL Average (m)

0.105 NGS Coordinate System (do not enter in CARIS directly)
(or add this value to VSSL_Offsets & Measurements_20XX)

utilized in Offsets and Measurements and TPU spreadsheet

Date: 4/1/2010
Fuel Level: 3/10 Full 35.2 Gal
Draft Tube:

Port-to-Stbd Z-difference

| Theoretical | Actual | Error |
|-------------|---------|---------|
| 0.0784 | -0.0033 | -0.0817 |

RP to WL Average (m)

0.078 NGS Coordinate System (do not enter into CARIS directly)
(or add this value to VSSL_Offsets & Measurements_20XX)

US DEPARTMENT OF COMMERCE
NATIONAL OCEANIC & ATMOSPHERIC ADMINISTRATION
NATIONAL OCEAN SERVICE
NATIONAL GEODETIC SURVEY
GEODETIC SERVICES DIVISION
INSTRUMENTATION & METHODOLOGIES BRANCH

**NOAA SURVEY VESSEL 2806
POS MV COMPONENTS SPATIAL RELATIONSHIP
SURVEY
FIELD REPORT**

Kendall L. Fancher
January, 2010



**NOAA SURVEY VESSEL 2806
POS MV COMPONENTS SPATIAL RELATIONSHIP SURVEY**

PURPOSE

The primary purpose of the survey was to precisely determine the spatial relationship between various hydrographic surveying sensors, launch bench marks and the components of a POS MV navigation system aboard the NOAA survey vessel 2806.

PROJECT DETAILS

This survey was conducted in Seattle, WA at the NOAA Western Center on the 26th of January, 2010. The weather was sunny then cloudy with temperatures in the 40s to 50s. For this survey, the vessel was on blocks, supported by boat jacks. The vessel was reported to have been leveled relative to the IMU.

INSTRUMENTATION

A Leica TDA5005 precision total station was used to make all measurements.

Technical Data:

| Standard Deviation | |
|----------------------|-------------|
| Horizontal angle | 0.5 seconds |
| Vertical angle | 0.5 seconds |
| Distance measurement | 1mm + 1ppm |

Leica precision prisms were used as sighting targets. Prisms were configured to have a zero mm offset.

PERSONNEL

Kendall Fancher NOAA/NOS/NGS/GSD/I&M BRANCH
(540) 373-1243
kendall.fancher@noaa.gov

Dennis Lokken NOAA/NOS/NGS/GSD/I&M BRANCH
(540) 373-1243
dennis.lokken@noaa.gov

**NOAA SURVEY VESSEL 2806
POS MV COMPONENTS SPATIAL RELATIONSHIP SURVEY**

DEFINITION OF THE REFERENCE FRAME

For this survey, data was collected in a 3-D right handed Cartesian coordinate system. The origin of this coordinate system is defined as the center of the IMU target. The Y (Northing) axis is parallel to the centerline of the launch and is positive towards the bow of the launch. The X (Easting) axis is perpendicular to the Y axis and is positive towards the starboard side of the launch. The Z (Elevation) axis is perpendicular to the XY plane and is positive towards the top of the launch. The coordinates of the points established this survey are reported in this coordinate system and are provided in Appendix A.

SURVEY METHODOLOGY

Four temporary control points, (1, 2, 3, and 4), were established around the vessel such that every point to be positioned on the launch could be observed from at least two separate locations.

Coordinates of 100.000N, 100.000E, and 100.000U were assumed for temporary control point 1. A distance and height difference were measured between control points 1 and 2. Temporary control point 2 was assumed to have an Easting of 100.000. The measured distance between these two points was used to determine the Northing for temporary control point 2. The height difference between the two points was used to determine the Up component for control point 2.

Control point 1 was occupied and control point 2 was observed to initialize the instrument. After initialization, control point 4 and all visible points to be observed on the launch were observed in both direct and reverse. The stability of the instrument setup was checked at conclusion of the data set collection by checking back to temporary control point 2.

Control point 2 was occupied and control point 1 was observed to initialize the instrument. After initialization, control point 3 and all visible points to be observed on the launch were observed in both direct and reverse. The stability of the instrument setup was checked at conclusion of the data set collection by checking back to temporary control point 1.

Control point 3 was occupied and control point 2 was observed to initialize the instrument. After initialization, control point 4 and all visible points to be observed on the launch were observed in both direct and reverse. The stability of the instrument setup was checked at conclusion of the data set collection by checking back to temporary control point 2.

NOAA SURVEY VESSEL 2806 POS MV COMPONENTS SPATIAL RELATIONSHIP SURVEY

Control point 4 was occupied and control point 3 was observed to initialize the instrument. After initialization, all visible points to be observed on the launch were observed in both direct and reverse. Control point 1 was also observed in order to evaluate the accuracy of the traverse. Inverse computations between the original and observed control point yielded a horizontal accuracy, or traverse closure of 0.000m and a vertical accuracy of 0.000m. The stability of the instrument setup was checked at conclusion of the data set collection by checking back to temporary control point 2.

Inverses were computed between the two positions determined for all points surveyed to evaluate their accuracy relative to the temporary control network. Inverse reports are included in appendix B.

The reference frame was rotated using CENTERLINE STERN BM (CLS) as the point of rotation. A zero degree azimuth was used during the rotation from CLS to CENTERLINE BOW BM (BMB). The reference frame was then translated to relocate the origin of the reference frame to the IMU. The resulting coordinates are reported in appendix A.

DISCUSSION

The positions given for the POS GPS antennas (Zephyr p/n 39105-00) are to the top center of the antenna. To correct the Z value provided in this report for each antenna to the electronic phase center, I recommend the following steps be taken;

- 1) Determine the physical height of the GPS antenna. This information is probably located on the antenna or with equipment documentation.
- 2) Investigate to find the electronic phase center offset of the antenna. This information is probably located on the antenna or with equipment documentation. This value may also be available at the NGS website for antenna modeling.
- 3) Subtract the total height of the antenna from the Z value for each antenna. This will give you a Z value for the antenna ARP (antenna reference point)
- 4) Then add to this value the electronic phase center offset value appropriate for the antenna model.



NOAA SURVEY VESSEL 2806 POS MV COMPONENTS SPATIAL RELATIONSHIP SURVEY

Two reference points (MBF and MBA) were positioned in order to facilitate future measurements to the Multi-Beam sensor by launch personnel. These reference points are punch marks set along the center of the keel, at the locations described in the image at right.



A point on the Multi-Beam transducer (MB) was measured directly this survey. The measured point was at the center of the bottom of the transducer. No mark was left to indicate the measured point.



The point positioned for the Inertial Motion Unit (IMU) this survey was the center of the target affixed to the top of the unit. Additionally, a reference mark (IMUR) was established on the plate the IMU is attached to at a point where two scribed lines intersect, forward of the IMU.

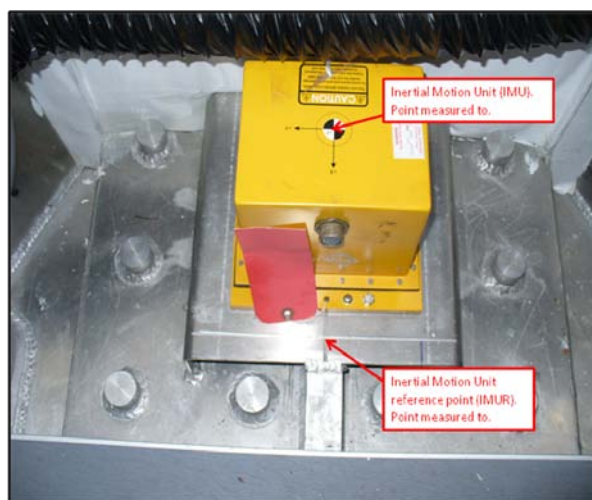

**NOAA SURVEY VESSEL 2806
POS MV COMPONENTS SPATIAL RELATIONSHIP SURVEY**

STATION LISTING

| | |
|-------|---|
| BMB- | CENTERLINE BOW BM The center of a cross mark inscribed into the top of a square metal flange, welded to the deck, along the centerline and near the bow of the launch. |
| CLS- | CENTERLINE STERN BM The center of a cross mark inscribed into the top of a square metal flange, welded to the deck, along the centerline and near the stern of the launch. |
| BMC- | CENTERLINE CAB BM The center of a cross mark inscribed into the top of a square metal flange, welded to the top of the cab, along the centerline of the launch. |
| BMP- | PORT SIDE BM The center of a cross mark inscribed into the top of a square metal flange, welded to the top of the deck, near the middle of and along the port side of the launch. |
| BMS- | STARBOARD SIDE BM The center of a cross mark inscribed into the top of a square metal flange, welded to the top of the deck, near the middle of and along the starboard side of the launch. |
| MBF- | KEEL BM A punch mark set along the bottom center of the keel, fore of the multi-beam transducer, 0.030 m from a point where the keel makes a 90 degree angle upwards. |
| MBA- | KEEL BM A punch mark set along the bottom center of the keel, aft of the multi-beam transducer, 0.030 m from a point where the keel makes a 90 degree angle upwards. |
| IMU- | IMU TARGET Center of a target affixed to the top of the IMU housing. |
| IMUR- | IMU REFERENCE BM The intersection of two scribed lines atop a metal support plate for the IMU and forward of the IMU. |
| GPSP- | PORT SIDE GPS ANTENNA REFERENCE POINT The top center of the port side GPS antenna for the POS system. |
| GPSS- | STARBOARD GPS ANTENNA REFERENCE POINT The top center of the starboard side GPS antenna for the POS system. |
| MB- | MULTI-BEAM REFERENCE POINT The physical bottom center of the Multi-Beam transducer. |

Appendix A

Coordinate Report Launch 2806

| <i>Pt Name</i> | <i>North(Y)</i> | <i>East(X)</i> | <i>UP(Z)</i> | <i>ID</i> |
|-------------------------------|-----------------|----------------|--------------|-----------|
| IMU Target | 0.00000 | 0.00000 | 0.00000 | IMU |
| IMU Reference BM | 0.13142 | -0.01122 | -0.16986 | IMUR |
| Centerline Stern BM | -4.08215 | 0.02583 | 0.62671 | CLS |
| Centerline Bow BM | 3.44035 | 0.02583 | 1.42590 | BMB |
| Portside GPS Ant. Ref. Point | -0.83249 | -0.63695 | 3.14938 | GPSP |
| Starboard GPS Ant. Ref. Point | -0.82526 | 0.81062 | 3.10821 | GPSS |
| Multi-Beam Ref.Point | 0.25447 | -0.01284 | -0.48083 | MB |
| Keel BM | 0.44302 | -0.02150 | -0.61052 | MBF |
| Keel BM | -0.22767 | -0.01641 | -0.53926 | MBA |
| Port Side BM | 0.08725 | -1.41542 | 1.09615 | BMP |
| Starboard Side BM | 0.09859 | 1.46945 | 1.01777 | BMS |
| Centerline Cab BM | -0.21255 | 0.06840 | 2.64944 | BMC |

Units = meters

Appendix B

Point to Point Inverse Launch 2806

| <i>Pt. 1</i> | <i>Pt. 2</i> | <i>Dist.</i> | <i>Northing</i> | <i>Easting</i> | <i>Elevation</i> | <i>ID</i> |
|--------------|--------------|--------------|-----------------|----------------|------------------|-----------|
| 24 | 42 | 0.001 | 0.000 | -0.001 | 0.00012 | SBF |
| 6 | 22 | 0.000 | 0.000 | 0.000 | 0.00025 | SBA |
| 7 | 23 | 0.001 | 0.001 | -0.001 | 0.00048 | SB |
| 33 | 35 | 0.004 | 0.003 | 0.001 | 0.00015 | IMUR |
| 36 | 32 | 0.004 | -0.002 | -0.004 | 0.00010 | IMU |
| 37 | 25 | 0.002 | 0.001 | 0.001 | 0.00013 | CLS |
| 12 | 26 | 0.002 | -0.001 | -0.002 | 0.00054 | BMS |
| 38 | 50 | 0.002 | -0.002 | 0.000 | 0.00010 | BMP |
| 52 | 20 | 0.006 | 0.006 | -0.003 | 0.00045 | BMB |
| 51 | 15 | 0.002 | 0.001 | 0.002 | 0.00011 | BMC |
| 13 | 27 | 0.003 | 0.003 | -0.001 | 0.00080 | GPSS |
| 28 | 14 | 0.000 | 0.000 | 0.000 | 0.00023 | GPSP |

Units = meters

FAIRWEATHER

Multibeam Echosounder Calibration

Launch 2806 200kHz

Vessel

| | | |
|-----------------------------------|----------------------|--|
| Reson 7125 200kHz | Launch 2806 | 11/30/2009 |
| MBES System | MBES System Location | Date of most recent EED/Factory Check |
| TBD | | CD0001529685 |
| Sonar Serial Number | | Processing Unit Serial Number |
| Plate mounted on hull | | 1/26/2010 |
| Sonar Mounting Configuration | | Date of current offset measurement/verification |
| DGPS Beacon 323, POSMV V4 | | 3/08/2010 |
| Description of Positioning System | | Date of most recent positioning system calibration |

Acquisition Log

| | | | |
|-------------|-----|------------|-------------------------|
| 3/9/2010 | 068 | | |
| Date | Dn | Local Area | Wx |
| | | | |
| Bottom Type | | | Approximate Water Depth |

Pfundt, Wozumi, Beduhn, Akken

Personnel on board

Comments

2010_068_2806.000

TrueHeave filename

| | | | |
|---------------------|-------------|--------------|------------|
| 1856 | 47 40 35.67 | 122 25 22.10 | 51.7 |
| SV Cast #1 filename | L Lat | Lon | Depth |
| | | | Ext. Depth |
| 2038 | 47/40/32.13 | 122/25/18.83 | 44.7 |
| SV Cast #2 filename | L Lat | Lon | Depth |
| | | | Ext. Depth |

Processing Log

3/10/2010 | | Beduhn
 Date Dn Personnel

Data converted --> HDCS_Data in CARIS

TrueHeave applied 2009_064_2808.000

SVP applied 2010_064_2808.000

Tide applied N395RA2009.tc predicted

Zone file _____

Lines merged

Data cleaned to remove gross fliers

Compute correctors in this order

1. Precise Timing

2. Pitch bias

3. Heading bias

4. Roll bias

Do not enter/apply correctors until all evaluations are complete and analyzed.

PATCH TEST RESULTS/CORRECTORS

| Evaluators | Latency (sec) | Pitch (deg) | Roll (deg) | Yaw (deg) |
|---------------------------|---------------|-------------|------------|-----------|
| AST Francksen | 0.00 | -1.57 | -0.24 | 0.30 |
| LT Welton | 0.00 | -1.50 | -0.25 | 0.38 |
| PS Wozumi | 0.00 | -1.56 | -0.23 | 0.43 |
| SST Beduhn | 0.00 | -1.47 | -0.25 | 0.38 |
| | | | | |
| | | | | |
| | | | | |
| | | | | |
| Averages | 0.00 | -1.53 | -0.24 | 0.37 |
| Standard Deviation | 0.00 | 0.05 | 0.01 | 0.05 |
| FINAL VALUES | 0.00 | -1.53 | -0.24 | 0.37 |

Final Values based on Averages

Resulting HVF File Name FA_2806_200kHz_rsn7125_256bms_2010

MRU Align StdDev gyro 0.05 Value from standard deviation of Heading offset values
 MRU Align StdDev Roll/Pitch 0.03 Value from averaged standard deviations of pitch and roll offset values

NARRATIVE

HVF Hydrographic Vessel File created or updated with current offsets

Name: CST/FOO

Date: 03/30/2010

FAIRWEATHER

Multibeam Echosounder Calibration

Launch 2806 400kHz

Vessel

CST Morgan, LT Welton, SST Beduhn, PS Wozumi

Calibrating Hydrographer(s)

| | | |
|-----------------------------------|----------------------|--|
| Reson 7125 400kHz | Launch 2806 | 11/30/2009 |
| MBES System | MBES System Location | Date of most recent EED/Factory Check |
| Sonar Serial Number | CD0001529685 | Processing Unit Serial Number |
| Plate mounted on hull | 1/26/2010 | Date of current offset measurement/verification |
| Sonar Mounting Configuration | | |
| DGPS Beacon 323, POSMV V4 | 3/08/2010 | Date of most recent positioning system calibration |
| Description of Positioning System | | |

Acquisition Log

| | | | |
|----------|-----|------------|----|
| 3/9/2010 | 068 | | |
| Date | Dn | Local Area | Wx |

| | |
|-------------|-------------------------|
| Bottom Type | Approximate Water Depth |
|-------------|-------------------------|

Pfundt, Wozumi, Beduhn, Allen

Personnel on board

all lines run at 6-6.5 knots unless otherwise

Comments

2010_068_2806.000

TrueHeave filename

| | | | |
|---------------------|-------------|--------------|-------|
| 1856 | 47 40 35.67 | 122 25 22.10 | 51.7 |
| SV Cast #1 filename | Lat | Lon | Depth |
| 2038 | 47/40/32.13 | 122/25/18.83 | 44.7 |
| SV Cast #2 filename | Lat | Lon | Depth |

view parallel to track, one line with induced roll (outerbeam) or same lines bounded slope (nadir)
 [same direction, different speed]

NAV TIME LATENCY

| SV Cast # | XTF Line Filename | Heading | Speed (kts) | Remarks |
|-----------|-------------------|---------|-------------|---------|
| 2 | 2015 | | | |
| 2 | 2017 | | | |
| | | | | |
| | | | | |
| | | | | |
| | | | | |
| | | | | |
| | | | | |

PITCH view parallel to track, same line (at nadir) [opposite direction, same speed]

| SV Cast # | XTF Line Filename | Heading | Speed (kts) | Remarks |
|-----------|-------------------|---------|-------------|---------------|
| 2 | 2121 | 120 | | 103 |
| 2 | 2122 | 327 | | 103 |
| 2 | 2124 | 139 | | 103 bad line? |
| 2 | 2125 | 325 | | 103 |
| | | | | |
| | | | | |
| | | | | |
| | | | | |
| | | | | |

HEADING/YAW view parallel to track, offset lines (outerbeams) [opposite direction, same speed]

| SV Cast # | XTF Line Filename | Heading | Speed (kts) | Remarks |
|-----------|-------------------|---------|-------------|-------------------|
| 2 | 2126 | 128 | | 104 questionable? |
| 2 | 2127 | 320 | | 101 |
| 2 | 2128 | 135 | | 101 |
| 2 | 2129 | 316 | | 104 |
| 2 | 2131 | 132 | | 104 |
| | | | | |
| | | | | |
| | | | | |
| | | | | |

ROLL view across track, same line [opposite direction, same speed]

| SV Cast # | XTF Line Filename | Heading | Speed (kts) | Remarks |
|-----------|-------------------|---------|-------------|----------------------------|
| 2 | 2134 | 060 | | slow speed due to sailboat |
| 2 | 2136 | 232 | | |
| 2 | 2140 | 064 | | |
| 2 | 2143 | 230 | | |
| | | | | |
| | | | | |
| | | | | |
| | | | | |

Processing Log

3/10/2010 | | Beduhn
 Date Dn Personnel

Data converted --> HDCS_Data in CARIS

TrueHeave applied 2009_064_2808.000

SVP applied 2010_064_2808.000

Tide applied N395RA2009.tc predicted

Zone file _____

Lines merged

Data cleaned to remove gross fliers

Compute correctors in this order

1. Precise Timing 2. Pitch bias 3. Heading bias 4. Roll bias

Do not enter/apply correctors until all evaluations are complete and analyzed.

PATCH TEST RESULTS/CORRECTORS

| Evaluators | Latency (sec) | Pitch (deg) | Roll (deg) | Yaw (deg) |
|---------------------------|---------------|-------------|------------|-----------|
| CST Morgan | 0.00 | -1.80 | -0.09 | 0.60 |
| LT Welton | 0.00 | -1.14 | -0.10 | -0.25 |
| SST Beduhn | 0.00 | -1.98 | -0.08 | 0.62 |
| | 0.00 | -1.79 | -0.09 | 0.57 |
| | | | | |
| | | | | |
| | | | | |
| | | | | |
| Averages | 0.00 | -1.86 | -0.09 | 0.60 |
| Standard Deviation | 0.00 | 0.11 | 0.01 | 0.03 |
| FINAL VALUES | 0.00 | -1.86 | -0.09 | 0.60 |

Final Values based on averages, with outliers removed

Resulting HVF File Name FA_2806_400kHz_Rsn7125_512bms_2010

MRU Align StdDev gyro 0.03 Value from standard deviation of Heading offset values*
 MRU Align StdDev Roll/Pitch 0.06 Value from averaged standard deviations of pitch and roll offset values
 *Std Dev calculations did not include outliers.

NARRATIVE

HVF Hydrographic Vessel File created or updated with current offsets

Name: CST/FOO

Date: 03/30/2010

***Fairweather* Launch 2806 Dynamic Draft Measurement Lake Washington, 08 March 2010**

LTjg Caryn Arnold, HSTP West Coast Field Support Liaison

On Monday, 08 March 2010 (DN 067), *Fairweather* Launch 2806 conducted a dynamic draft measurement (DDM) on Lake Washington using post processed kinematic GPS data. The vessel sat at rest for approximately 5 minutes, then ran in the South direction at approximate speeds of 4, 6, 8 and 10 knots, holding each speed for about 4 minutes. The vessel then turned around and ran in the North direction at approximate speeds of 10, 8, 6 and 4 knots, again holding each speed for about 4 minutes and resting for approximately 5 minutes at the end. The POS/MV recorded a POSpac file the entire time from beginning rest to finish rest.

The POSpac file was processed with POSpac MMS Software using the GNSS-Inertial Processing Single Base Station Mode. The single CORS station SEAI (1 Hz) was chosen as the base station. The Lever Arm Standard Deviation was set to <3cm and then the GNSS-Inertial Processor in the Forward, Backward and Combine mode was Run.

The file was then exported out from the POSpac MMS software with an output rate of 1 sec and run through the Python Script written by LTjg Glen Rice, which includes the fourth order polynomial curve. The following graphs were generated.

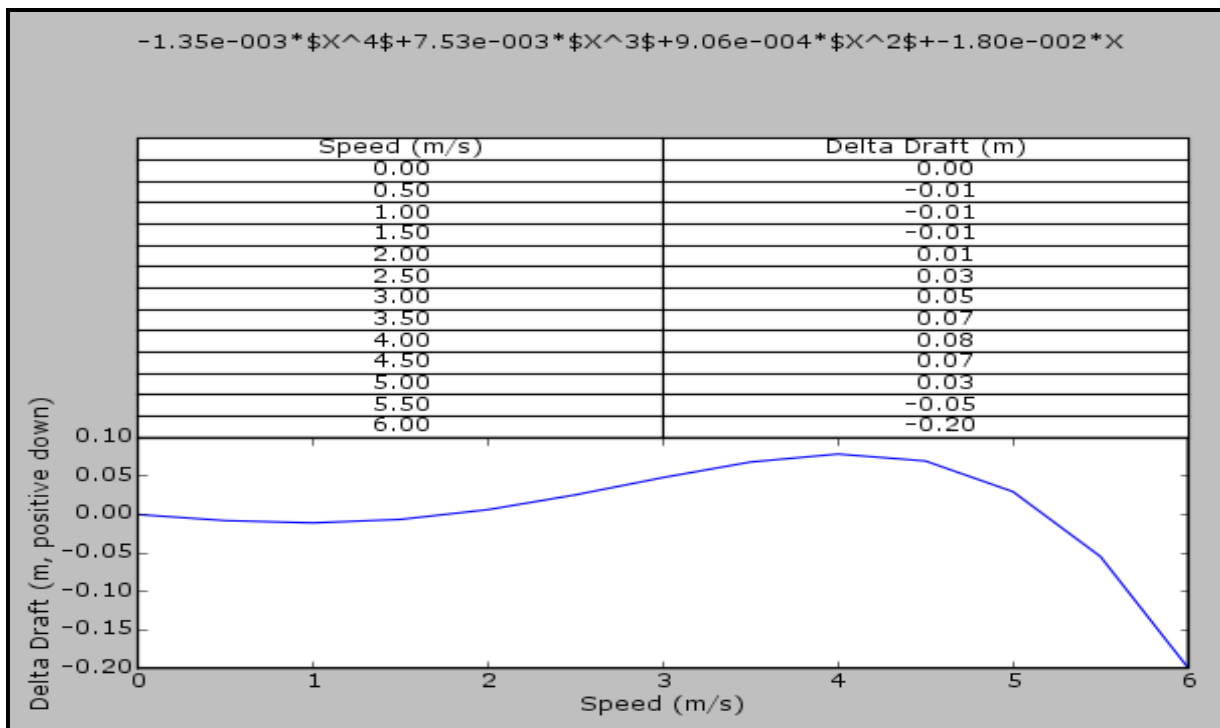

Figure 1. *Fairweather* Launch 2806 Inverted Dynamic Draft Curve & Computed Dynamic Draft Table for Caris

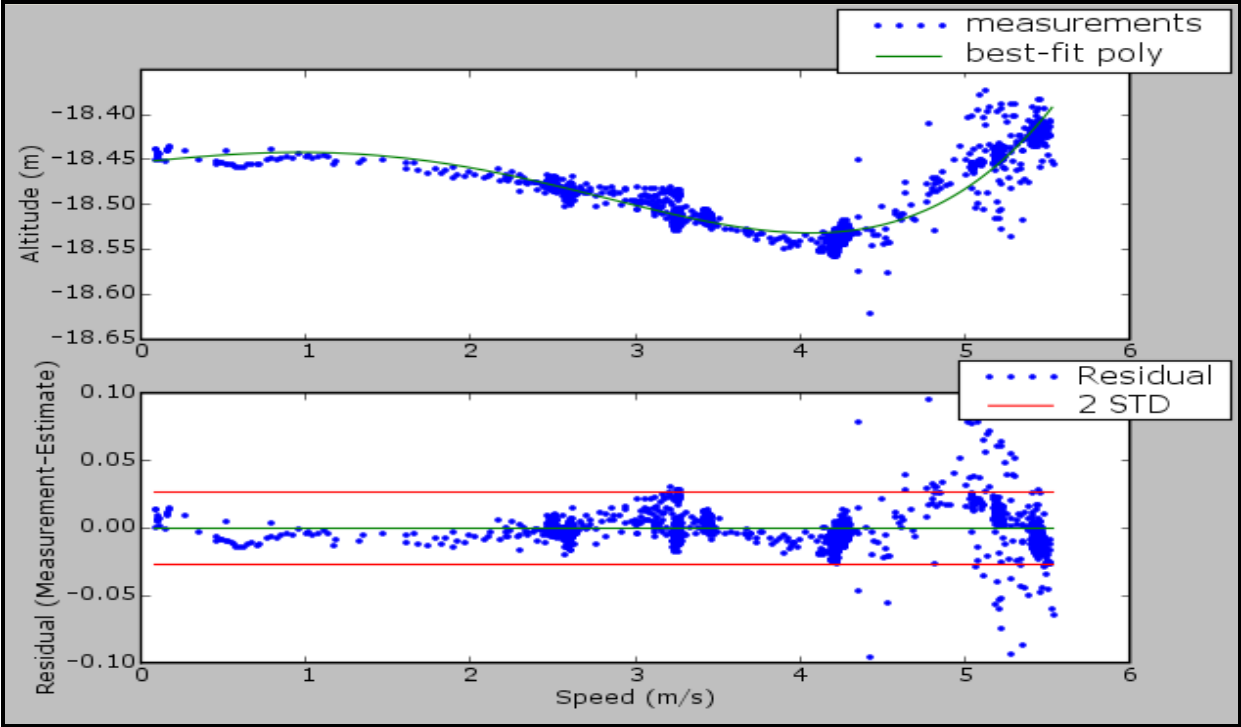

Figure 2. Fairweather Launch 2806 Dynamic Draft Curve with Data Points

2807 Offsets and Measurements - Summary

| Measurement aka | IMU to RP* | IMU to 7125 (Receiver) SWATH1 x,y,z & MRU to Trans | Port Ant to 7125 Nav to Trans x,y,z | RP* to Waterline | Port Ant to Stbd Ant | IMU to Port Ant | IMU to Heave |
|-----------------|------------|---|--|------------------|-----------------------|-----------------|--------------|
| Coord. Sys. | Caris | Caris | Caris | Caris | | Caris | Pos/Mv |
| x | 0.000 | 0.019 | 0.804 | n/a | Scaler Distance 1.440 | -0.786 | -0.812 |
| y | 0.000 | 0.244 | 1.056 | n/a | | -0.812 | -0.786 |
| z | 0.000 | 0.481 | 3.628 | -0.130 | | -3.147 | -3.147 |
| | | | | | | 0.000 | 0.000 |
| | | | | | | 0.000 | 0.000 |
| | | | | | | 0.000 | 0.000 |

*IMU is Reference Point

Vessel Offsets for 2808 7125 are derived from the NGS Survey, January 2010, Trimble Equipment Specs, & 2010 Measured Values.

Calculations

| Coord. Sys./ Source | IMU to 7125 | Port Ant to 7125 | RP to Waterline | Port Ant to Stbd Ant | IMU to Port Ant | IMU to Heave |
|---------------------|--|--|---|---|---|--|
| NGS | IMU (m) x 0.00000 y 0.00000 z 0.00000 | IMU to x -0.78576 Port Ant (m) y -0.81181 (calculated) z 3.14689 | RP to Waterline (m) (waterline z 0.130 worksheet) | IMU to x -0.78576 Port Ant (m) y -0.81181 (calculated) z 3.14689 | IMU (m) x 0.00000 y 0.00000 z 0.00000 | IMU (m) x 0.00000 y 0.00000 z 0.00000 |
| | MBES RP Rcvr - Phase Center (m) x 0.01867 y 0.24441 z -0.48063 | IMU to x 0.01867 Phase Ctr y 0.24441 (calculated) z -0.48063 | | IMU (m) x, y, z 0.00000 Top of Stbd Ant (m) x 0.65423 y -0.81691 z 3.16283 | Top of Port Ant (m) x -0.78576 y -0.81181 z 3.13559 | Heave Pt (m) x 0.00000 (by design) y 0.00000 z 0.00000 |
| | | | | Base to top of Stbd Ant (eqp spec) (m) z 0.073 | Base to top of Port Ant (measured) (m) z 0.073 | |
| | | | | Bottom of Stbd Ant (calculated) (m) z 3.08983 | Bottom of Port Ant (calculated) (m) z 3.06259 | |
| | | | | Base to Phase Cntr of Stbd Ant (eqp spc) (m) z 0.0843 | Base to Phase Cntr of Port Ant (eqp spc) (m) z 0.0843 | |
| Coord. Sys. NGS | IMU to x 0.01867 Phase Ctr y 0.24441 z -0.48063 | Port Ant to 7125 x 0.80443 y 1.05622 z -3.62752 | RP to Waterline x n/a y n/a z 0.130 | Port Ant to Stbd Ant Scalar Distance 1.4403 | IMU to Port Ant x -0.78576 y -0.81181 z 3.14689 | IMU to Heave x 0.00000 y 0.00000 z 0.00000 |
| | Coord. Sys. CARIS x 0.01867 y 0.24441 z 0.48063 | Coord. Sys. CARIS x 0.80443 y 1.05622 z 3.62752 | Coord. Sys. CARIS x n/a y n/a z -0.130 | | Coord. Sys. Pos/Mv x -0.81181 y -0.78576 z -3.14689 | Coord. Sys. Pos/Mv x 0.00000 y 0.00000 z 0.00000 |

Description of Offsets for Launch 2807

All Values Shown are in CARIS Coordinates

The Ship Reference Frame (SRF) for Launch 2807 was based from IMU Reference Point as the 0,0,0 point. Physical locations were measured with x,y,z offsets from this point. These locations were used to calculate offsets of items with respect to each other, as described for each offset.

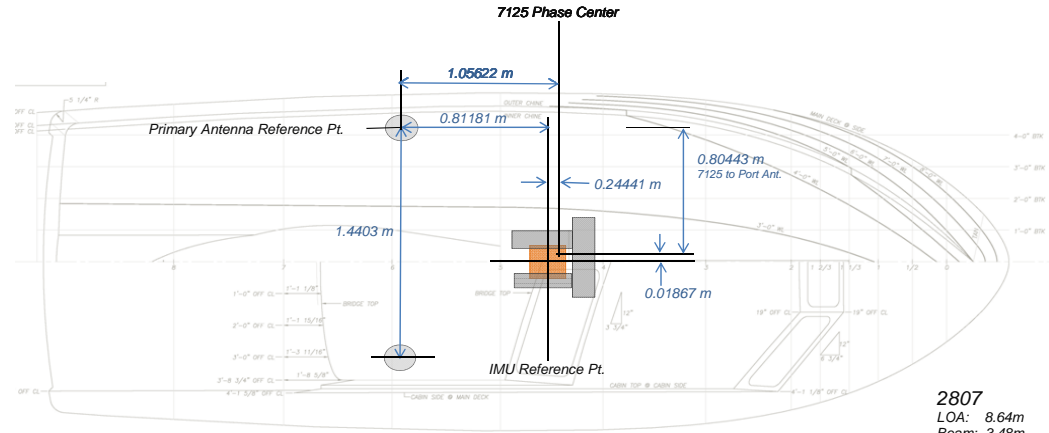
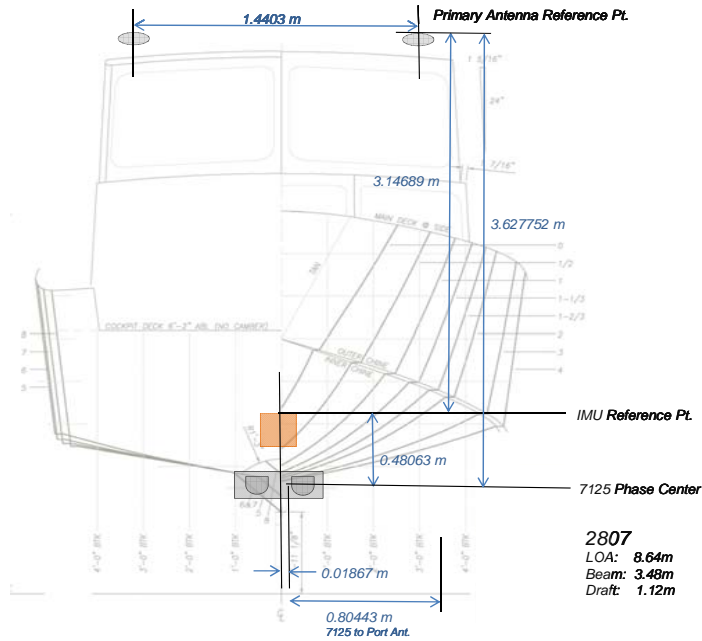

2807
LOA: 8.64m
Beam: 3.48m
Draft: 1.12m

| IMU to 7125 | | |
|-------------|-------|-------|
| x | y | z |
| 0.019 | 0.244 | 0.481 |

The physical positions of the IMU and the receiver phase center of the 7125 were measured during the NGS survey. These physical measurements were taken while the launch was secured on the pier and thought to be as level as possible. The measured values for the IMU and MB were taken directly for the report. The difference is the offset from the IMU to the phase center of the 7125 which was then transposed from the NGS to the CARIS coordinate system.

| Port Ant to 7125 | | |
|------------------|-------|-------|
| x | y | z |
| 0.804 | 1.056 | 3.628 |

The values were calculated by subtracting the of the Port Antenna to the IMU x, y, z values from the respective values of the IMU to the 7125. The calculated values were then transposed from the NGS to the CARIS coordinate system.

| RP to Waterline | | |
|-----------------|-----|--------|
| x | y | z |
| N/A | N/A | -0.130 |

The average vertical distance from Port Benchmark to waterline and the Starboard Benchmark to the waterline were measured by FAIRWEATHER personnel using a steel tape and bubble level. These values were combined with the Z value of the Benchmarks to the RP/IMU to get an average for the waterline to RP. The Waterline Measurement value is in NGS coordinates initially and is converted to CARIS coordinates.

| Port Ant to Stbd Ant | |
|----------------------|--|
| Scalar Distance | |
| 1.440 | |

The location of the phase center of the port and starboard POS/MV antennas were surveyed by NGS. The z-values were adjusted to the phase center. Then the scalar distance between the phase centers was

| IMU to Port Antenna | | |
|---------------------|--------|--------|
| x | y | z |
| -0.786 | -0.812 | -3.147 |

The location of the IMU and the location of the top of port antenna were surveyed by NGS. The z-value of the antenna was calculated by subtracting the height of the antenna and then adding the value from the base of the antenna to the phase center of the antenna. The calculation results were then transposed from the NGS to the CARIS coordinate system.

| IMU to Heave | | |
|--------------|-------|-------|
| x | y | z |
| 0.000 | 0.000 | 0.000 |

The Heave Point is assumed to coincide with the IMU location.

Waterline Measurements

Measuring Party: Beduhn, Wilson, Marcum, Jaskoski

2807

Waterline measurements should be negative and cm!

| | 2807 | |
|------------------------------|-----------------------------|-----------------------------|
| | Port Benchmark to Waterline | Stbd Benchmark to Waterline |
| Measure 1 | -92.2 | -93.2 |
| Measure 2 | -93.1 | -92.9 |
| Measure 3 | -93.2 | -94.0 |
| Avg (cm) | -92.84 | -93.36 |
| Avg (m) | -0.9284 | -0.9336 |
| Stdev | 0.00529 | 0.00577 |
| BM Z-value (m)* | 1.03292 | 1.08830 |
| BM to WL (m) | 0.105 | 0.155 |
| Individual measurement | 0.11062 | 0.15630 |
| StDev for TPU xls (of 6 #'s) | 0.10212 | 0.15950 |
| | 0.10092 | 0.14830 |

0.027909

Fill in Yellow squares only!

Date: 2/4/2010 63

Fuel Level: 2/3 full

Draft Tube:

Port-to-Stbd Z-difference

| Theoretical | Actual | Error |
|-------------|---------|--------|
| -0.0554 | -0.0052 | 0.0501 |

RP to WL Average (m)

0.130

NGS Coordinate System (do not enter into CARIS directly)
(Add this value to VSSL_Offsets & Measurements_20XX.xls)

utilized in Offsets and Measurements and TPU spreadsheet

US DEPARTMENT OF COMMERCE
NATIONAL OCEANIC & ATMOSPHERIC ADMINISTRATION
NATIONAL OCEAN SERVICE
NATIONAL GEODETIC SURVEY
GEODETIC SERVICES DIVISION
INSTRUMENTATION & METHODOLOGIES BRANCH

**NOAA SURVEY VESSEL 2807
POS MV COMPONENTS SPATIAL RELATIONSHIP
SURVEY
FIELD REPORT**

Kendall L. Fancher
January, 2010



**NOAA SURVEY VESSEL 2807
POS MV COMPONENTS SPATIAL RELATIONSHIP SURVEY**

PURPOSE

The primary purpose of the survey was to precisely determine the spatial relationship between various hydrographic surveying sensors, launch bench marks and the components of a POS MV navigation system aboard the NOAA survey vessel 2807.

PROJECT DETAILS

This survey was conducted in Seattle, WA at the NOAA Western Center on the 27th of January, 2010. The weather was foggy early then sunny with temperatures in the 40s to 50s. For this survey, the vessel was on blocks, supported by boat jacks. The vessel was reported to have been leveled relative to the IMU.

INSTRUMENTATION

A Leica TDA5005 precision total station was used to make all measurements.

Technical Data:

| Standard Deviation | |
|----------------------|-------------|
| Horizontal angle | 0.5 seconds |
| Vertical angle | 0.5 seconds |
| Distance measurement | 1mm + 1ppm |

Leica precision prisms were used as sighting targets. Prisms were configured to have a zero mm offset.

PERSONNEL

Kendall Fancher NOAA/NOS/NGS/GSD/I&M BRANCH
(540) 373-1243
kendall.fancher@noaa.gov

Dennis Lokken NOAA/NOS/NGS/GSD/I&M BRANCH
(540) 373-1243
dennis.lokken@noaa.gov

**NOAA SURVEY VESSEL 2807
POS MV COMPONENTS SPATIAL RELATIONSHIP SURVEY**

DEFINITION OF THE REFERENCE FRAME

For this survey, data was collected in a 3-D right handed Cartesian coordinate system. The origin of this coordinate system is defined as the center of the IMU target. The Y (Northing) axis is parallel to the centerline of the launch and is positive towards the bow of the launch. The X (Easting) axis is perpendicular to the Y axis and is positive towards the starboard side of the launch. The Z (Elevation) axis is perpendicular to the XY plane and is positive towards the top of the launch. The coordinates of the points established this survey are reported in this coordinate system and are provided in Appendix A.

SURVEY METHODOLOGY

Four temporary control points, (1, 2, 3, and 4), were established around the vessel such that every point to be positioned on the launch could be observed from at least two separate locations.

Coordinates of 100.000N, 100.000E, and 100.000U were assumed for temporary control point 1. A distance and height difference were measured between control points 1 and 2. Temporary control point 2 was assumed to have an Easting of 100.000. The measured distance between these two points was used to determine the Northing for temporary control point 2. The height difference between the two points was used to determine the Up component for control point 2.

Control point 1 was occupied and control point 2 was observed to initialize the instrument. After initialization, control point 4 and all visible points to be observed on the launch were observed in both direct and reverse. The stability of the instrument setup was checked at conclusion of the data set collection by checking back to temporary control point 2.

Control point 2 was occupied and control point 1 was observed to initialize the instrument. After initialization, control point 3 and all visible points to be observed on the launch were observed in both direct and reverse. The stability of the instrument setup was checked at conclusion of the data set collection by checking back to temporary control point 1.

Control point 3 was occupied and control point 2 was observed to initialize the instrument. After initialization, control point 4 and all visible points to be observed on the launch were observed in both direct and reverse. The stability of the instrument setup was checked at conclusion of the data set collection by checking back to temporary control point 2.

NOAA SURVEY VESSEL 2807 POS MV COMPONENTS SPATIAL RELATIONSHIP SURVEY

Control point 4 was occupied and control point 3 was observed to initialize the instrument. After initialization, all visible points to be observed on the launch were observed in both direct and reverse. Control point 1 was also observed in order to evaluate the accuracy of the traverse. Inverse computations between the original and observed control point yielded a horizontal accuracy, or traverse closure of 0.001 m and a vertical accuracy of 0.000 m. The stability of the instrument setup was checked at conclusion of the data set collection by checking back to temporary control point 2.

Inverses were computed between the two positions determined for all points surveyed to evaluate their accuracy relative to the temporary control network. Inverse reports are included in appendix B.

The reference frame was rotated using CENTERLINE STERN BM (CLS) as the point of rotation. A zero degree azimuth was used during the rotation from CLS to CENTERLINE BOW BM (BMB). The reference frame was then translated to relocate the origin of the reference frame to the IMU. The resulting coordinates are reported in appendix A.

DISCUSSION

The positions given for the POS GPS antennas (Zephyr Model II p/n 57970-00) are to the top center of the antenna. To correct the Z value provided in this report for each antenna to the electronic phase center, I recommend the following steps be taken;

- 1) Determine the physical height of the GPS antenna. This information is probably located on the antenna or with equipment documentation.
- 2) Investigate to find the electronic phase center offset of the antenna. This information is probably located on the antenna or with equipment documentation. This value may also be available at the NGS website for antenna modeling.
- 3) Subtract the total height of the antenna from the Z value for each antenna. This will give you a Z value for the antenna ARP (antenna reference point)
- 4) Then add to this value the electronic phase center offset value appropriate for the antenna model.



NOAA SURVEY VESSEL 2807 POS MV COMPONENTS SPATIAL RELATIONSHIP SURVEY

Two reference points (MBF and MBA) were positioned in order to facilitate future measurements to the Multi-Beam sensor by launch personnel. These reference points are punch marks set along the center of the keel, at the locations described in the image at right.



A point on the Multi-Beam transducer (MB) was measured directly this survey. The measured point was at the center of the bottom of the transducer. No mark was left to indicate the measured point.

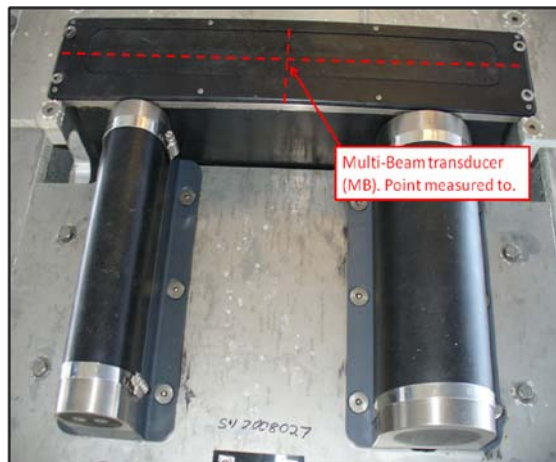

The point positioned for the Inertial Motion Unit (IMU) this survey was the center of the target affixed to the top of the unit. Additionally, a reference mark (IMUR) was established on the plate the IMU is attached to at a point where two scribed lines intersect, forward of the IMU.

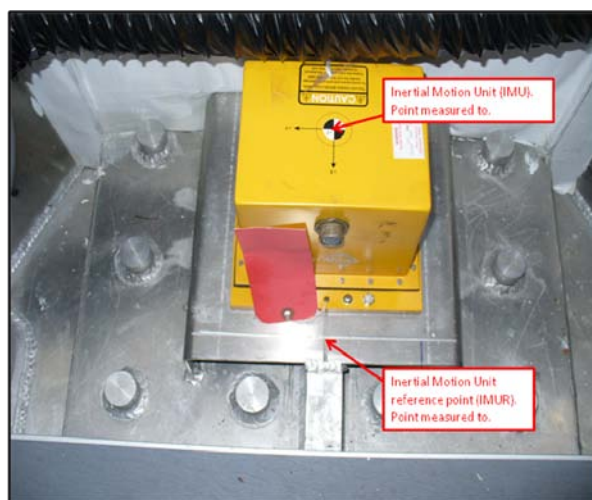

NOAA SURVEY VESSEL 2807
POS MV COMPONENTS SPATIAL RELATIONSHIP SURVEY

STATION LISTING

| | |
|-------|---|
| BMB- | CENTERLINE BOW BM The center of a cross mark inscribed into the top of a square metal flange, welded to the deck, along the centerline and near the bow of the launch. |
| CLS- | CENTERLINE STERN BM The center of a cross mark inscribed into the top of a square metal flange, welded to the deck, along the centerline and near the stern of the launch. |
| BMC- | CENTERLINE CAB BM The center of a cross mark inscribed into the top of a square metal flange, welded to the top of the cab, along the centerline of the launch. |
| BMP- | PORT SIDE BM The center of a cross mark inscribed into the top of a square metal flange, welded to the top of the deck, near the middle of and along the port side of the launch. |
| BMS- | STARBOARD SIDE BM The center of a cross mark inscribed into the top of a square metal flange, welded to the top of the deck, near the middle of and along the starboard side of the launch. |
| MBF- | KEEL BM A punch mark set along the bottom center of the keel, fore of the multi-beam transducer, 0.030 m from a point where the keel makes a 90 degree angle upwards. |
| MBA- | KEEL BM A punch mark set along the bottom center of the keel, aft of the multi-beam transducer, 0.030 m from a point where the keel makes a 90 degree angle upwards. |
| IMU- | IMU TARGET Center of a target affixed to the top of the IMU housing. |
| IMUR- | IMU REFERENCE BM The intersection of two scribed lines atop a metal support plate for the IMU and forward of the IMU. |
| GPSP- | PORT SIDE GPS ANTENNA REFERENCE POINT The top center of the port side GPS antenna for the POS system. |
| GPSS- | STARBOARD GPS ANTENNA REFERENCE POINT The top center of the starboard side GPS antenna for the POS system. |
| MB- | MULTI-BEAM REFERENCE POINT The physical bottom center of the Multi-Beam transducer. |

Appendix A

Coordinate Report Launch 2807

| <i>Pt Name</i> | <i>North(Y)</i> | <i>East(X)</i> | <i>UP(Z)</i> | <i>ID</i> |
|-------------------------------|-----------------|----------------|--------------|-----------|
| IMU Target | 0.00000 | 0.00000 | 0.00000 | IMU |
| IMU Reference BM | 0.13111 | 0.00714 | -0.16724 | IMUR |
| Centerline Stern BM | -4.06155 | -0.02156 | 0.64902 | CLS |
| Centerline Bow BM | 3.44775 | -0.02156 | 1.41160 | BMB |
| Portside GPS Ant. Ref. Point | -0.81181 | -0.78576 | 3.13559 | GPSP |
| Starboard GPS Ant. Ref. Point | -0.81691 | 0.65423 | 3.16283 | GPSS |
| Multi-Beam Ref.Point | 0.24441 | 0.01867 | -0.48063 | MB |
| Keel BM | 0.43114 | 0.01129 | -0.61049 | MBF |
| Keel BM | -0.23560 | 0.00988 | -0.53203 | MBA |
| Port Side BM | 0.09979 | -1.46918 | 1.03292 | BMP |
| Starboard Side BM | 0.08626 | 1.42671 | 1.08830 | BMS |
| Centerline Cab BM | -0.21841 | -0.05358 | 2.65245 | BMC |

Units = meters

Appendix B

Point to Point Inverse Launch 2807

| <i>Pt. 1</i> | <i>Pt. 2</i> | <i>Dist.</i> | <i>Northing</i> | <i>Easting</i> | <i>Elevation</i> | <i>ID</i> |
|--------------|--------------|--------------|-----------------|----------------|------------------|-----------|
| 18 | 37 | 0.002 | -0.002 | 0.000 | 0.00024 | MBF |
| 35 | 39 | 0.001 | -0.001 | -0.001 | 0.00027 | MBA |
| 19 | 36 | 0.004 | 0.001 | 0.004 | 0.00043 | MB |
| 29 | 27 | 0.006 | 0.001 | 0.006 | 0.00023 | IMUR |
| 26 | 30 | 0.006 | 0.005 | 0.004 | 0.00012 | IMU |
| 20 | 31 | 0.001 | -0.001 | -0.001 | 0.00038 | CLS |
| 32 | 45 | 0.000 | 0.000 | 0.000 | 0.00005 | BMP |
| 21 | 9 | 0.000 | 0.000 | 0.000 | 0.00057 | BMS |
| 49 | 16 | 0.007 | 0.007 | 0.000 | 0.00076 | BMB |
| 12 | 46 | 0.001 | -0.001 | 0.000 | 0.00044 | BMC |
| 11 | 47 | 0.003 | -0.002 | 0.001 | 0.00094 | GPSP |
| 10 | 48 | 0.002 | -0.002 | 0.001 | 0.00068 | GPSS |

Units = meters

FAIRWEATHER

Multibeam Echosounder Calibration

Launch 2807 200kHz

Vessel

4/21/2010 | 111 | Ketchikan, AK
Date Dn Local Area

Wozumi, Welton, Froelich
Calibrating Hydrographer(s)

7125 200kHz ED | 2807 | 01/01/2010
MBES System MBES System Location Date of most recent EED/Factory Check

TBD | CD0001527818
Sonar Serial Number Processing Unit Serial Number

Plate mounted on hull | 1/27/2010
Sonar Mounting Configuration Date of current offset measurement/verification

DGPS Beacon 323, POSMV V4 | 3/3/2010
Description of Positioning System Date of most recent positioning system calibration

Acquisition Log

4/21/2010 | 111 | Tongass NARROWS | ovc,
Date Dn Local Area Wx

Bottom Type | Approximate Water Depth

Nardi, Wozumi, Forney
Personnel on board

DGPS- 323, ED
Comments

2010_111_2807.000
TrueHeave filename

2010_111_193713.HEX | 55/20/00.25N | 131/37/57.50W | 46.7 |
SV Cast #1 filename L Lat Lon Depth Ext. Depth

SV Cast #2 filename | | | | |
L Lat Lon Depth Ext. Depth

SV Cast #3 filename | | | | |
L Lat Lon Depth Ext. Depth

Processing Log

4/22/2010 | 112 | Wozumi
 Date Dn Personnel

Data converted --> HDCS_Data in CARIS

TrueHeave applied 2010_111_2807.000

SVP applied 2010_111_193713

Tide applied

Zone file

Lines merged

Data cleaned to remove gross fliers

Compute correctors in this order

1. Precise Timing

2. Pitch bias

3. Heading bias

4. Roll bias

Do not enter/apply correctors until all evaluations are complete and analyzed.

PATCH TEST RESULTS/CORRECTORS

| Evaluators | Latency (sec) | Pitch (deg) | Roll (deg) | Yaw (deg) |
|---------------------------|---------------|-------------|------------|-----------|
| Wozumi | | -1.60 | 0.10 | 0.20 |
| Hypack (GF) | 0.00 | -2.20 | -0.30 | 4.50 |
| Welton | 0.00 | -1.10 | 0.10 | 0.45 |
| Froelich | | -1.40 | 0.09 | 0.51 |
| | | | | |
| | | | | |
| | | | | |
| | | | | |
| Averages | 0.00 | -1.58 | 0.10 | 1.42 |
| Standard Deviation | 0.00 | 0.25 | 0.01 | 0.16 |
| FINAL VALUES | 0.00 | -1.37 | 0.10 | 0.39 |

Final Values based on Wozumi, Welton, Froelich

Resulting HVF File Name FA_2807_200kHz_Rsn7125_256bms_2010.hvf

MRU Align StdDev gyro 0.16 Value from standard deviation of Heading offset values
 MRU Align StdDev Roll/Pitch 0.13 Value from averaged standard deviations of pitch and roll offset values

NARRATIVE

SBET was applied to data
 Added to hvf under Dn 091

HVF Hydrographic Vessel File created or updated with current offsets

Name: FA_2807_200kHz_Rsn7125_256bms_2010.hvf

Date: 5/21/2010

FAIRWEATHER

Multibeam Echosounder Calibration

Launch 2807 400kHz

Vessel

| | | |
|-----------|-----|----------------|
| 4/21/2010 | 111 | Tongass Narrow |
| Date | Dn | Local Area |

| |
|-----------------------------|
| Wozumi, Welton, Froelich |
| Calibrating Hydrographer(s) |

| | | |
|--------------|----------------------|---------------------------------------|
| Reson 7125sv | 2807 | 01/01/2010 |
| MBES System | MBES System Location | Date of most recent EED/Factory Check |

| | |
|---------------------|-------------------------------|
| TBD | CD0001527818 |
| Sonar Serial Number | Processing Unit Serial Number |

| | |
|------------------------------|---|
| Plate mounted on hull | 1/27/2010 |
| Sonar Mounting Configuration | Date of current offset measurement/verification |

| | |
|-----------------------------------|--|
| DGPS Beacon 323, POSMV V4 | 3/3/2010 |
| Description of Positioning System | Date of most recent positioning system calibration |

Acquisition Log

| | | | |
|-----------|-----|-----------------|------------------|
| 4/21/2010 | 111 | Tongass Narrows | Cloudy and rainy |
| Date | Dn | Local Area | Wx |

| | | | |
|-------------|-------------------------|--|--|
| | | | |
| Bottom Type | Approximate Water Depth | | |

| |
|-----------------------|
| Nardi, Wozumi, Forney |
| Personnel on board |

Comments

| |
|--------------------|
| 2010_111_2807.000 |
| TrueHeave filename |

| | | | | |
|---------------------|--------------|---------------|-------|------------|
| 2010_111_193713.HEX | 55/20/00.25N | 131/37/57.50W | 46.7 | |
| SV Cast #1 filename | U Lat | Lon | Depth | Ext. Depth |

| | | | | |
|---------------------|-------|-----|-------|------------|
| | | | | |
| SV Cast #2 filename | U Lat | Lon | Depth | Ext. Depth |

| | | | | |
|---------------------|-------|-----|-------|------------|
| | | | | |
| SV Cast #3 filename | U Lat | Lon | Depth | Ext. Depth |

Processing Log

4/22/2010 | 112 | Wozumi
 Date Dn Personnel

Data converted --> HDCS_Data in CARIS

TrueHeave applied

2010_111_2807.000

SVP applied 2010_111_193713

Tide applied

Zone file

Lines merged

Data cleaned to remove gross fliers

Compute correctors in this order

1. Precise Timing 2. Pitch bias 3. Heading bias 4. Roll bias

Do not enter/apply correctors until all evaluations are complete and analyzed.

PATCH TEST RESULTS/CORRECTORS

| Evaluators | Latency (sec) | Pitch (deg) | Roll (deg) | Yaw (deg) |
|---------------------------|---------------|-------------|------------|-----------|
| Wozumi | | -1.23 | 0.13 | 0.23 |
| Hypack (GF) | 0.00 | -1.60 | -0.30 | 3.60 |
| Welton | 0.00 | -1.10 | 0.10 | 0.39 |
| Froelich | 0.00 | -1.20 | 0.10 | 0.50 |
| Jaskoski | 0.00 | -1.15 | 0.11 | 0.60 |
| | | | | |
| | | | | |
| | | | | |
| Averages | 0.00 | -1.26 | 0.03 | 1.06 |
| Standard Deviation | 0.00 | 0.06 | 0.01 | 0.16 |
| FINAL VALUES | 0.00 | -1.17 | 0.11 | 0.43 |

Final Values based on Wozumi, Welton, Froelich, and Jaskoski averages

Resulting HVF File Name 2807_400kHz_MBES_Cal_2010.xls

MRU Align StdDev gyro 0.16 Value from standard deviation of Heading offset values
 MRU Align StdDev Roll/Pitch 0.04 Value from averaged standard deviations of pitch and roll offset values

NARRATIVE

SBET was applied to data

HVF Hydrographic Vessel File created or updated with current offsets

Name: Briana Welton

Date: 5/21/10

***Fairweather* Launch 2807 Dynamic Draft Measurement Custom House Cove, AK, 23 May 2010**

Grant Froelich, Physical Scientist- Pacific Hydrographic Branch

On Sunday, 23 May 2010 (DN 143), *Fairweather* Launch 2807 conducted a dynamic draft measurement (DDM) in Custom House Cove, AK using post processed kinematic GPS data. The vessel sat at rest for approximately 5 minutes, then ran in the South-West direction at approximate speeds of 4, 6, 8, 10 and 12 knots, holding each speed for about 4 minutes. The vessel then turned around and ran in the North-East direction at approximate speeds of 4, 6, 8, 10 and 12 knots, again holding each speed for about 4 minutes and resting for approximately 5 minutes at the end. The POS MV recorded a POSPac file the entire time from beginning rest to finish rest.

The POSPac file was processed with POSPac MMS Software using the GNSS-Inertial Processing Single Base Station Mode. The single *Fairweather* base station SOUTH TWIN (1 Hz) was chosen as the base station. The Lever Arm Standard Deviation was set to <3cm and then the GNSS-Inertial Processor in the Forward, Backward and Combine mode was Run.

The file was then exported out from the POSPac MMS software with an output rate of 1 sec and run through the Pydro script, which includes the fourth order polynomial curve. The following graphs were generated.

Due to the unusually high standard deviation value for 2807 from this run in comparison to the three other *Fairweather* launches, another SBET file was created limiting the speeds examined to 1.0 m/s to 6.6 m/s. This was done to remove the high variation of ellipsoid height data between 0.0 m/s and 1.0 m/s as seen in Figure 2, which occurred for unknown reasons. This speed-clipped file was then run through the Pydro script from GPS seconds of the week 63600 to 64981 to encompass the times of the actual dynamic draft measurement. This produced another set of graphs which included a more reasonable standard deviation value. Because of the missing “at rest” data (0.0 m/s to 1.0 m/s) the best fit equation of the line for this new run varied greatly from the previous run. Based on the results from the other *Fairweather* launches this new run equation of the line was determined to be erroneous due to the lack of “at rest” data which the script is trying to incorporate. The standard deviation plot (Figure 3) does not appear to be affected by this and so the value from this graph (2 STD value of 0.07) was used to update the Delta Draft TPU value in the CARIS HVF on 08/10/2010 but is back dated for use from beginning of the field season.

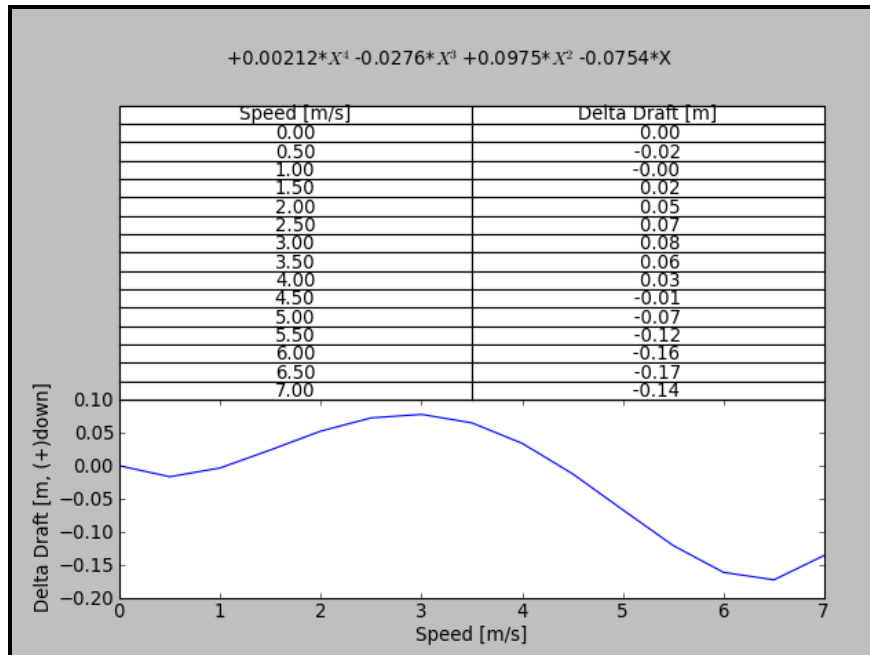

Figure 1. *Fairweather* Launch 2807 Inverted Dynamic Draft Curve & Computed Dynamic Draft Table for CARIS

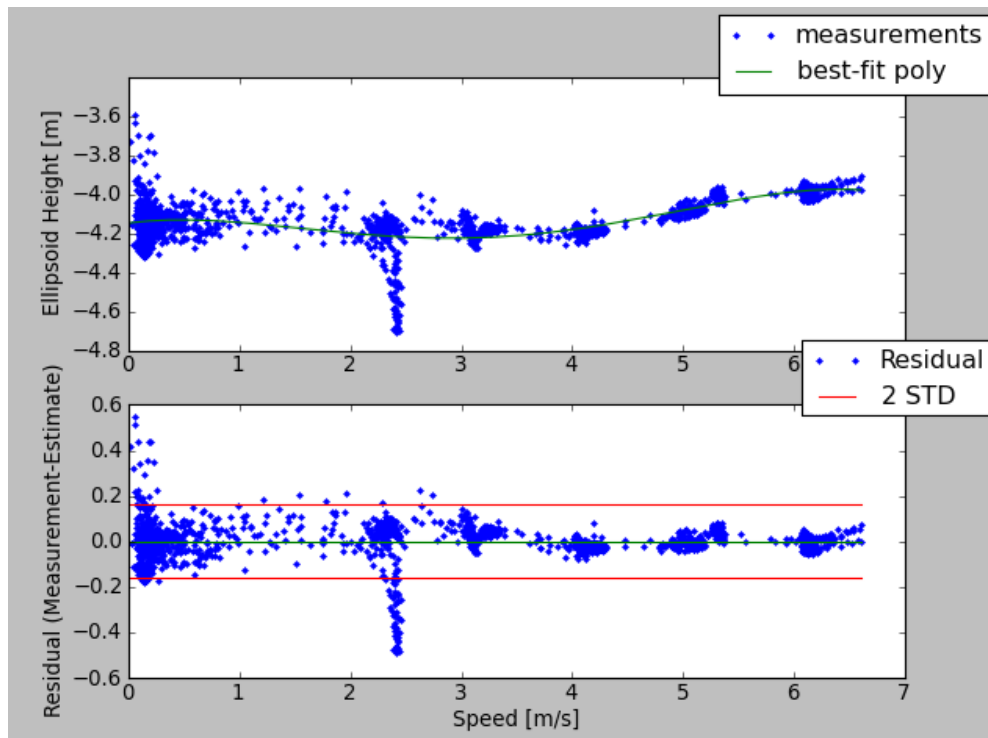

Figure 2. *Fairweather* Launch 2807 Dynamic Draft Curve with Data Points

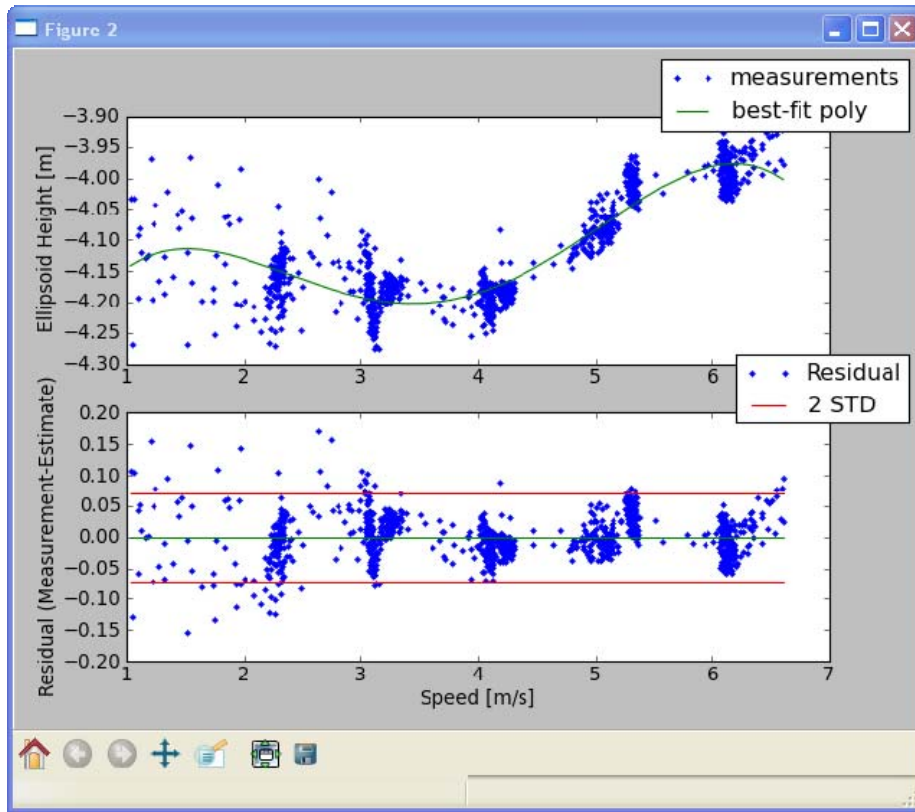

Figure 3. *Fairweather* Launch 2807 Dynamic Draft Curve with Data Points from clipped run

2808 Offsets and Measurements - Summary

| Measurement aka | IMU to RP* | IMU to 7125 (Receiver) <i>SWATH1 x,y,z & MRU to Trans</i> | Port Ant to 7125 <i>Nav to Trans x,y,z</i> | RP* to Waterline | Port Ant to Stbd Ant | IMU to Port Ant | IMU to Heave |
|-----------------|------------|--|---|------------------|-----------------------|-----------------|--------------|
| Coord. Sys. | Caris | Caris | Caris | Caris | | Caris Pos/Mv | Caris Pos/Mv |
| x | 0.000 | 0.004 | 0.685 | n/a | Scaler Distance 1.453 | -0.682 | 0.000 |
| y | 0.000 | 0.250 | 1.086 | n/a | | -0.837 | 0.000 |
| z | 0.000 | 0.477 | 3.637 | -0.123 | | -3.160 | 0.000 |

*IMU is Reference Point

Vessel Offsets for 2808 7125 are derived from the NGS Survey, January 2010, Trimble Equipment Specs, 2010 Measured Values.

Calculations

| Coord. Sys./ Source | IMU to 7125 | Port Ant to 7125 | RP to Waterline | Port Ant to Stbd Ant | IMU to Port Ant | IMU to Heave |
|---------------------|--|--|---|---|---|--|
| NGS | IMU (m) x 0.00000 y 0.00000 z 0.00000 | IMU to x -0.68151 Port Ant (m) y -0.83666 (calculated) z 3.15974 | RP to Waterline (m) (waterline z 0.123 worksheet) | IMU to x -0.68151 Port Ant (m) y -0.83666 (calculated) z 3.15974 | IMU (m) x 0.00000 y 0.00000 z 0.00000 | IMU (m) x 0.00000 y 0.00000 z 0.00000 |
| | MBES RP Rcvr - Phase (m) Center x 0.00351 y 0.24969 z -0.47677 | IMU to x 0.00351 Phase Ctr y 0.24969 (calculated) z -0.47677 | | IMU (m) x, y, z 0.00000 Top of Stbd Ant (m) x 0.77098 y -0.83402 z 3.13235 | Top of Port Ant (m) x -0.68151 y -0.83666 z 3.14844 | Heave Pt (m) x 0.00000 (by design) y 0.00000 z 0.00000 |
| | | | | Base to top of Stbd Ant (eqp spec) (m) z 0.073 Bottom of Stbd Ant (calculated) (m) z 3.05935 Base to Phase Cntr of Stbd Ant (eqp spec) (m) z 0.0843 | Base to top of Port Ant (measured) (m) z 0.073 Bottom of Port Ant (calculated) (m) z 3.07544 Base to Phase Cntr of Port Ant (eqp spec) (m) z 0.0843 | |
| Coord. Sys. NGS | IMU to 7125 IMU to x 0.00351 Phase Ctr y 0.24969 z -0.47677 | Port Ant to 7125 x 0.68502 y 1.08635 z -3.63651 | RP to Waterline x n/a y n/a z 0.123 | Port Ant to Stbd Ant Scalar Distance 1.4526 | IMU to Port Ant x -0.68151 y -0.83666 z 3.15974 | IMU to Heave x 0.00000 y 0.00000 z 0.00000 |
| | Coord. Sys. CARIS x 0.00351 y 0.24969 z 0.47677 | Coord. Sys. CARIS x 0.68502 y 1.08635 z 3.63651 | Coord. Sys. CARIS x n/a y n/a z -0.123 | | Coord. Sys. Pos/Mv x -0.83666 y -0.68151 z -3.15974 | Coord. Sys. Pos/Mv x 0.00000 y 0.00000 z 0.00000 |

Description of Offsets for Launch 2808

All Values Shown are in CARIS Coordinates

The Ship Reference Frame (SRF) for Launch 2808 was based from the IMU reference point as the 0,0,0 point. Physical locations were measured with x,y,z offsets from this point. These locations were used to calculate offsets of items with respect to each other, as described for each offset.

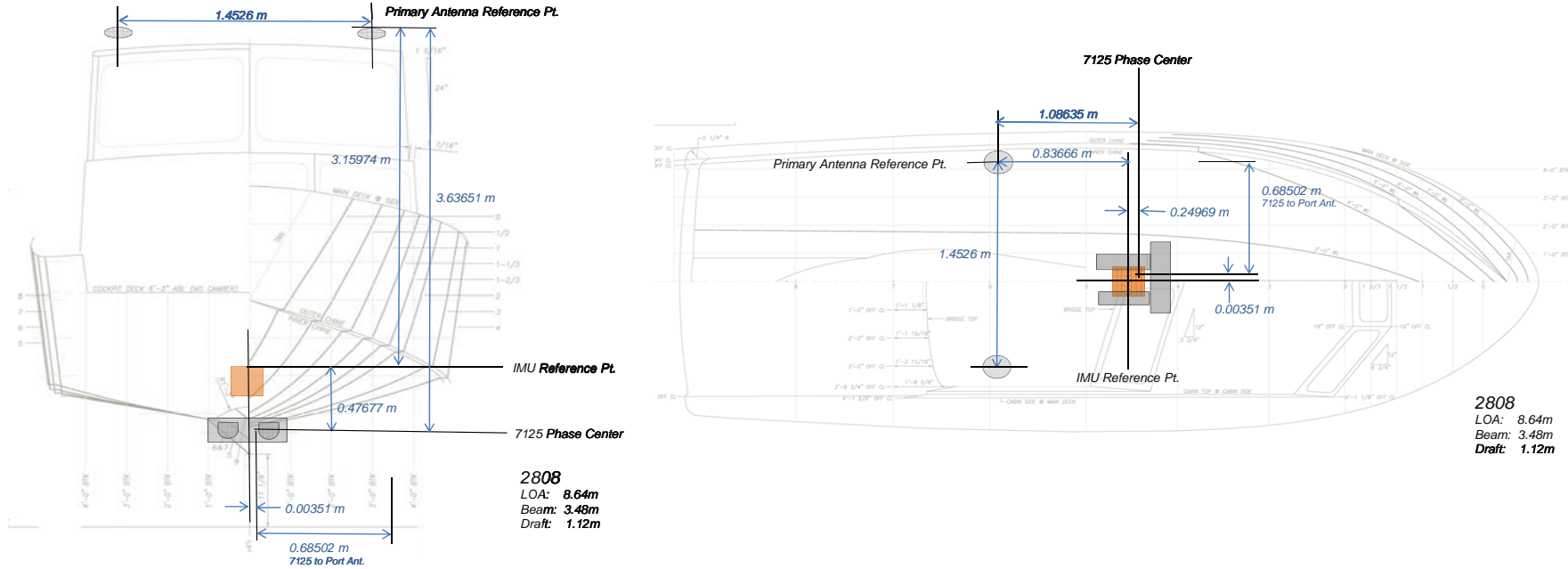

| IMU to 7125 | | |
|-------------|-------|-------|
| x | y | z |
| 0.004 | 0.250 | 0.477 |

The physical positions of the IMU and the receiver phase center of the 7125 were measured during the NGS survey. These physical measurements were taken while the launch was secured on the pier and thought to be as level as possible. The measured values for the IMU and MB were taken directly for the report. The difference is the offset from the IMU to the phase center of the 7125 which was then transposed from the NGS to the CARIS coordinate system.

| Port Ant to 7125 | | |
|------------------|-------|-------|
| x | y | z |
| 0.685 | 1.086 | 3.637 |

The values were calculated by subtracting the of the Port Antenna to the IMU x, y, z values from the respective values of the IMU to the 7125. The calculated values were then transposed from the NGS to the CARIS coordinate system.

| RP to Waterline | | |
|-----------------|-----|--------|
| x | y | z |
| n/a | n/a | -0.123 |

The average vertical distance from Port Benchmark to waterline and the Starboard Benchmark to the waterline were measured by FAIRWEATHER personnel using a steel tape and bubble level. These values were combined with the Z value of the Benchmarks to the RP/IMU to get an average for the waterline to RP. The Waterline Measurement value is in NGS coordinates initially and is converted to CARIS coordinates.

| Port Ant to Stbd Ant | |
|----------------------|--|
| Scalar Distance | |
| 1.453 | |

The location of the phase center of the port and starboard POS/MV antennas were surveyed by NGS. The z-values were adjusted to the phase center. Then the scalar distance between the phase centers was

| IMU to Port Antenna | | |
|---------------------|--------|--------|
| x | y | z |
| -0.682 | -0.837 | -3.160 |

The location of the IMU and the location of the top of port antenna were surveyed by NGS. The z-value of the antenna was calculated by subtracting the height of the antenna and then adding the value from the base of the antenna to the phase center of the antenna. The calculation results were then transposed from the NGS to the CARIS coordinate system.

| IMU to Heave | | |
|--------------|-------|-------|
| x | y | z |
| 0.000 | 0.000 | 0.000 |

The Heave Point is assumed to coincide with the IMU location.

2808
LOA: 8.64m
Beam: 3.48m
Draft: 1.12m

Waterline Measurements

Measuring Party: Beduhn, Francksen, Froelich
2808

Waterline measurements should be negative and cm!

| | 2808 | |
|------------------------------|-----------------------------|-----------------------------|
| | Port Benchmark to Waterline | Stbd Benchmark to Waterline |
| Measure 1 | -93.4 | -95.2 |
| Measure 2 | -93.2 | -92.2 |
| Measure 3 | -92.9 | -95.2 |
| Avg (cm) | -93.17 | -94.20 |
| Avg (m) | -0.9317 | -0.9420 |
| Stdev | 0.00252 | 0.01732 |
| BM Z-value (m)* | 1.07600 | 1.04444 |
| BM to WL (m) | 0.144 | 0.102 |
| Individual measurement | 0.14200 | 0.09244 |
| | 0.14400 | 0.12244 |
| StDev for TPU xls (of 6 #'s) | 0.025476 | 0.09244 |

Measuring Party: Beduhn, Francksen, Froelich
2808

Waterline measurements should be negative and cm!

| | 2808 | |
|------------------------------|-----------------------------|-----------------------------|
| | Port Benchmark to Waterline | Stbd Benchmark to Waterline |
| Measure 1 | -92.2 | -93.1 |
| Measure 2 | -93.8 | -91.0 |
| Measure 3 | -93.4 | -92.5 |
| Avg (cm) | -93.13 | -92.20 |
| Avg (m) | -0.9313 | -0.9220 |
| Stdev | 0.00833 | 0.01082 |
| BM Z-value (m) | 1.07600 | 1.04444 |
| BM to WL (m) | 0.14466667 | 0.122 |
| Individual measurement | 0.15400 | 0.11344 |
| | 0.13800 | 0.13444 |
| StDev for TPU xls (of 6 #'s) | 0.014925 | 0.11944 |

Fill in Yellow squares only!

Date: 3/5/2010
 Fuel Level: 3/4 Full
 Draft Tube:

Port-to-Stbd Z-difference
 Theoretical Actual Error
 0.0316 -0.0103 -0.0419

RP to WL Average (m)
 0.123 NGS Coordinate System (do not enter into CARIS directly)
 (Add this value to VSSL_Offsets & Measurements_20XX.xls)

utilized in Offsets and Measurements and TPU spreadsheet

Date: 3/5/2010
 Fuel Level: 1/2 port ~1/2 star
 Draft Tube:

Port-to-Stbd Z-difference
 Theoretical Actual Error
 0.0316 0.0093 -0.0222

RP to WL Average (m)
 0.134 NGS Coordinate System (do not enter into CARIS directly)
 (or add this value to VSSL_Offsets & Measurements_20XX)

US DEPARTMENT OF COMMERCE
NATIONAL OCEANIC & ATMOSPHERIC ADMINISTRATION
NATIONAL OCEAN SERVICE
NATIONAL GEODETIC SURVEY
GEODETIC SERVICES DIVISION
INSTRUMENTATION & METHODOLOGIES BRANCH

**NOAA SURVEY VESSEL 2808
POS MV COMPONENTS SPATIAL RELATIONSHIP
SURVEY
FIELD REPORT**

Kendall L. Fancher
January, 2010



**NOAA SURVEY VESSEL 2808
POS MV COMPONENTS SPATIAL RELATIONSHIP SURVEY**

PURPOSE

The primary purpose of the survey was to precisely determine the spatial relationship between various hydrographic surveying sensors, launch bench marks and the components of a POS MV navigation system aboard the NOAA survey vessel 2808.

PROJECT DETAILS

This survey was conducted in Seattle, WA at the NOAA Western Center on the 27th of January, 2010. The weather was foggy then sunny with temperatures in the 40s to 50s. For this survey, the vessel was on blocks, supported by boat jacks. The vessel was reported to have been leveled relative to the IMU.

INSTRUMENTATION

A Leica TDA5005 precision total station was used to make all measurements.

Technical Data:

| Standard Deviation | |
|----------------------|-------------|
| Horizontal angle | 0.5 seconds |
| Vertical angle | 0.5 seconds |
| Distance measurement | 1mm + 1ppm |

Leica precision prisms were used as sighting targets. Prisms were configured to have a zero mm offset.

PERSONNEL

Kendall Fancher NOAA/NOS/NGS/GSD/I&M BRANCH
(540) 373-1243
kendall.fancher@noaa.gov

Dennis Lokken NOAA/NOS/NGS/GSD/I&M BRANCH
(540) 373-1243
dennis.lokken@noaa.gov

**NOAA SURVEY VESSEL 2808
POS MV COMPONENTS SPATIAL RELATIONSHIP SURVEY**

DEFINITION OF THE REFERENCE FRAME

For this survey, data was collected in a 3-D right handed Cartesian coordinate system. The origin of this coordinate system is defined as the center of the IMU target. The Y (Northing) axis is parallel to the centerline of the launch and is positive towards the bow of the launch. The X (Easting) axis is perpendicular to the Y axis and is positive towards the starboard side of the launch. The Z (Elevation) axis is perpendicular to the XY plane and is positive towards the top of the launch. The coordinates of the points established this survey are reported in this coordinate system and are provided in Appendix A.

SURVEY METHODOLOGY

Four temporary control points, (1, 2, 3, and 4), were established around the vessel such that every point to be positioned on the launch could be observed from at least two separate locations.

Coordinates of 100.000N, 100.000E, and 100.000U were assumed for temporary control point 1. A distance and height difference were measured between control points 1 and 2. Temporary control point 2 was assumed to have an Easting of 100.000. The measured distance between these two points was used to determine the Northing for temporary control point 2. The height difference between the two points was used to determine the Up component for control point 2.

Control point 1 was occupied and control point 2 was observed to initialize the instrument. After initialization, control point 4 and all visible points to be observed on the launch were observed in both direct and reverse. The stability of the instrument setup was checked at conclusion of the data set collection by checking back to temporary control point 2.

Control point 2 was occupied and control point 1 was observed to initialize the instrument. After initialization, control point 3 and all visible points to be observed on the launch were observed in both direct and reverse. The stability of the instrument setup was checked at conclusion of the data set collection by checking back to temporary control point 1.

Control point 3 was occupied and control point 2 was observed to initialize the instrument. After initialization, control point 4 and all visible points to be observed on the launch were observed in both direct and reverse. The stability of the instrument setup was checked at conclusion of the data set collection by checking back to temporary control point 2.

NOAA SURVEY VESSEL 2808 POS MV COMPONENTS SPATIAL RELATIONSHIP SURVEY

Control point 4 was occupied and control point 3 was observed to initialize the instrument. After initialization, all visible points to be observed on the launch were observed in both direct and reverse. Control point 1 was also observed in order to evaluate the accuracy of the traverse. Inverse computations between the original and observed control point yielded a horizontal accuracy, or traverse closure of 0.001m and a vertical accuracy of 0.000m. The stability of the instrument setup was checked at conclusion of the data set collection by checking back to temporary control point 2.

Inverses were computed between the two positions determined for all points surveyed to evaluate their accuracy relative to the temporary control network. Inverse reports are included in appendix B.

The reference frame was rotated using CENTERLINE STERN BM (CLS) as the point of rotation. A zero degree azimuth was used during the rotation from CLS to CENTERLINE BOW BM (BMB). The reference frame was then translated to relocate the origin of the reference frame to the IMU. The resulting coordinates are reported in appendix A.

DISCUSSION

The positions given for the POS GPS antennas (Zephyr Model II p/n 57970-00) are to the top center of the antenna. To correct the Z value provided in this report for each antenna to the electronic phase center, I recommend the following steps be taken;

- 1) Determine the physical height of the GPS antenna. This information is probably located on the antenna or with equipment documentation.
- 2) Investigate to find the electronic phase center offset of the antenna. This information is probably located on the antenna or with equipment documentation. This value may also be available at the NGS website for antenna modeling.
- 3) Subtract the total height of the antenna from the Z value for each antenna. This will give you a Z value for the antenna ARP (antenna reference point)
- 4) Then add to this value the electronic phase center offset value appropriate for the antenna model.



NOAA SURVEY VESSEL 2808 POS MV COMPONENTS SPATIAL RELATIONSHIP SURVEY

Two reference points (MBF and MBA) were positioned in order to facilitate future measurements to the Multi-Beam sensor by launch personnel. These reference points are punch marks set along the center of the keel, at the locations described in the image at right.



A point on the Multi-Beam transducer (MB) was measured directly this survey. The measured point was at the center of the bottom of the transducer. No mark was left to indicate the measured point.

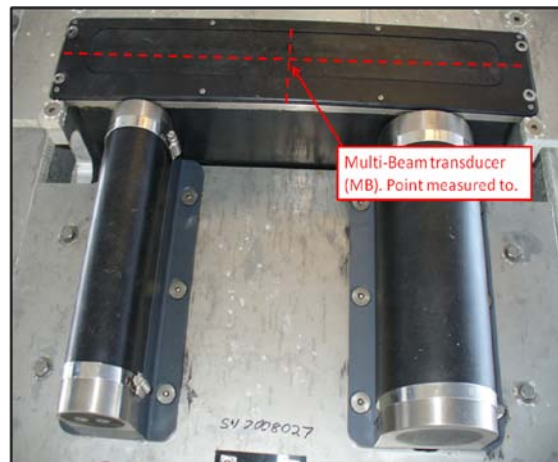

The point positioned for the Inertial Motion Unit (IMU) this survey was the center of the target affixed to the top of the unit. Additionally, a reference mark (IMUR) was established on the plate the IMU is attached to at a point where two scribed lines intersect, forward of the IMU.

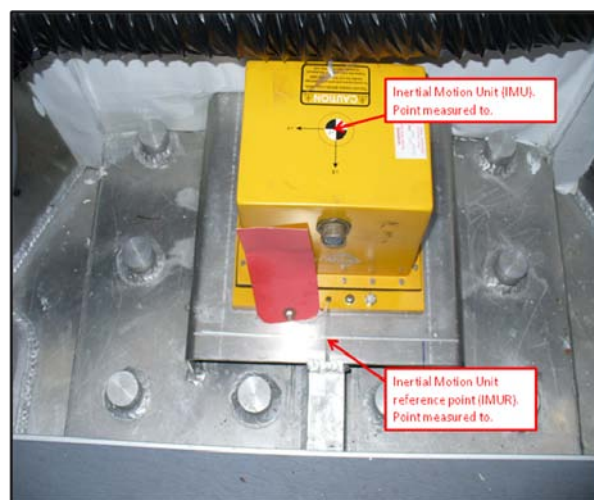

NOAA SURVEY VESSEL 2808
POS MV COMPONENTS SPATIAL RELATIONSHIP SURVEY

STATION LISTING

| | |
|-------|---|
| BMB- | CENTERLINE BOW BM The center of a cross mark inscribed into the top of a square metal flange, welded to the deck, along the centerline and near the bow of the launch. |
| CLS- | CENTERLINE STERN BM The center of a cross mark inscribed into the top of a square metal flange, welded to the deck, along the centerline and near the stern of the launch. |
| BMP- | PORT SIDE BM The center of a cross mark inscribed into the top of a square metal flange, welded to the top of the deck, near the middle of and along the port side of the launch. |
| BMS- | STARBOARD SIDE BM The center of a cross mark inscribed into the top of a square metal flange, welded to the top of the deck, near the middle of and along the starboard side of the launch. |
| MBF- | KEEL BM A punch mark set along the bottom center of the keel, fore of the multi-beam transducer, 0.030 m from a point where the keel makes a 90 degree angle upwards. |
| MBA- | KEEL BM A punch mark set along the bottom center of the keel, aft of the multi-beam transducer, 0.030 m from a point where the keel makes a 90 degree angle upwards. |
| IMU- | IMU TARGET Center of a target affixed to the top of the IMU housing. |
| IMUR- | IMU REFERENCE BM The intersection of two scribed lines atop a metal support plate for the IMU and forward of the IMU. |
| GPSP- | PORT SIDE GPS ANTENNA REFERENCE POINT The top center of the port side GPS antenna for the POS system. |
| GPSS- | STARBOARD GPS ANTENNA REFERENCE POINT The top center of the starboard side GPS antenna for the POS system. |
| MB- | MULTI-BEAM REFERENCE POINT The physical bottom center of the Multi-Beam transducer. |

Appendix A

Coordinate Report Launch 2808

| <i>Pt Name</i> | <i>North(Y)</i> | <i>East(X)</i> | <i>UP(Z)</i> | <i>ID</i> |
|-------------------------------|-----------------|----------------|--------------|-----------|
| IMU Target | 0.00000 | 0.00000 | 0.00000 | IMU |
| IMU Reference BM | 0.13282 | -0.00186 | -0.16518 | IMUR |
| Centerline Stern BM | -4.07730 | 0.01391 | 0.61506 | CLS |
| Centerline Bow BM | 3.44544 | 0.01391 | 1.44047 | BMB |
| Portside GPS Ant. Ref. Point | -0.83666 | -0.68151 | 3.14844 | GPSP |
| Starboard GPS Ant. Ref. Point | -0.83402 | 0.77098 | 3.13235 | GPSS |
| Multi-Beam Ref.Point | 0.24969 | 0.00351 | -0.47677 | MB |
| Keel BM | 0.44021 | -0.00126 | -0.60545 | MBF |
| Keel BM | -0.22600 | 0.00192 | -0.53583 | MBA |
| Port Side BM | 0.08204 | -1.42963 | 1.07600 | BMP |
| Starboard Side BM | 0.08324 | 1.46250 | 1.04444 | BMS |

Units = meters

Appendix B

Point to Point Inverse Launch 2808

| <i>Pt. 1</i> | <i>Pt. 2</i> | <i>Dist.</i> | <i>Northing</i> | <i>Easting</i> | <i>Elevation</i> | <i>ID</i> |
|--------------|--------------|--------------|-----------------|----------------|------------------|-----------|
| 3 | 40 | 0.001 | -0.001 | 0.000 | 0.00026 | MBF |
| 5 | 42 | 0.003 | -0.002 | -0.001 | 0.00013 | MBA |
| 4 | 41 | 0.002 | -0.001 | -0.002 | 0.00062 | MB |
| 14 | 55 | 0.006 | -0.005 | 0.004 | 0.00049 | IMUR |
| 13 | 56 | 0.006 | -0.004 | 0.004 | 0.00055 | IMU |
| 43 | 6 | 0.001 | 0.000 | 0.001 | 0.00048 | CLS |
| 33 | 44 | 0.000 | 0.000 | 0.000 | 0.00006 | BMS |
| 8 | 22 | 0.001 | -0.001 | 0.000 | 0.00039 | BMP |
| 17 | 25 | 0.005 | 0.000 | 0.005 | 0.00011 | BMB |
| 24 | 34 | 0.001 | 0.000 | 0.000 | 0.00049 | GPSS |
| 23 | 7 | 0.000 | 0.000 | 0.000 | 0.00022 | GPSP |

Units = meters

FAIRWEATHER**Multibeam Echosounder Calibration****Launch 2808 200kHz**

Vessel

Froelich, Francksen, Beduhn, Brooks

Calibrating Hydrographer(s)

| | | |
|-----------------------------------|----------------------|--|
| Reson 7125 | Launch 2808 | 10/09/2009 |
| MBES System | MBES System Location | Date of most recent EED/Factory Check |
| TBD | | CD0001529704 |
| Sonar Serial Number | | Processing Unit Serial Number |
| Plate mounted on hull | | 1/27/2010 |
| Sonar Mounting Configuration | | Date of current offset measurement/verification |
| DGPS Beacon 323, POSMV V4 | | 3/4/2010 |
| Description of Positioning System | | Date of most recent positioning system calibration |

Acquisition Log

| | | | |
|-------------|-----|-------------------|-------------------------|
| 3/5/2010 | 064 | Shilshole Bay, WA | Clear, Calm |
| Date | Dn | Local Area | Wx |
| Mixed | | | 15m |
| Bottom Type | | | Approximate Water Depth |

Froelich, Francksen, Beduhn, Brooks

Personnel on board

Comments

2009_064_2808.000

TrueHeave filename

| | | | | |
|---------------------|---------------|--------------|-------|------------|
| 10064181.4ex | 47 40 32.34 | 122 25 23.33 | | |
| SV Cast #1 filename | Lat | Lon | Depth | Ext. Depth |
| 10064205.2ex | 47 40 30.5603 | 122 25 24.75 | | |
| SV Cast #2 filename | Lat | Lon | Depth | Ext. Depth |

view parallel to track, one line with induced roll (outerbeam) or same lines bounded slope (nadir)
 [same direction, different speed]

NAV TIME LATENCY

| SV Cast # | XTF Line Filename | Heading | Speed (kts) | Remarks |
|-----------|-------------------|---------|-------------|-----------------------------|
| 1 | 2010_0641859 | 240 | 6.0 | Good line |
| | 1901 | 240 | | not enough roll delete line |
| | 1903a | 240 | | |
| | 1905 | 068 | | Good line |
| | | | | |
| | | | | |
| | | | | |
| | | | | |

PITCH view parallel to track, same line (at nadir) [opposite direction, same speed]

| SV Cast # | XTF Line Filename | Heading | Speed (kts) | Remarks |
|-----------|-------------------|---------|-------------|----------|
| 1 | 2010_0641909 | 132 | 6.0 | line 103 |
| | 1910 | 312 | | |
| | 1911 | 132 | | |
| | 1912 | 312 | | |
| | | | | |
| | | | | |
| | | | | |
| | | | | |

HEADING/YAW view parallel to track, offset lines (outerbeams) [opposite direction, same speed]

| SV Cast # | XTF Line Filename | Heading | Speed (kts) | Remarks |
|-----------|-------------------|---------|-------------|------------------|
| 1 | 2010_0641914 | 132 | 6.0 | line 104 |
| | 1915 | 312 | | line 101 |
| | 1916 | 132 | | 101 questionable |
| | 1917 | 312 | | line 104 |
| | | | | |
| | | | | |
| | | | | |
| | | | | |

ROLL view across track, same line [opposite direction, same speed]

| SV Cast # | XTF Line Filename | Heading | Speed (kts) | Remarks |
|-----------|-------------------|---------|-------------|---------|
| 1 | 2010_0641919 | 060 | 6.0 | line 1 |
| | 1922 | 240 | | |
| | 1924 | 060 | | |
| | 1927 | 240 | | |
| | | | | |
| | | | | |
| | | | | |
| | | | | |

Processing Log

3/10/2010 | | Beduhn

Date | Dn | Personnel

Data converted --> HDCS_Data in CARIS

TrueHeave applied 2009_064_2808.000

SVP applied 2010_064_2808.000

Tide applied N395RA2009.tc predicted

Zone file _____

Lines merged

Data cleaned to remove gross fliers

Compute correctors in this order

1. Precise Timing 2. Pitch bias 3. Heading bias 4. Roll bias

Do not enter/apply correctors until all evaluations are complete and analyzed.

PATCH TEST RESULTS/CORRECTORS

| Evaluators | Latency (sec) | Pitch (deg) | Roll (deg) | Yaw (deg) |
|---------------------------|---------------|-------------|------------|-----------|
| SST Beduhn | 0.00 | -2.10 | 0.23 | 0.60 |
| AST Mallory | 0.00 | -2.10 | 0.27 | 0.85 |
| LT Welton | 0.00 | -1.95 | 0.27 | 0.90 |
| PS Froelich | 0.00 | -2.20 | 0.34 | 0.90 |
| | | | | |
| | | | | |
| | | | | |
| | | | | |
| | | | | |
| Averages | 0.00 | -2.09 | 0.28 | 0.81 |
| Standard Deviation | 0.00 | 0.10 | 0.05 | 0.14 |
| FINAL VALUES | 0.00 | -2.09 | 0.28 | 0.81 |

Final Values based on Averages

Resulting HVF File Name FA_2808_200kHz_Rsn7125_256bms

MRU Align StdDev gyro 0.14 Value from standard deviation of Heading offset values

MRU Align StdDev Roll/Pitch 0.07 Value from averaged standard deviations of pitch and roll offset values

NARRATIVE

HVF Hydrographic Vessel File created or updated with current offsets

Name: CST/FOO

Date: 03/30/2010

FAIRWEATHER

Multibeam Echosounder Calibration

Launch 2808 400kHz

Vessel

3/5/2010 | 064 | Shilshoal Bay, WA
Date Dn Local Area

Froelich, Francksen, Beduhn, Brooks
Calibrating Hydrographer(s)

Reson 7125 400kHz | Launch 2808 |
MBES System MBES System Location Date of most recent EED/Factory Check

| CD0001529704
Sonar Serial Number Processing Unit Serial Number

Plate mounted on hull |
Sonar Mounting Configuration Date of current offset measurement/verification

DGPS Beacon 323, POSMV V4 |
Description of Positioning System Date of most recent positioning system calibration

Acquisition Log

3/5/2010 | 064 | Shilshoal | Clear, Calm
Date Dn Local Area Wx

Mixed | 15m
Bottom Type Approximate Water Depth

Froelich, Francksen, Beduhn, Brooks
Personnel on board

All lines were collected at 6-6.5 kts unless otherwise noted
Comments

2009_064_2808.000
TrueHeave filename

10064181.4ex | | 47 40 32.34 | 122 25 23.33 | |
SV Cast #1 filename L Lat Lon Depth Ext. Depth

10064205.2ex | | 47 40 30.5603 | 122 25 24.75 | |
SV Cast #2 filename L Lat Lon Depth Ext. Depth

view parallel to track, one line with induced roll (outerbeam) or same lines bounded slope (nadir)
 [same direction, different speed]

NAV TIME LATENCY

| SV Cast # | XTF Line Filename | Heading | Speed (kts) | Remarks |
|-----------|-------------------|---------|-------------|--------------|
| 1 | 2010_0642026 | 060 | 6.0 | induced roll |
| | 2028 | 240 | 6.0 | induced roll |
| | | | | |
| | | | | |
| | | | | |
| | | | | |
| | | | | |
| | | | | |

PITCH view parallel to track, same line (at nadir) [opposite direction, same speed]

| SV Cast # | XTF Line Filename | Heading | Speed (kts) | Remarks |
|-----------|-------------------|---------|-------------|----------|
| 1 | 2010_0642031 | 125 | 6.0 | line 103 |
| | 2032 | 312 | 6.0 | |
| | 2033 | 125 | 6.0 | |
| | 2034 | 312 | 6.0 | |
| | | | | |
| | | | | |
| | | | | |
| | | | | |
| | | | | |

HEADING/YAW view parallel to track, offset lines (outerbeams) [opposite direction, same speed]

| SV Cast # | XTF Line Filename | Heading | Speed (kts) | Remarks |
|-----------|-------------------|---------|-------------|-----------------------|
| 1 | 2010_0642036 | 132 | 6.0 | line 104 |
| | 2037 | 312 | 6.0 | line 101 |
| | 2038 | 132 | 6.0 | line 101, better line |
| | 2039 | 312 | 6.0 | line 104, better line |
| | | | | |
| | | | | |
| | | | | |
| | | | | |

ROLL view across track, same line [opposite direction, same speed]

| SV Cast # | XTF Line Filename | Heading | Speed (kts) | Remarks |
|-----------|-------------------|---------|-------------|---------|
| 1 | 2010_0642040 | 060 | 6.0 | line 1 |
| | 2044 | 240 | 6.0 | |
| | 2046 | 060 | 6.0 | |
| | 2049 | 240 | 6.0 | |
| | | | | |
| | | | | |
| | | | | |
| | | | | |

Processing Log

3/10/2010 | | Beduhn, Welton
 Date Dn Personnel

Data converted --> HDCS_Data in CARIS

TrueHeave applied 2009_064_2808.000

SVP applied 2010_064_2808.000

Tide applied N395RA2009.tc predicted

Zone file _____

Lines merged

Data cleaned to remove gross fliers

Compute correctors in this order

1. Precise Timing 2. Pitch bias 3. Heading bias 4. Roll bias

Do not enter/apply correctors until all evaluations are complete and analyzed.

PATCH TEST RESULTS/CORRECTORS

| Evaluators | Latency (sec) | Pitch (deg) | Roll (deg) | Yaw (deg) |
|---------------------------|---------------|-------------|------------|-----------|
| SST Beduhn | 0.00 | -1.20 | 0.38 | -0.16 |
| CST Morgan | 0.00 | -2.24 | 0.40 | 1.00 |
| LT Welton | 0.00 | -1.50 | 0.36 | ? +/- .4 |
| PS Froelich | 0.00 | -2.20 | 0.38 | -0.50 |
| | | | | |
| | | | | |
| | | | | |
| | | | | |
| | | | | |
| | | | | |
| Averages | 0.00 | -1.79 | 0.38 | 0.11 |
| Standard Deviation | 0.00 | 0.52 | 0.02 | 0.79 |
| FINAL VALUES | | | | |

Final Values based on averages, questionable range value not included

Resulting HVF File Name FA_2808_400kHz_Rsn7125_512bms_2010

MRU Align StdDev gyro 0.79 Value from standard deviation of Heading offset values
 MRU Align StdDev Roll/Pitch 0.27 Value from averaged standard deviations of pitch and roll offset values

NARRATIVE

HVF Hydrographic Vessel File created or updated with current offsets

Name: _____

Date: _____

FAIRWEATHER
Multibeam Echosounder Calibration

Launch 2808 400kHz

Vessel

| | | |
|----------|-----|-------------------|
| 4/5/2010 | 095 | Shilshoal Bay, WA |
| Date | Dn | Local Area |

Beduhn, Hedgepeth, Allen
 Calibrating Hydrographer(s)

| | | |
|-------------------|----------------------|---------------------------------------|
| Reson 7125 400kHz | Launch 2808 | 10/09/2009 |
| MBES System | MBES System Location | Date of most recent EED/Factory Check |

| | |
|---------------------|-------------------------------|
| TBD | CD0001529704 |
| Sonar Serial Number | Processing Unit Serial Number |

| | |
|------------------------------|---|
| Plate mounted on hull | 1/27/2010 |
| Sonar Mounting Configuration | Date of current offset measurement/verification |

| | |
|-----------------------------------|--|
| DGPS Beacon 323, POSMV V4 | 3/4/2010 |
| Description of Positioning System | Date of most recent positioning system calibration |

Acquisition Log

| | | | |
|----------|-----|------------|-------------|
| 4/5/2010 | 095 | Shilshoal | Clear, Calm |
| Date | Dn | Local Area | Wx |

| | |
|-------------|-------------------------|
| Mixed | 15m |
| Bottom Type | Approximate Water Depth |

Beduhn, Hedgepeth, Allen
 Personnel on board

Clear < 1' chop
 Comments

2009_095_2808.000
 TrueHeave filename

| | | | | | |
|---------------------|----------|-------------|---------------|-------|------------|
| 100641814.svp | 1814 | 47:40:32.34 | -122:25:23.33 | 35 | |
| SV Cast #1 filename | UTC Time | Lat | Lon | Depth | Ext. Depth |

| | | | | | |
|---------------------|----------|-----|-----|-------|------------|
| | | | | | |
| SV Cast #2 filename | UTC Time | Lat | Lon | Depth | Ext. Depth |

Fairweather Launch 2808 Dynamic Draft Measurement Lake Washington, 03 March 2010

LTjg Caryn Arnold, HSTP West Coast Field Support Liaison

On Wednesday, 03 March 2010 (DN 063), *Fairweather* Launch 2808 conducted a dynamic draft measurement (DDM) on Lake Washington using post processed kinematic GPS data. The vessel sat at rest for approximately 5 minutes, then ran in the South direction at approximate speeds of 4, 6, 8 and 10 knots, holding each speed for about 4 minutes. The vessel then turned around and ran in the North direction at approximate speeds of 10, 8, 6 and 4 knots, again holding each speed for about 4 minutes and resting for approximately 5 minutes at the end. The POS/MV recorded a POSpac file the entire time from beginning rest to finish rest.

The POSpac file was processed with POSpac MMS Software using the GNSS-Inertial Processing Single Base Station Mode. The single CORS station SEAI (1 Hz) was chosen as the base station. The Lever Arm Standard Deviation was set to <3cm and then the GNSS-Inertial Processor in the Forward, Backward and Combine mode was Run.

The file was then exported out from the POSpac MMS software with an output rate of 1 sec and run through the Python Script written by LTjg Glen Rice, which includes the fourth order polynomial curve. The following graphs were generated.

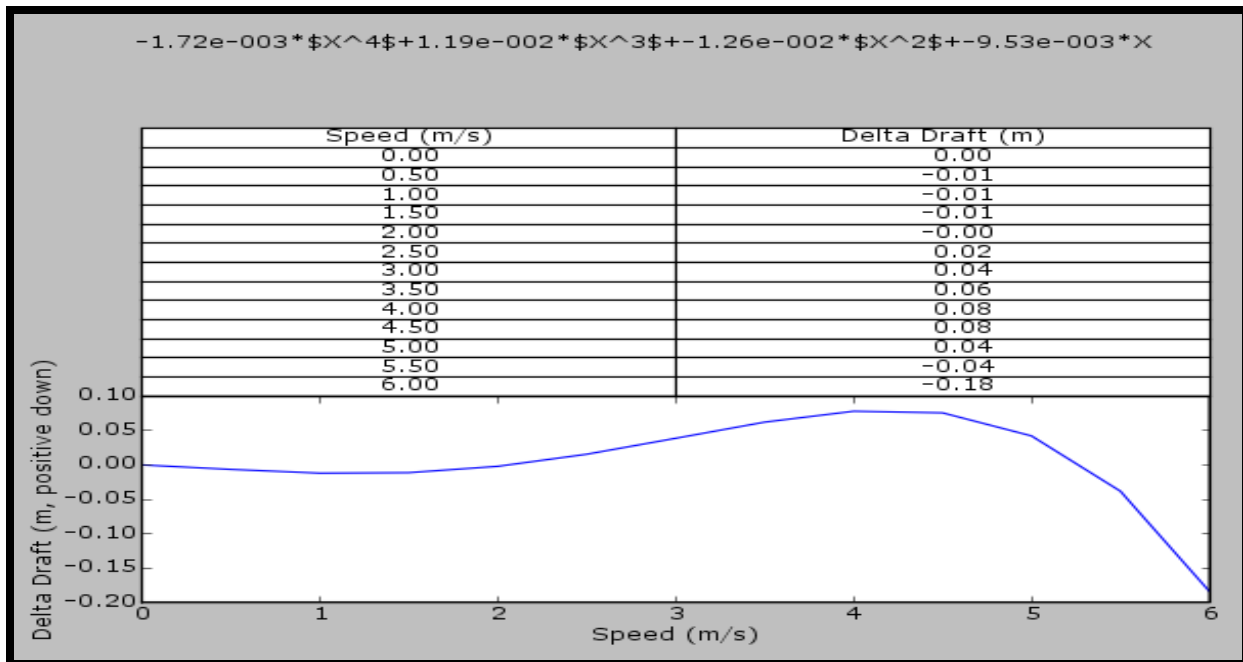

Figure 1. *Fairweather* Launch 2808 Inverted Dynamic Draft Curve & Computed Dynamic Draft Table for Caris

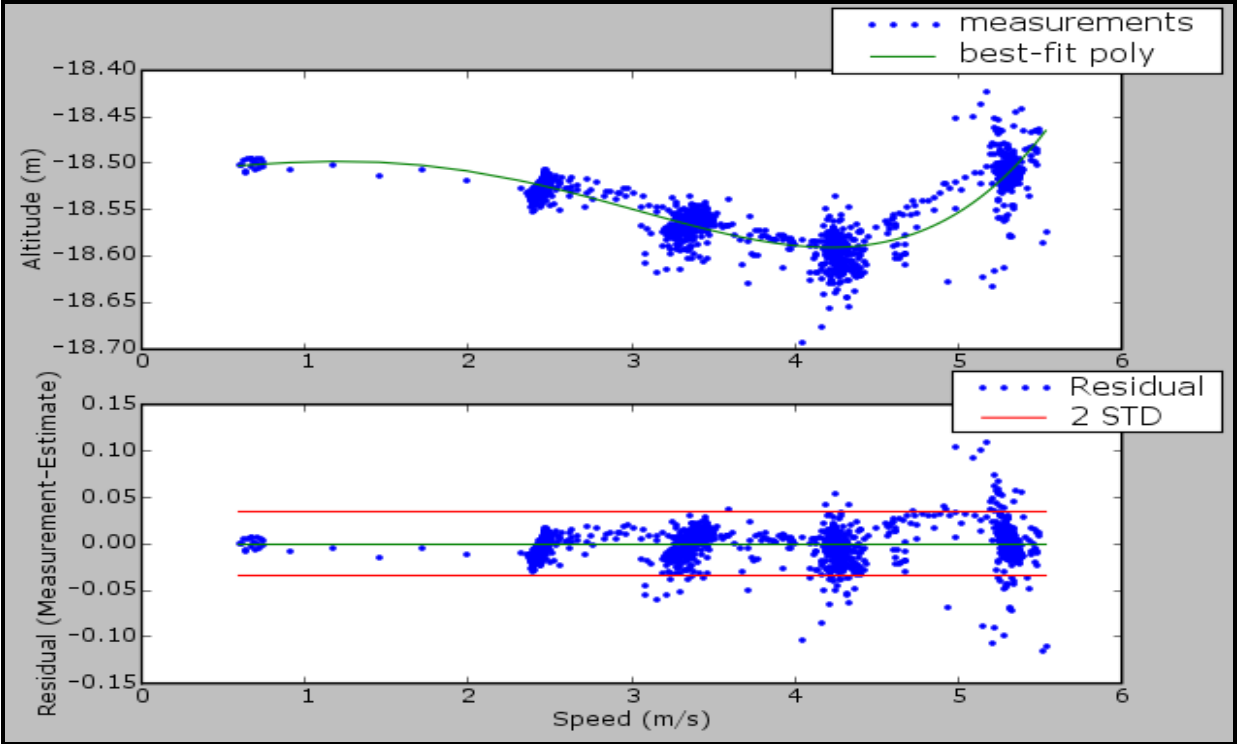

Figure 2. Fairweather Launch 2808 Dynamic Draft Curve with Data Points

S220 Offsets and Measurements - Summary

| Measurement Coord. Sys. | IMU to 7/8111 (MRU to Trans) | | Port Ant to 7/8111 (Nav to Trans) | | Waterline to RP* | | Port Ant to Stbd Ant | | IMU to Port Ant | | IMU to Heave | |
|-------------------------|------------------------------|--------|-----------------------------------|-------|------------------|-------|----------------------|---------|-----------------|--------|--------------|--------|
| | | Caris | | Caris | | Caris | | | Caris | Pos/Mv | Caris | Pos/Mv |
| x | 2.868 | 2.071 | | n/a | Scaler Distance | 1.997 | | 0.797 | -11.892 | 1.866 | -7.028 | |
| y | 8.252 | 20.144 | | n/a | | | | -11.892 | 0.797 | -7.028 | 1.866 | |
| z | 4.430 | 17.499 | | 0.014 | | | | 13.068 | -13.068 | -2.086 | -2.086 | |

*Top of IMU is RP (Reference Pt)

2010 Measured Value

Vessel Offsets for S220 7111 are derived from Westlake Survey Report NOAA Fairweather 09-23-03, Fairweather Centerline Survey (NGS) Report March 2009, and measurements by FA personeo

Calculations

| Coordinate Systems used as listed | IMU to 7/8111 | Port Ant to 7/8111 | Waterline to RP* | Port Ant to Stbd Ant | IMU to Port Ant | IMU to Heave |
|--|---|--|--|--|--|--|
| | Westlake | NGS | Westlake | NGS | NGS | Westlake |
| IMU Base | easting 0.000 northing 0.000 (ft/m) elevation 0.000 | Top of IMU to Port Ant x -11.892 y 0.797 (m) z 13.068 | IMU Base to baseline at Keel (ft) elevation 12.856 IMU Base to baseline at Keel (m) elevation 3.919 | Phase Center x -11.892 Port Ant y 0.797 (m) z 13.068 | IMU Top (m) x 0.000 y 0.000 z 0.000 | IMU to Bulkhd (Frame) 52 (ft) easting -11.638 (m) easting -3.547 |
| 8111 (from IMU Base to sensor) easting 27.072 (ft) northing 9.410 elevation 15.042 | CARIS Port Ant x 0.797 y -11.892 (m) z -13.068 | Waterline to Keel (ft) elevation 13.45 Waterline to Keel (m) elevation 4.100 | Top of old Stbd Ant (pre-2010) x -11.886 y 2.794 (m) z 13.051 | Top of old Port Ant (pre-2010) x -11.892 y 0.797 (m) z 13.047 | Frame 0 (FP) to Frame 52 (m) easting -27.737 | Top of IMU to Base of IMU (m) elevation 0.168 Top of IMU to Keel (m) elevation 4.086 |
| 8111 (from IMU Base to sensor) easting 8.252 (m) northing 2.868 elevation 4.585 | Westlake Top of IMU to 8111 (m) easting 8.252 northing 2.868 elevation 4.430 | <i>See Ship's Draft Spreadsheet</i> Top of IMU to Base of IMU (m) elevation 0.168 Top of IMU to Keel (m) 4.086 | Top to Base of Old (pre-2010) Ant measured (in) z 2.477 (m) z 0.0629 | Top to Base of Old (pre-2010) Ant measured (in) z 2.477 (m) z 0.0629 | Heave Pt* to Frame 0 (FP) (ft) easting 102.42 (m) easting 31.218 | Center of Gravity above baseline (ft) elevation 16.37 Mean Metacentric height (ft) elevation 3.88 |
| Base of IMU to Top of IMU (m) elevation -0.168 | CARIS Top of IMU to 8111 (m) x 2.868 y 8.252 z 4.430 | Top of IMU to Base of IMU (m) 4.086 | Top of Stbd Ant Post x -11.886 y 2.794 (m) z 12.988 | Top of Port Ant Post x -11.892 y 0.797 (m) z 12.984 | IMU to Centerline (ft) northing 6.122 (m) northing 1.866 | Heave Pt* to baseline at Keel (ft) elevation 20.25 (m) elevation 6.172 |
| Correction based on Ref Surface (m) elevation -0.322 | | | Base to Phase Ctr New(2010) Ant listed on Ant(m) z 0.0843 | Base to Phase Ctr New(2010) Ant listed on Ant (m) z 0.0843 | Heave Pt* to Centerline (m) northing 0 | (*Heave Pt is Metacenter) (FP is Forward Perpendicular) |
| Coord Sys. CARIS | Coord Sys. CARIS | Coord. Sys CARIS | Coord. Sys CARIS | Coord. Sys. POS/MV | Coord. Sys. POS/MV | Coord. Sys. POS/MV |
| x 2.868 y 8.252 z 4.430 | x 2.071 y 20.144 z 17.499 | x N/A y N/A z 0.014 | x N/A y N/A z 0.014 | x -11.892 y 0.797 z -13.068 | x -11.892 y 0.797 z -13.068 | x -7.028 y 1.866 z -2.086 |
| | | | | Port Ant to Stbd Ant Scalar Distance (m) 1.997 | | |

S220 Offsets and Measurements - Summary

| Measurement | IMU to 8160 (MRU to Trans) | Port Ant to 8160 (Nav to Trans) | Waterline to RP* | Port Ant to Stbd Ant | IMU to Port Ant | IMU to Heave |
|-------------|----------------------------|---------------------------------|------------------|-----------------------|-----------------|--------------|
| Coord. Sys. | Caris | Caris | Caris | Caris | Caris | Caris |
| x | 0.493 | -0.304 | n/a | Scaler Distance 1.997 | 0.797 | -11.892 |
| y | 7.665 | 19.557 | n/a | | -11.892 | 0.797 |
| z | 4.520 | 17.588 | 0.014 | | 13.068 | -13.068 |

*Top of IMU is RP (Reference Pt)

Vessel Offsets for S220 8160 are derived from Westlake Survey Report NOAA Fairweather 09-23-03, Fairweather Centerline Survey (NGS) Report March 2009, and measurements by FA personnel.

Derivations

| Coord. Sys. | IMU to 8160 | Port Ant to 8160 |
|---------------------------------|--------------------|---------------------------|
| | Westlake | NGS 2009 |
| IMU easting | 0.000 | Top of IMU x -11.892 |
| Base northing | 0.000 | to Port Ant y 0.797 |
| (ft/m) elevation | 0.000 | (m) z 13.068 |
| 8160 (from IMU Base to sensor) | CARIS | |
| easting | 25.149 | Port x 0.797 |
| (ft) northing | 1.619 | Ant y -11.892 |
| elevation | 14.956 | (m) z -13.068 |
| 8160 (from IMU Base to sensor) | Westlake | |
| easting | 7.665 | (m) easting 7.665 |
| (m) northing | 0.493 | Top of IMU northing 0.493 |
| elevation | 4.559 | to 8160 elevation 4.520 |
| Base of IMU to Top of IMU | CARIS | |
| (m) elevation | -0.168 | (m) x 0.493 |
| Correction based on Ref Surface | | Top of IMU y 7.665 |
| (m) elevation | -0.206 | to 8160 z 4.520 |
| | IMU to 8160 | Port Ant to 8160 |
| Westlake easting | 7.665 | CARIS x -0.304 |
| Top of IMU northing | 0.493 | y 19.557 |
| to 8160 (m) elevation | 4.520 | (m) z 17.588 |
| Coord Sys CARIS | | Coord Sys CARIS |
| x | 0.493 | x |
| y | 7.665 | y |
| z | 4.520 | z |

| Measurement | IMU to Port Ant | |
|-------------|-----------------|--------|
| Coord. Sys. | Caris | Pos/Mv |
| x | 0.797 | 2.868 |
| y | -11.892 | 8.252 |
| z | 13.047 | 4.430 |

| Port Ant to K5K Towpoint | | |
|--------------------------|---------|--------|
| Coord. Sys. | Caris | Pos/Mv |
| x | 0.797 | |
| y | -11.892 | |
| z | 13.047 | |

Derivations

| Coord. Sys. | IMU to K5K Towpoint | |
|-------------|---------------------|--|
| Coord Sys | CARIS | |
| x | 1.866 | |
| y | -42.642 | |
| z | 7.402 | |

| Port Ant to K5K Towpoint | | |
|--------------------------|---------|--|
| Coord Sys | CARIS | |
| x | 1.866 | |
| y | -30.370 | |
| z | 5.645 | |

Description of Offsets for FAIRWEATHER S-220

All Values Shown are in CARIS Coordinates

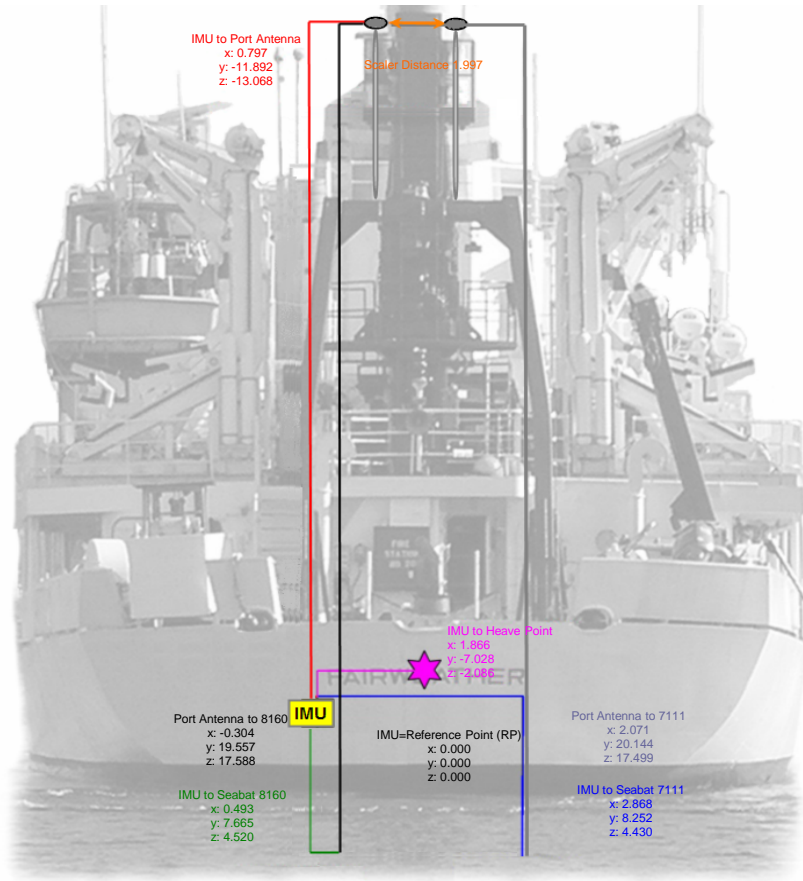
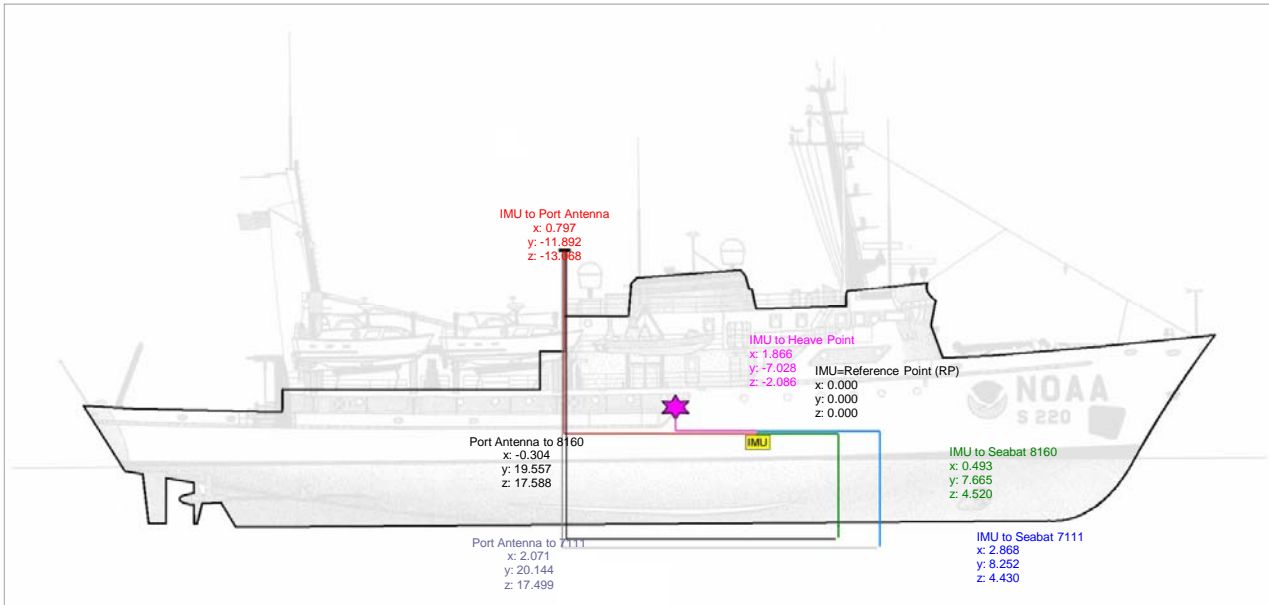

| IMU to 7/8111 (MRU to Trans) | | |
|------------------------------|-------|-------|
| x | y | z |
| 2.868 | 8.252 | 4.430 |

The lever arms between the IMU and phase center of the 7111 transducer are taken from the Westlake report along with the the -0.168 m offset included for the height of the IMU. An additional correction based on 2010 reference surface comparisons of -0.322 is applied.

| IMU to 8160 (MRU to Trans) | | |
|----------------------------|-------|-------|
| x | y | z |
| 0.493 | 7.665 | 4.520 |

The lever arms between the IMU and phase center of the 8160 transducer are taken from the Westlake report with the addition of the -0.168 m offset included for the height of the IMU. An additional correction based on 2010 reference surface comparisons of -0.206 is applied.

| Port Ant to 7/8111 (Nav to Trans) | | |
|-----------------------------------|--------|--------|
| x | y | z |
| 2.071 | 20.144 | 17.499 |

Relative positions obtained from Port Ant to 7/8111 via IMU.

| Port Ant to 8160 (Nav to Trans) | | |
|---------------------------------|--------|--------|
| x | y | z |
| -0.304 | 19.557 | 17.588 |

Relative positions obtained from Port Ant to 7/8111 via IMU.

| Port Ant to Stbd Ant | |
|----------------------|-------|
| Scaler Distance | 1.997 |

Using the NGS 2009 survey values for the antennas, a calculated vector for antenna separation was determined. The distance from Top of Antenna to Phase Center does not affect this calculation and therefore was not included.

| IMU to Port Ant | | |
|-----------------|---------|--------|
| x | y | z |
| 0.797 | -11.892 | 13.068 |

This information comes from a combination of the Westlake, NGS surveys, and measurements by FA personnel. The NGS 2009 survey was to the top of the antenna, that distance (z-value) was measured in 2010 and subtracted to get the xyz of the antenna post. Then the distance (z-value) up to the phase center to the new 2010 antenna was added to obtain the xyz of the phase center of the newly installed (May2010) antenna.

| Waterline to RP* | | |
|------------------|-----|-------|
| x | y | z |
| n/a | n/a | 0.014 |

The height of the IMU above the keel comes from the Westlake survey value of 3.919 m plus the measured value of the top of the IMU to the base plate, to get an IMU height above the keel. The draft (waterline to keel) used for the FAIRWEATHER is based on observations. Ship's Draft spreadsheet. Differencing the value of IMU to keel and waterline to keel gives the waterline to RP distance.

| IMU to Heave | | |
|--------------|--------|--------|
| x | y | z |
| 1.866 | -7.028 | -2.086 |

Key points on the IMU, from the Westlake survey, are its location with respect to the ship's reference frame. It is 4.087 m (3.919 m to base line + 0.168 m for IMU height above base plate) above the keel, 1.866 m port of centerline and 3.547 m forward of frame 52. This information is needed to reference the IMU to the ship's Heave Measurement Location (Heave Point). *

| IMU to Heave | |
|----------------------------------|--|
| From pg 3 of the Westlake Survey | |

SUMMARY

- IMU foundation plate is level to within +/-0.001 feet.
- IMU foundation plate is located 12.856 feet above baseline established at the keel.
- IMU is parallel to ship's centerline to within +/- 0.001 feet.
Location of scribed centerline intersection is 6.122 feet port of ship's centerline.
- IMU foundation plate centerline is located 11.638' feet forward of bulkhead 52.

IMU to Heave

* From the Art Anderson inclination experiment the position of the metacenter was used as the position of the ship's Heave Point. (There may be a better way to determine the Heave Point, but this decision was based upon available information). The metacenter is defined by the center of buoyancy. As a vessel inclines through small angles, the center of buoyancy moves through the arc of a circle whose center is at the metacenter.

Important numbers and information determined from the Art Anderson report are the location of the metacenter and how it is positioned with respect to the vessel. The longitudinal location of the metacenter is defined as 102.42 feet (31.217 m) aft of the forward perpendicular. The height of the metacenter is 20.25 feet (6.172 m) above the keel. There is an assumption of the metacenter being on the centerline of the vessel. Similar values for the RAINIER's metacenter are 32.52 m aft of the forward perpendicular and 5.2 m above the keel. The difference in the height of the metacenter can be attributed to the difference between the FA's and RA's average draft which is 13.12 feet as opposed to approximately 14.5 feet respectively.

Referencing the metacenter (Heave Point, HP) to the IMU information requires information about the frame spacing of the vessel. From the Westlake survey, the IMU is located 3.547 m forward of frame 52. From Inclination document, the HP is 31.217 m aft of the forward perpendicular. From engineering drawings of the ship frame spacing is approximately 21 inches. The calculation for the longitudinal location of the HP with respect to frame zero, the Forward Perpendicular (FP) is as follows:

$$52 \text{ (frame)} * 21 \text{ (inches/frame)} / 12 \text{ (inches/ft)} * .3048 \text{ (m/ft)} - 3.547 \text{ m} = 24.190 \text{ m from frame 0.}$$

$$31.217 \text{ m (HP aft of FP)} - 24.190 \text{ m (IMU aft of FP)} = 7.027 \text{ m (HP aft of IMU)}$$

The calculation for the vertical separation between the IMU and the HP is based on the height of the metacenter being 6.172m and the height of the IMU being 4.087 m above the keel. Differencing yields the metacenter being 2.085 m above the IMU.

The calculation for the athwartship separation is based upon the assumption that the HP is on the centerline and the knowledge that the IMU is 1.866 m to port of the centerline.

Sources

Offset values for the ship were derived from three sources. Three static offset surveys, an inclination experiment, and values measured or approximated by ship's personnel.

On September 23, 2003 an offset survey of the NOAA Ship FAIRWEATHER was conducted by:

Westlake Consultants, Incorporated
15115 SW Sequoia Parkway, Suite 150
Tigard, Oregon 97224
Phone (503) 684-0652

The relocation of the POS M/V antenna forced a partial resurvey in Feb. 2007 by Steven Breidenbach of NGS (values no longer utilized).

While in drydock, another NGS (Centerline) survey was conducted March, 2009.

These values relate the physical positions of one sensor to the next with the base plate of the IMU being the point of origin. All dimensions in the document are given in feet and decimal feet.

On July 16, 2004 an inclination experiment was conducted at MOC-P by:

Art Anderson Associates
202 Pacific Avenue
Bremerton, WA 98337-1932

Calculations

The values for the required lever arms are listed in the S220_Offsets and Measurements spreadsheet. The reference point and the IMU are identical. Difference in documentation between Westlake and FA calculations are based off of measuring up from the IMU base (Westlake's origin) and the top of the IMU. The top center of the IMU for the POS/MV is the defined origin for the POS/MV and the origin that is being used on all FAIRWEATHER vessels. The distance from the base plate to the top of the IMU is 0.168 m, a value measured by ship's complement. Conversion factor from feet to meters is 0.3048 m/ft.

As a requirement for the TPU, the standard deviation for each position is 3 mm. This value is based upon a conversation with Elaine McDonald of Westlake and is followed up by an Email documenting that fact. The email is located at the end of this document.

Fairweather Draft - 2010

Immediately prior to the FA field season, the draft measurements were taken prior to fueling when the takes were very empty after shipyard (Empty) . And again after fueling and once the engineers had transferred the fuel in a satisfactory manner (Full). The waterline at the IMU was then calculated based on a linear interpolation.

| 2010 | April | | Fwd | | Aft | | slope | IMU Depth (ft) | IMU Depth (m) | Min | Max |
|------|------------------------------|------|-------|-----|-------|---------|-------|----------------|---------------|-------|-----|
| | | x1 | y1 | x2 | y2 | | | | | | |
| | Empty - Port | 5.25 | 12.67 | 189 | 13.83 | 0.00635 | 13.14 | 4.004 | 12.67 | 14.83 | |
| | Empty - Stbd | 5.25 | 13.00 | 189 | 14.17 | 0.00635 | 13.47 | 4.106 | | | |
| | Full - Port | 5.25 | 12.83 | 189 | 14.83 | 0.01088 | 13.64 | 4.157 | | | |
| | Full - Stbd | 5.25 | 12.75 | 189 | 14.75 | 0.01088 | 13.56 | 4.132 | | | |
| | Description (ie empty, full) | 5.25 | | 189 | | 0.00000 | 0.00 | 0.000 | | | |

| | | | | | | | |
|---------|---------------|-------|-------------------|-------|-------|-------|--|
| The IMU | x-value (ft): | 79.36 | Draft at IMU (ft) | 13.45 | 4.100 | AVG | Value Used in Offsets |
| | x-value (m): | 24.19 | | 0.220 | 0.067 | STDEV | Value used for Waterline Loading Uncertainty |

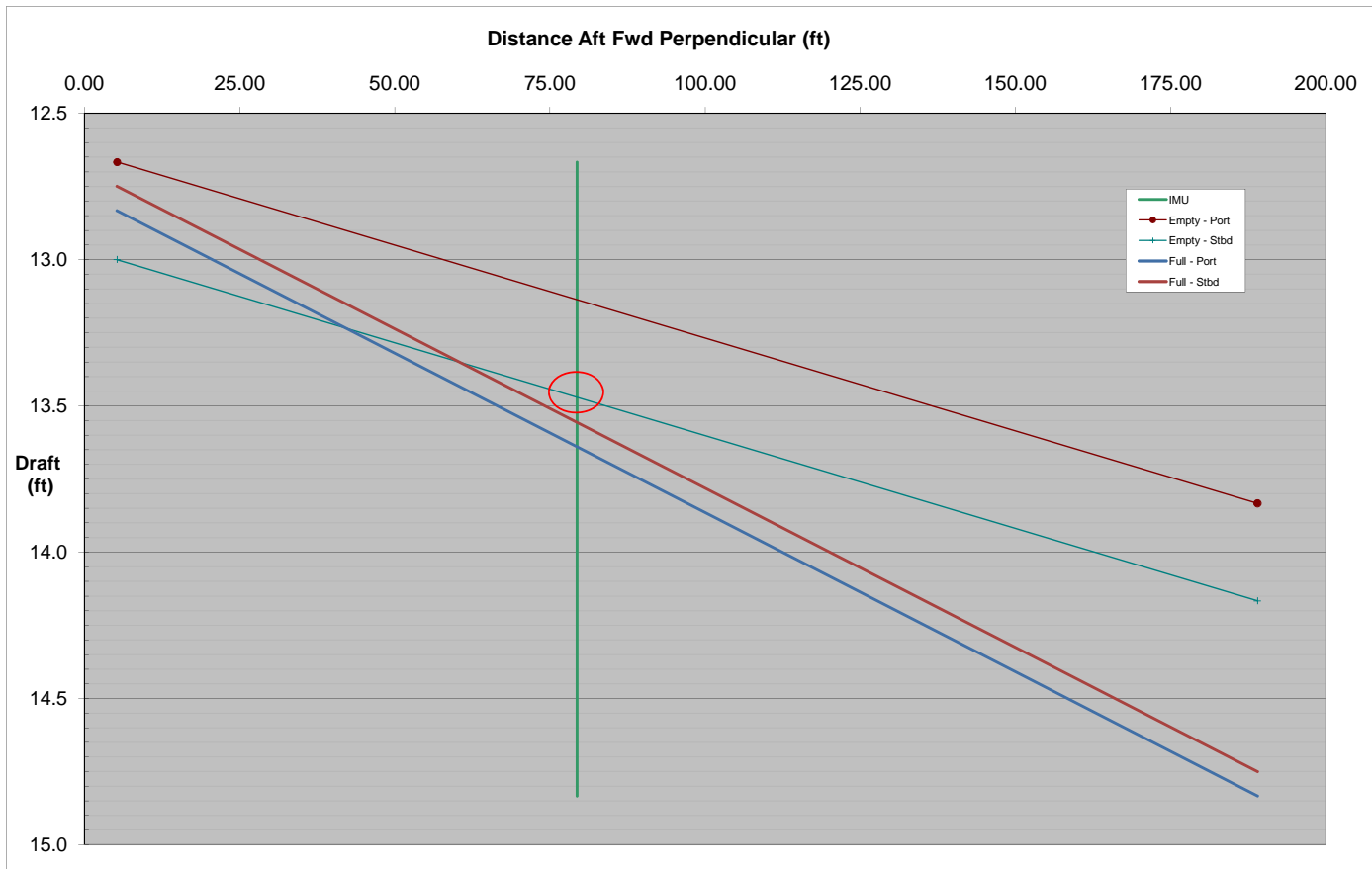

US DEPARTMENT OF COMMERCE
NATIONAL OCEANIC & ATMOSPHERIC ADMINISTRATION
NATIONAL OCEAN SERVICE
NATIONAL GEODETIC SURVEY
GEODETIC SERVICES DIVISION
INSTRUMENTATION & METHODOLOGIES BRANCH

**NOAA SHIP FAIRWEATHER
POS MV COMPONENTS SPATIAL RELATIONSHIP SURVEY
FIELD REPORT**

Kendall Fancher
March , 2009

PRIMARY CONTACTS

Glen Rice

NOAA 757-615-6465

NOAA SHIP FAIRWEATHER POS MV COMPONENTS SPATIAL RELATIONSHIP SURVEY

PURPOSE

The primary purpose of the survey was to precisely determine the spatial relationship of various components of a POS MV navigation system aboard the NOAA ship FAIRWEATHER. Additionally, various reference points (bench marks) were re-established onboard the vessel to aid in future spatial surveys aboard the boat.

PROJECT DETAILS

This survey was conducted while the ship was in dry dock at the Lake Union dry dock in Seattle, WA. The weather conditions over the two days required to conduct this survey were windy, cool, with intermittent rain.

INSTRUMENTATION

The Leica TC2003 total station was used to make all measurements.

Technical Data:

| | |
|----------------------|--------------|
| Standard Deviation | |
| Horizontal angle | 0.5 seconds |
| Vertical angle | 0.5 seconds |
| Distance measurement | 0.2mm + 2ppm |

A Leica precision prism was used as a sighting target. This prism was configured to have a zero mm offset.

PERSONNEL

| | |
|-----------------|---|
| Kendall Fancher | NOAA/NOS/NGS/GSD/I&M BRANCH (540) 373-1243 |
| Dennis Lokken | NOAA/NOS/NGS/GSD/I&M BRANCH (540) 373-1243 |

NOAA SHIP FAIRWEATHER POS MV COMPONENTS SPATIAL RELATIONSHIP SURVEY

DEFINITION OF THE REFERENCE FRAME

To conduct this survey a local coordinate reference frame was established where the Northing (Y) axis runs along the centerline of the ship and is positive from the IMU towards the bow of the ship. The Easting (X) axis is perpendicular to the centerline of the ship and is positive from the IMU towards the right, when looking at the ship from the stern. The Up (Z) axis is positive in an upward direction from the IMU.

SURVEY METHODOLOGY

02/15/2009

Coordinates of 100.000N, 100.000E, and 100.000U were assumed for temporary control point 1. A distance and height difference were measured between temporary control points 1 and 3. These values were used to determine the coordinates at temporary control point 3. Temporary control points 1 and 3 were located along the top deck and on the north side of the dry dock vessel.

Temporary control point 1 was occupied and temporary control point 3 was observed for a backsight. After initialization, temporary control points 2 and 4 (located on the top deck of the dry dock vessel), H1 (located on the bottom deck of the dry dock vessel), and BOW BM were observed in both direct and reverse.

Temporary control point 2 was occupied and temporary control point 3 was observed for a backsight. After initialization, temporary control point W1 (located on the top deck of the dry dock vessel) and D1 (located inside the ship on the D deck along the port side) were observed in both direct and reverse. Temporary control point 1 was also observed and yielded an inverse check of 0.001m horizontally and 0.001m vertically.

Temporary control point 4 was occupied and control point 1 was observed for a backsight. After initialization, temporary control point 5 (located on the south side and on the top deck of the dry dock vessel) was observed in both direct and reverse.

Temporary control point 5 was occupied and control point 4 was observed for a backsight. After initialization, temporary control point D2 (located inside the ship on the D deck along the starboard side) was observed in both direct and reverse.

Temporary control point H1 was occupied and control point 1 was observed for a backsight. After initialization, temporary control point H2 (located on the bottom deck of the dry dock vessel), and USBL BM were observed in both direct and reverse.

Temporary control point H2 was occupied and temporary control point H1 was observed for a backsight. After initialization, 8111 BM and 8160 BM were observed in both direct and reverse. Temporary control point W1 was also observed and yielded an inverse check of 0.019m horizontally and 0.033m vertically.

Temporary control point D1 was occupied and temporary control point D2 was observed for a backsight. After initialization, temporary control point D3 (located in the doorway leading to the mess hall on the D deck) was observed in both direct and reverse.

Temporary control point D3 was occupied and temporary control point D1 was observed for a backsight. After initialization, temporary control point C1 (located on the C deck near the IMU) was observed in both direct and reverse. Temporary control point D2 was also observed and yielded an inverse check of 0.026m horizontally and 0.0001m vertically.

Temporary control point C1 was occupied and temporary control point D3 was observed for a backsight. After initialization, IMU, IMU BOW PORT CORNER, IMU BOW STAR CORNER, IMU STERN STAR CORNER, and IMU STERN PORT CORNER were observed in both direct and reverse.

02/16/2009

Temporary control point 4 was occupied and control point 1 was observed for a backsight. After initialization, temporary control point 6 (located on the south side and on the top deck of the dry dock vessel) and BOW BM were observed in both direct and reverse. Temporary control point D2 was also observed and yielded an inverse check of 0.0004m horizontally and 0.083m vertically.

Temporary control point 6 was occupied and temporary control point 4 was observed for a backsight. After initialization, TRANSOM PIVOT POINT PORT, STERN BM, POS GPS ANT RAIL BM, POS IMU ANT DECK BM, POS GPS ANT STARBOARD, and POS GPS ANT PORT were observed in both direct and reverse.

Temporary control point 3 was occupied and temporary control point 1 was observed for a backsight. After initialization, TRANSOM PIVOT POINT STARBOARD, STERN BM, POS GPS ANT STARBOARD, and POS GPS ANT PORT were observed in both direct and reverse. Temporary control point 6 was also observed and yielded an inverse check of 0.0006m horizontally and 0.001m vertically.

The reference frame was rotated using STERN BM as the point of rotation. A zero degree azimuth was used during the rotation from STERN BM to BOW BM. The reference frame was then translated to relocate the origin of the reference frame to the IMU.

**NOAA SHIP FAIRWEATHER
POS MV COMPONENTS SPATIAL RELATIONSHIP SURVEY**

INVERSE RESULTS

Inverses were computed between the determined positions of those ship benchmarks and sensor points which were determined from two separate locations. The results of these inverses are:

| ID | Horizontal Dist.(m) | Elevation Diff(m) |
|-----------------------|----------------------------|--------------------------|
| BOW BM | 0.0150 | 0.0240 |
| STERN BM | 0.0060 | 0.0010 |
| POS GPS ANT STARBOARD | 0.0100 | 0.0001 |
| POS GPS ANT PORT | 0.0100 | 0.0000 |

DISCUSSION

The Fairweather was in dry dock during this survey, however, the dry dock vessel was still subject to movement due to wave action. Conducting a survey such as this while the ship is moving requires that the automatic compensators in the survey instrument be turned off. The survey is therefore conducted with all survey instrumentation set up relative to the mean movement of the related level vials. While every effort was made to make the most precise measurements possible, some additional error accumulation cannot be avoided under these type observing conditions.

The POS GPS antenna coordinates were determined to the top center of the antennas. The Z value should be corrected to the Antenna Reference Point (ARP). In order to apply this correction, the mechanical height of the antenna should be determined and subtracted from the Z value determined during this survey for both of the POS GPS antennas.

**NOAA SHIP FAIRWEATHER
POS MV COMPONENTS SPATIAL RELATIONSHIP SURVEY**

Coordinate Listing using IMU as the Reference Frame Origin

| ID | X(NORTHING)m | Y(EASTING)m | Z(UP)m |
|-------------------------------|---------------------|--------------------|---------------|
| IMU CENTER | 0.000 | 0.000 | 0.000 |
| IMU STERN PORT CORNER | -0.071 | -0.089 | -0.001 |
| IMU BOW PORT CORNER | 0.070 | -0.086 | -0.001 |
| IMU BOW STARBOARD CORNER | 0.069 | 0.087 | 0.000 |
| IMU STERN STARBOARD CORNER | -0.073 | 0.086 | 0.000 |
| BOW BM | 28.378 | 1.805 | 7.796 |
| STERN BM | -40.306 | 1.805 | 2.255 |
| USBL BM | -28.354 | 1.738 | -4.204 |
| 8160 BM | 8.407 | 0.395 | -4.400 |
| 8111 BM | 8.532 | 3.002 | -4.666 |
| POS GPS ANT RAIL BM | -12.011 | 1.785 | 10.381 |
| POS IMU ANT DECK BM | -11.790 | 1.780 | 9.305 |
| POS GPS ANT STARBOARD | -11.886 | 2.794 | 13.051 |
| POS GPS ANT PORT | -11.892 | 0.797 | 13.047 |
| TRANSOM PIVOT POINT STARBOARD | -39.727 | 3.366 | 2.385 |
| TRANSOM PIVOT POINT PORT | -39.722 | 0.240 | 2.345 |

**NOAA SHIP FAIRWEATHER
POS MV COMPONENTS SPATIAL RELATIONSHIP SURVEY**



IMU Reference Points

**NOAA SHIP FAIRWEATHER
POS MV COMPONENTS SPATIAL RELATIONSHIP SURVEY**



POS GPS ANTENNAS

**NOAA SHIP FAIRWEATHER
POS MV COMPONENTS SPATIAL RELATIONSHIP SURVEY**



BOW CENTERLINE REFERENCE POINT

**NOAA SHIP FAIRWEATHER
POS MV COMPONENTS SPATIAL RELATIONSHIP SURVEY**



CENTERLINE REFERENCE POINT ON G DECK

**NOAA SHIP FAIRWEATHER
POS MV COMPONENTS SPATIAL RELATIONSHIP SURVEY**



CENTERLINE REFERENCE POINT ON RAIL AT G DECK

**NOAA SHIP FAIRWEATHER
POS MV COMPONENTS SPATIAL RELATIONSHIP SURVEY**



CENTERLINE STERN REFERENCE POINT

**NOAA SHIP FAIRWEATHER
POS MV COMPONENTS SPATIAL RELATIONSHIP SURVEY**



TRANSOM REFERENCE POINT ON PORT SIDE



TRANSOM REFERENCE POINT ON STARBOARD SIDE

**NOAA SHIP FAIRWEATHER
POS MV COMPONENTS SPATIAL RELATIONSHIP SURVEY**



8111 REFERENCE POINT



**NOAA SHIP FAIRWEATHER
POS MV COMPONENTS SPATIAL RELATIONSHIP SURVEY**



8160 REFERENCE POINT



**NOAA SHIP FAIRWEATHER
POS MV COMPONENTS SPATIAL RELATIONSHIP SURVEY**



USBL REFERENCE POINT



STABILITY TEST:

NOAA Ship FAIRWEATHER (16 Jul 2004)

SHIP AT TIME OF STABILITY TEST--CONDITION 0

| | | FROM HYDROSTATIC CURVES | FROM INDEPENDENT CALCULATION |
|---|---|-------------------------|------------------------------|
| Corrected displacement | | _____ tons | 1638.79 tons |
| Mean virtual metacentric height obtained from plot of inclining moments versus tangents of angles of heel | $\frac{\text{moment}}{\text{displacement} \times \text{tangent}} = 5987.252 / 1638.790$ | _____ feet | 3.65 feet |
| Correction for free surface | $= 374.0 / 1638.790$ | _____ feet | 0.23 feet |
| Mean metacentric height G.M. = | | _____ feet | 3.88 feet |
| Transverse metacenter above base line corresponding to draft at LCF (corrected for hog or sag) | | _____ feet | |
| Transverse metacenter above base line corrected for trim, and hog or sag | | _____ feet | |
| C.G. above base line | | _____ feet | 16.37 feet (from figure) |
| | | | 16.36 feet (from GHS) |
| Longitudinal metacenter above C.G. | | _____ feet | |
| Moment to alter trim 1 foot, (Long GM x Δ) / L | | _____ ft-tons | |
| Trim by stern | | _____ feet | |
| Trimming lever = (Trim x moment to trim) / displacement | | _____ feet | |
| Longitudinal center of buoyancy (LCB) from origin | | _____ feet | |
| C.G. from origin | | _____ feet | 102.44 feet (from figure) |
| | | | 102.42 feet (from GHS) |

Period of complete roll _____ seconds

Apparent radius of gyration of vessel $\alpha = \frac{T \cdot GM}{1.108}$ _____ feet

Rolling constant $C = \frac{T \cdot GM}{B}$ _____

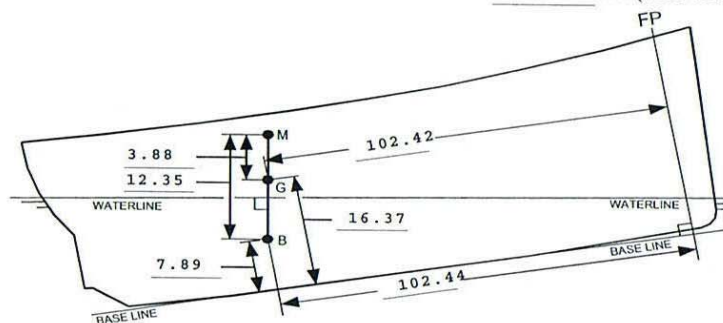

7/29/2004 8:05 AM

Definitions and Basis for Dimensions/Locations

Northings

Northings (Port - Starboard) are with reference to the IMU Foundation Plate centerline scribe.

Positive values are starboard of the IMU.

Negative values are port of the IMU.

Calculated values are in italics.

Eastings

Eastings (Stern to Bow) are with reference to the IMU Foundation Plate centerline scribe.

Positive values are forward of the IMU.

Negative values are aft of the IMU.

Calculated values are in italics.

Elevations

Elevations are with reference to the IMU Foundation Plate centerline scribe = 0 elevation.

Positive values are below the IMU (toward the keel).

Negative values are toward the topside.

Dimensions

All dimensions are in feet and decimal feet. All dimensions provided are "offsets" to IMU centerline.

Ship's Centerline Data

At project initiation, control was established to define the ship's centerline as a plane running from a point on the centerline of the keel at the stern through a point on the centerline of the keel near the bow, to a point on the bow splitting the bow chock.

IMU Referenced Data - Procedure

All data was originally referenced to the ship's geometry.

Following location of the IMU, data was transformed to the IMU as point of origin for

Northings, Eastings, and Elevation. All dimensions provided with reference to the IMU are "offsets."

Ship's Centerline - Control Measurements

(Prior to location of IMU and referencing of data to IMU as point of origin (0,0,0))

Defined by measurements at the keel centerline

| | longitude | transverse | elevation |
|--------------------------------------|-----------|------------|-----------|
| near the bow | 1190.674 | 1000.000 | 135.8672 |
| at the stern (point of origin) | 1000.000 | 1000.000 | 100.0000 |
| along the keel (approx 180' forward) | 1180.121 | 1000.000 | 116.6810 |

Ship's Baseline

Defined by measurements on the keel

| | longitude | transverse | elevation |
|-----------------------------------|-----------|------------|-----------|
| at the stern (point of origin) | 1000.000 | 1000.000 | 100.0000 |
| and approx. 129' forward of stern | 1129.120 | 999.985 | 100.0022 |

IMU Foundation Plate

| | EASTING | NORTHING | ELEVATION |
|---|----------------|-----------------|------------------|
| Horizontal alignment per scribed lines on IMU foundation plate | | 0.001 0.000 | |
| Scribed lines - intersection/centerline of IMU plate | 0.000 | 0.000 | 0.000 |
| Elevation checks near four corners of IMU Foundation plate * | | | 0.001 |
| <i>* elevation check adjusted for target that created 10 mm offset =.03281 feet</i> | | | -0.001 |
| | | | 0.000 |
| | | | -0.001 |

SUMMARY

- IMU foundation plate is level to within +/-0.001 feet.
- IMU foundation plate is located 12.856 feet above baseline established at the keel.
- IMU is parallel to ship's centerline to within +/- 0.001 feet.
Location of scribed centerline intersection is 6.122 feet port of ship's centerline.
- IMU foundation plate centerline is located 11.638' feet forward of bulkhead 52.

Granite Block

| | <i>EASTING</i> | <i>NORTHING</i> | <i>ELEVATION</i> | |
|--|----------------|-----------------|--------------------------------------|--|
| Horizontal alignment per scribed lines | | 1.584 1.583 | | |
| Scribed lines - intersection/centerline of granite block | -0.003 | 1.583 | | |
| Elevation checks near four corners of granite block <i>* elevation check adjusted for target that created 10 mm offset = 0.03281 feet</i> | | | -0.217 -0.217 -0.216 -0.215 | Deviation from level -0.001 -0.001 0.001 0.001 |

SUMMARY

- Granite block is level to within +/-0.001 foot of average elevation = -0.21632 feet
- Granite block is parallel to ship's centerline to within 0.001 foot
Location is 4.54 feet to port of ship's centerline and 1.583 feet starboard of IMU.
- Granite block is aligned with IMU to within 0.003 feet longitudinally.

Array Acoustical Centers - Referenced to IMU

| | <i>EASTING</i> | <i>NORTHING</i> | <i>ELEVATION</i> |
|---------------------------|----------------|-----------------|------------------|
| PORT ARRAY (81-60) | 25.149 | 1.619 | 14.956 |

Explanation of Calculations

Acoustic center is defined as the center of the transmitter array with the elevation = 83 mm below mounting face of array.

Easting

Center of array is defined by the foundation plate bolt centerlines (1/2 distance between bolts)

- 27.008 Forward edge of foundation as measured
- 0.104 Forward edge of foundation to centerline of forward bolt hole
- 1.755 Distance from bolt hole centerline to center of array

25.149 feet forward of IMU

Northing

Center of array is defined as the mid-point between the bolt holes on the foundation.

- 1.369 Port edge of foundation as measured
- + 0.078 Port edge of foundation to centerline of bolt hole - per Cascade General
- + 0.172 Distance from bolt hole centerline to array center

1.619 feet starboard of IMU

Elevation

Per Reson drawing 2148M011_001 the elevation is 83 mm below array mounting surface

- 14.679 Array foundation elevation as measured.
- 0.005 Isolation "shim" added between foundation and array
- 0.272 83 mm below array mounting surface to acoustical center

14.956 feet below IMU

Array Acoustical Centers - Referenced to IMU

| | <i>EASTING</i> | <i>NORTHING</i> | <i>ELEVATION</i> |
|--------------------------------|----------------|-----------------|------------------|
| STARBOARD ARRAY (81-11) | 27.072 | 9.41 | 15.042 |

Explanation of Calculations

Acoustic center is defined as midpoint of the transmitter array in the longitudinal and transverse axes. The elevation is defined as the center of the receiving array.

Easting

Center of array is defined as 0.235' aft of the forward bolt centerlines on transmitter array foundation

- 28.563 Forward edge of foundation fixture plate as measured (receiving plate forward edge)
- 27.349 Forward edge of transmitter array foundation as calculated
- 0.042 Forward edge of foundation to centerline of forward bolt hole - per design
- 0.235 Distance from bolt hole centerline to center of array - per design

27.072 feet forward of IMU

Northing

Center of array is defined as the mid-point between the bolt holes on the transmitter array foundation.

- 9.410 Centerline of array foundation as measured on scribe - aft section of fixture plate

9.410 feet starboard of IMU

Elevation

Elevation is 0.401 feet above receiver array mounting surface

- 16.085 Mounting foundation fixture plate as measured.
- 15.447 Receiver foundation elevation - as calculated
- + 0.005 Isolation "shim" added between foundation and array
- 0.410 Design distance from mounting surface of array to acoustic center

15.042 feet below IMU

Longitudinal Array Foundation - Port Side

| | EASTING | NORTHING | ELEVATION | |
|---|----------------|-----------------|------------------|--------------------------------|
| Horizontal alignment <i>measured</i> at port edge of array foundation | | 1.369 | | |
| | | 1.369 | | |
| Forward edge of array foundation - <i>measured</i> | 27.008 | | | |
| Horizontal alignment - <i>calculated</i> to array centerline | | 1.619 | | |
| <i>Foundation edge is 0.25 feet port of array centerline</i> | | 1.619 | | |
| Elevation checks near four corners of array foundation | | | | deviation from level (average) |
| | | | 14.680 | 0.001 |
| | | | 14.681 | 0.002 |
| | | | 14.678 | -0.001 |
| | | | 14.677 | -0.002 |

SUMMARY

- Port longitudinal array foundation average elevation is 14.679 feet.
Variation in elevation is +0.002 to -0.002 feet.
- Port longitudinal array foundation is parallel to ship's centerline and 1.369 feet starboard of IMU.
Calculated array centerline is 1.619 feet starboard of IMU

Longitudinal Array Foundation - Starboard Side

| | EASTING | NORTHING | ELEVATION | |
|---|---------------------------|----------------|--------------------------------------|---|
| Horizontal alignment <i>measured</i> on fixture plate scribe - <i>Design location is 3.292 feet starboard of ship centerline</i> | | 9.410 9.406 | | <i>deviation from parallel</i> 0.002 -0.002 |
| Forward edge of array foundation fixture plate - <i>measured</i> | 28.563 | | | |
| Elevation checks near four corners of array foundation "fixture plate" | | | 16.085 16.085 16.084 16.085 | <i>deviation from average</i> 0.000 0.000 0.000 0.000 |
| <i>Calculated locations of longitudinal and transverse array foundations</i> | | | | |
| Forward edge | | | | |
| Receiver (transverse) | 28.563 | | | |
| Transmitter (longitudinal) | | 27.349 | | |
| | <i>difference = 1.214</i> | | | |
| NOTE: <i>On Transmitter array foundation - from forward edge to center of forward holes = 0.042'</i> <i>On Receiver array foundation distance from forward edge to center of forward holes = 0.076'</i> | | | | |
| <i>Calculated elevation of longitudinal and transverse array foundations</i> | | | | |
| Receiver/Transverse Foundation | | | 15.446 | |
| Transmitter/Longitudinal Foundation | | | 15.709 | |
| | <i>difference = 0.263</i> | | | |

SUMMARY

- Starboard longitudinal array foundation (measured at fixture plate) average elevation is 16.085 feet. Deviation from level (average elevation) is less than 0.001 feet.
- Starboard longitudinal array foundation averages 9.408 feet starboard of IMU. Variation from parallel is from -0.002 feet to +0.002 feet from average.
- Starboard longitudinal array foundation forward edge is 28.563 feet forward of IMU.

Transverse Array Foundation - Port Side

| | EASTING | NORTHING | ELEVATION | |
|--|---------|----------|-----------|----------------------|
| Forward Edge - Transverse array foundation - <i>measured</i> | 28.343 | | | |
| | 28.338 | | | |
| Port edge - Transverse array - <i>measured</i> | | -0.181 | | |
| Centerline of array - <i>calculated</i> | | | | |
| Foundation forward edge minus 0.25 feet to array centerline | 28.093 | | | |
| | 28.088 | | | |
| Port edge of foundation plus 1.806 feet to calculated array centerline | | 1.624 | | |
| Elevation checks near four corners of array foundation | | | 14.679 | deviation from level |
| | | | 14.675 | 0.002 |
| 0.861 feet below baseline with 0.965 foot offset = 98.180 feet average elevation | | | 14.675 | -0.001 |
| | | | 14.677 | -0.001 |
| | | | | 0.001 |

SUMMARY

- Transverse array foundation average measured elevation is 14.677 feet below IMU (0.006 feet above design location).
Deviation from level (average elevation) is 0.003 to -0.001 feet
- Transverse array foundation centerline (calculated) averages 28.090 feet forward of IMU.
Variation from parallel to ship's centerline is from -0.003 to 0.003 feet (from average).
- Transverse array centerline is calculated to be 1.624 feet starboard of IMU.

Transverse Array Foundation - Starboard Side

NOTE: Direct Measurements were not taken to the transverse array because a single "fixture plate" covered both transmitter and receiver foundations. The data provided here is primarily "calculated".

| | EASTING | NORTHING | ELEVATION |
|---|----------------|-----------------|------------------|
| Forward edge - as measured on fixture plate | | | |
| Receiver - (transverse) | 28.563 | | |
| as measured | | | |
| Transmitter (longitudinal) | 27.349 | | |
| <i>difference = 1.214</i> | | | |
| NOTE: On Transmitter array foundation - from forward edge to center of forward holes = 0.042' On Receiver array foundation distance from forward edge to center of forward holes = 0.076' | | | |
| Horizontal Alignment | | 9.406 | |
| centerline scribe on fixture plate | | | |
| as measured - forward portion of plate | | | |
| (near receiver array) | | | |
| <i>Average of measurements on fixture plate</i> | | 9.408 | |
| <i>Elevation of longitudinal and transverse array foundations</i> | | | |
| <i>Receiver/Transducer Transverse Foundation</i> | | | 15.446 |
| <i>Transmitter/Longitudinal Foundation</i> | | | 15.709 |
| <i>difference = 0.263</i> | | | |

Based on measured elevations averaging 16.085 feet across fixture plate

SUMMARY

- Transverse array foundation is calculated to be 15.446 feet below IMU - calculated from measured elevation of 16.085 feet. Deviation in elevation measurements across the array fixture plate is less than 0.001 feet
- Transverse array foundation forward edge (measured) is 28.563 feet forward of IMU.
- Transverse array centerline is measured to be 9.406 feet starboard of IMU.

Variation from parallel of the fixture plate across entire starboard array is ± 0.002 feet (from average).

Antennae

| | <i>EASTING</i> | <i>NORTHING</i> | <i>ELEVATION</i> |
|--|----------------|-----------------|------------------|
| Stbd POS MV Antenna -Location | -35.866 | 12.925 | -38.209 |
| Port POS MV Antenna - Location | -35.739 | -0.409 | -38.283 |
| Foundation Plate Stack Antenna Alignment | | 7.677 | |
| Foundation Plate Stack Antenna Alignment | | 7.677 | |
| Port GYRO Foundation Plate Alignment | | 2.411 | |
| Port GYRO Foundation Plate Alignment | | 2.411 | |
| Stbd GYRO Foundation Plate Alignment | | 3.866 | |
| Stbd GYRO Foundation Plate Alignment | | 3.867 | |

SUMMARY

- Foundation plate stack antenna alignment is parallel to ship's centerline.
- Port GYRO Foundation Plate is aligned parallel to ship's centerline.
- Starboard GYRO Foundation Plate is aligned parallel to ship's centerline.

FAIRWEATHER

Multibeam Echosounder Calibration

S220 7111

Vessel

| | | |
|-----------|-----|-----------------------|
| 5/24/2010 | 144 | Revillagigedo Channel |
| Date | Dn | Local Area |

| |
|-----------------------------|
| Campbell |
| Calibrating Hydrographer(s) |

| | | |
|-------------|----------------------|--|
| Reson 7111 | S220 | TPU installed Oct 2009, Sonar installed Mar 2009 |
| MBES System | MBES System Location | Date of most recent EED/Factory Check |

| | |
|---------------------|-------------------------------|
| Unknown | S/N 2009003 |
| Sonar Serial Number | Processing Unit Serial Number |

| | |
|------------------------------|---|
| Hull Mounted | 5/2/2010 |
| Sonar Mounting Configuration | Date of current offset measurement/verification |

| | |
|-----------------------------------|--|
| POS/MV v.4 | 5/4/2010 |
| Description of Positioning System | Date of most recent positioning system calibration |

Acquisition Log

| | | | |
|-----------|-----|-----------------------|------------------------------------|
| 5/24/2010 | 144 | Revillagigedo Channel | grey, rain, light breeze, low chop |
| Date | Dn | Local Area | Wx |

| | |
|-------------|-------------------------|
| Bottom Type | Approximate Water Depth |
|-------------|-------------------------|

| |
|--------------------|
| Campbell, Loy |
| Personnel on board |

| |
|---|
| Pos file logged to Ketchikan_Patch GNSS folder. |
| Comments |

| |
|--------------------|
| 2010-144-S220 |
| TrueHeave filename |

| | | | | | |
|---------------------|----------|-----|-----|-------|------------|
| BOT_0001 | | | | | |
| SV Cast #1 filename | UTC Time | Lat | Lon | Depth | Ext. Depth |

| | | | | | |
|---------------------|----------|-----|-----|-------|------------|
| | | | | | |
| SV Cast #2 filename | UTC Time | Lat | Lon | Depth | Ext. Depth |

Processing Log

5/24/2010 | 144 | Campbell
 Date Dn Personnel

- Data converted --> HDCS_Data in CARIS
- TrueHeave applied True heave would not apply, fixed or otherwise.
- SVP applied 2010_Patch_Dn144
- Tide applied Predicted
- Zone file O193FA2010CORP_Rev2
- Lines merged
- Data cleaned to remove gross fliers

Compute correctors in this order

1. Precise Timing 2. Pitch bias 3. Heading bias 4. Roll bias

Do not enter/apply correctors until all evaluations are complete and analyzed.

PATCH TEST RESULTS/CORRECTORS

| Evaluators | Latency (sec) | Pitch (deg) | Roll (deg) | Yaw (deg) |
|---------------------------|---------------|-------------|------------|-----------|
| Campbell | 0.00 | -0.50 | 0.08 | -0.70 |
| Froelich | 0.00 | -0.80 | 0.08 | 0.08 |
| Welton | 0.00 | -0.70 | 0.08 | 0.00 |
| | | | | |
| | | | | |
| | | | | |
| | | | | |
| | | | | |
| | | | | |
| | | | | |
| Averages | 0.00 | -0.67 | 0.08 | -0.21 |
| Standard Deviation | 0.00 | 0.15 | 0.00 | 0.06 |
| FINAL VALUES | 0.00 | -0.67 | 0.08 | 0.04 |

Final Values based on All three reviewers with the exception of Campbell's yaw

Resulting HVF File Name FA_S220_Rsn7111_301bms_2010.hvf

MRU Align StdDev gyro 0.06 Value from standard deviation of Heading offset values
 MRU Align StdDev Roll/Pitch 0.08 Value from averaged standard deviations of pitch and roll offset values

NARRATIVE

Entered on Dn 122 in hvf.

- HVF Hydrographic Vessel File created or updated with current offsets

Name: CST Morgan Date: 7/18/10

FAIRWEATHER

Multibeam Echosounder Calibration

S220 7111

Vessel

7/14/2010 | 195 |
Date Dn Local Area

Weston, Renoud, Mike Keeler
Calibrating Hydrographer(s)

Reson 7111 | S220 | TPU installed Oct 2009, Sonar installed Mar 2009
MBES System MBES System Location Date of most recent EED/Factory Check

Unknown | S/N 2009003
Sonar Serial Number Processing Unit Serial Number

Hull Mounted | 5/2/2010
Sonar Mounting Configuration Date of current offset measurement/verification

POS/MV v.4 | 5/4/2010
Description of Positioning System Date of most recent positioning system calibration

Acquisition Log

7/14/2010 | 195 | Dutch Harbor | Overcast
Date Dn Local Area Wx

| 30m
Bottom Type Approximate Water Depth

FA Crew
Personnel on board

Comments

2010_195_S220.000
TrueHeave filename

BOT_0001 | | | | | |
SV Cast #1 filename UTC Time Lat Lon Depth Ext. Depth

| | | | | |
SV Cast #2 filename UTC Time Lat Lon Depth Ext. Depth

Processing Log

Date _____ Dn _____ Personnel _____ Renoud _____

Data converted --> HDCS_Data in CARIS

TrueHeave applied 2010_195_S220.000

SVP applied Previous in time

Tide applied Zero_Tides

Zone file _____

Lines merged

Data cleaned to remove gross fliers

Compute correctors in this order

1. Precise Timing 2. Pitch bias 3. Heading bias 4. Roll bias

Do not enter/apply correctors until all evaluations are complete and analyzed.

PATCH TEST RESULTS/CORRECTORS

| Evaluators | Latency (sec) | Pitch (deg) | Roll (deg) | Yaw (deg) |
|---------------------------|---------------|----------------|------------|-----------|
| CST Morgan | _____ | _____ | -0.10 | _____ |
| SST Beduhn | _____ | _____ | -0.12 | _____ |
| LT Welton | _____ | _____ | -0.10 | _____ |
| SST Renoud | _____ | _____ | -0.12 | _____ |
| _____ | _____ | _____ | _____ | _____ |
| _____ | _____ | _____ | _____ | _____ |
| _____ | _____ | _____ | _____ | _____ |
| _____ | _____ | _____ | _____ | _____ |
| Averages | #DIV/0! | #DIV/0! | -0.11 | #DIV/0! |
| Standard Deviation | #DIV/0! | 0.15 *from 144 | 0.01 | #DIV/0! |
| FINAL VALUES | _____ | _____ | _____ | _____ |

Final Values based on Roll only, based on averages

Resulting HVF File Name FA_S220_Rsn7111_301bms_2010.hvf

MRU Align StdDev gyro #DIV/0! Value from standard deviation of Heading offset values
MRU Align StdDev Roll/Pitch 0.08 Value from averaged standard deviations of pitch and roll offset values

NARRATIVE

Roll value adjusted after 7111 testing lines run in Dutch Harbor.

Value to be used instead of Dn 144 Roll value. MRU values remain as for listed in Dn144, roll/pitch is same as shown above.

HVF Hydrographic Vessel File created or updated with current offsets

Name: CST Morgan

Date: 7/18/10

FAIRWEATHER

Multibeam Echosounder Calibration

S220 8160

Vessel

5/8/2010 | 128 | Revillagigedo Channel
Date Dn Local Area

Campbell, Moehl
Calibrating Hydrographer(s)

Reson 8160 | Fairweather-S220 | 2004
MBES System MBES System Location Date of most recent EED/Factory Check

Unknown | 35385
Sonar Serial Number Processing Unit Serial Number

Hull, flat faced | 5/2/2010
Sonar Mounting Configuration Date of current offset measurement/verification

Applanix Pos MV | 5/4/2010
Description of Positioning System Date of most recent positioning system calibration

Acquisition Log

5/8/2010 | 128 | Revilla Channel | Sunny, warm, lite breeze and chop
Date Dn Local Area Wx

rock, sand, gravel | 80 to 300
Bottom Type Approximate Water Depth

Campbell, Moehl
Personnel on board

Comments

2010-128-S220
TrueHeave filename

| SV Cast #1 filename | UTC Time | Lat | Lon | Depth | Ext. Depth |
|---------------------|----------|-----|-----|-------|------------|
|---------------------|----------|-----|-----|-------|------------|

| SV Cast #2 filename | UTC Time | Lat | Lon | Depth | Ext. Depth |
|---------------------|----------|-----|-----|-------|------------|
|---------------------|----------|-----|-----|-------|------------|

Processing Log

5/8/2010 | 128 | Campbell
 Date Dn Personnel

Data converted --> HDCS_Data in CARIS

TrueHeave applied _____

SVP applied _____

Tide applied _____

Zone file 0193FA2010CORP_Rev.zdf

Lines merged

Data cleaned to remove gross fliers

Compute correctors in this order

1. Precise Timing 2. Pitch bias 3. Heading bias 4. Roll bias

Do not enter/apply correctors until all evaluations are complete and analyzed.

PATCH TEST RESULTS/CORRECTORS

| Evaluators | Latency (sec) | Pitch (deg) | Roll (deg) | Yaw (deg) |
|---------------------------|---------------|-------------|------------|-----------|
| Campbell | 0.00 | 0.20 | -0.04 | -0.32 |
| Froelich | 0.00 | -0.12 | -0.09 | 0.67 |
| Morgan | 0.00 | 0.10 | -0.09 | 0.10 |
| Jaskoski | 0.00 | 0.12 | -0.07 | -0.21 |
| | | | | |
| | | | | |
| | | | | |
| | | | | |
| | | | | |
| Averages | 0.00 | 0.08 | -0.07 | 0.06 |
| Standard Deviation | 0.00 | 0.14 | 0.02 | 0.44 |
| FINAL VALUES | 0.00 | 0.08 | -0.07 | 0.06 |

Final Values based on Averages

Resulting HVF File Name FA_S220_Rsn8160_5to750_2010

MRU Align StdDev gyro 0.44 Value from standard deviation of Heading offset values
 MRU Align StdDev Roll/Pitch 0.08 Value from averaged standard deviations of pitch and roll offset values

NARRATIVE

Entered on Dn 122 in hvf

HVF Hydrographic Vessel File created or updated with current offsets

Name: CST Morgan _____ Date: 5/10/2010
 _____ Checked again on 7/18/2010

***Fairweather* (S220) Dynamic Draft Measurement**

Lake Washington, 21 January 2010

SST Tami Beduhn & PS Grant Froelich

On Thursday, 21 January 2010 (DN 021), *Fairweather* conducted a dynamic draft measurement (DDM) on Lake Washington using post processed kinematic GPS data. The vessel sat at rest alongside the pier, then ran in the North direction at approximate speeds of 4, 6, 8 and 10 knots, holding each speed for about 4 minutes. The vessel then turned around and ran in the South direction at approximate speeds of 10, 8, 6 and 4 knots, again holding each speed for about 4 minutes and resting for approximately 5 minutes at the end. The POS/MV recorded a POSPac file the entire time from beginning rest to finish rest.

The POSPac file was processed with POSPac MMS Software using the GNSS-Inertial Processing Single Base Station Mode. The single CORS station SEAI (1 Hz) was chosen as the base station. The Lever Arm Standard Deviation was set to <3cm and then the GNSS-Inertial Processor in the Forward, Backward and Combine mode was Run.

The file was then exported out from the POSPac MMS software with an output rate of 1 sec and run through the Python Script written by LTjg Glen Rice, which includes the third order polynomial curve. The following graphs were generated.

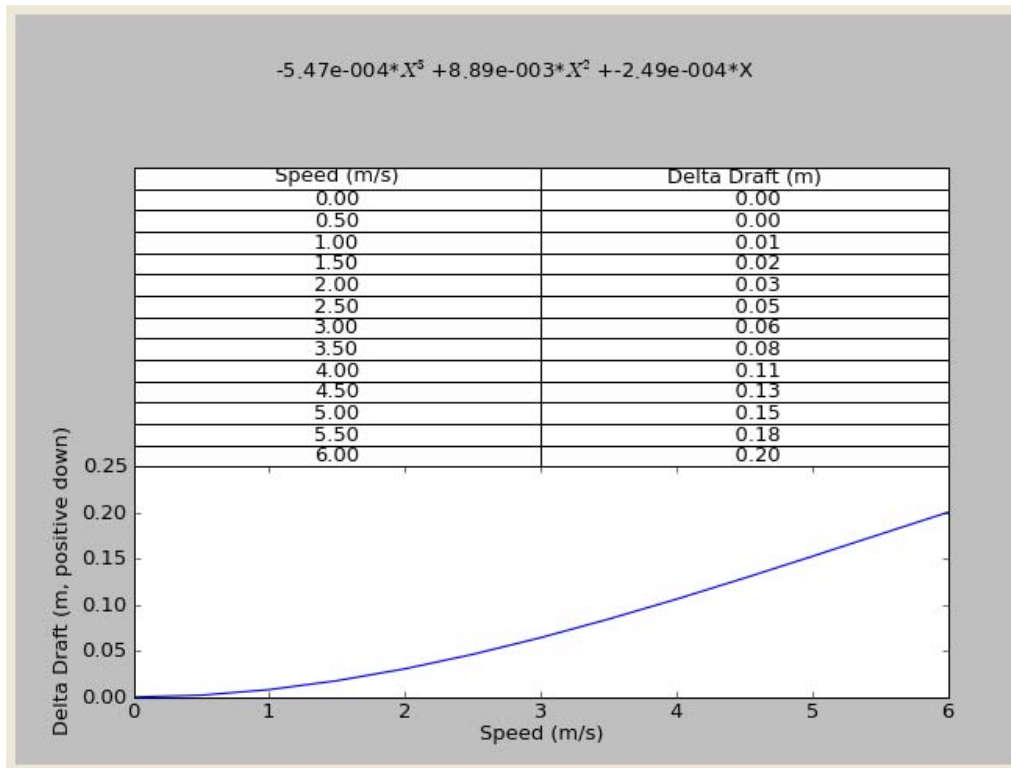

Figure 1. *Fairweather* Inverted Dynamic Draft Curve & Computed Dynamic Draft Table for Caris

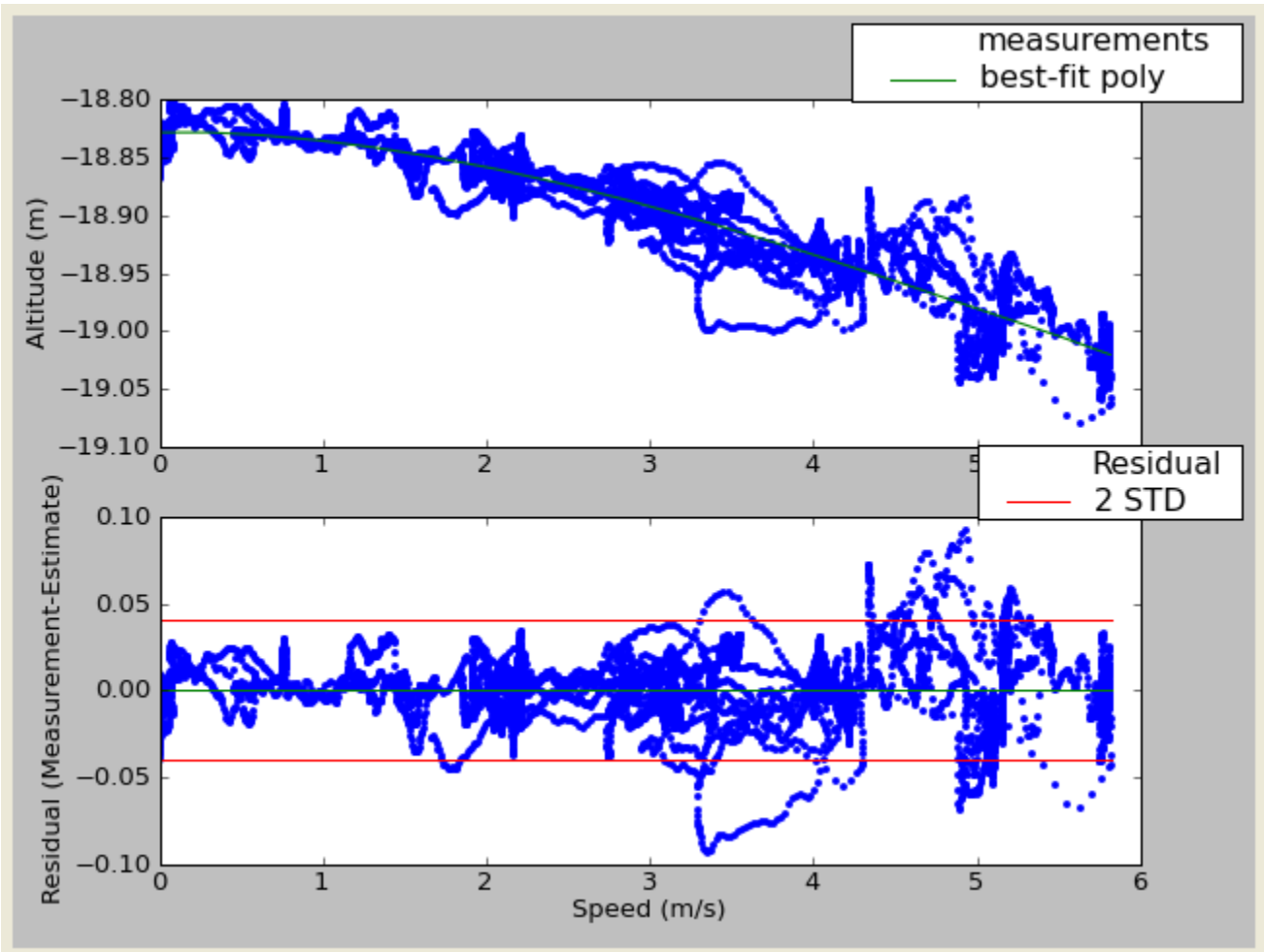
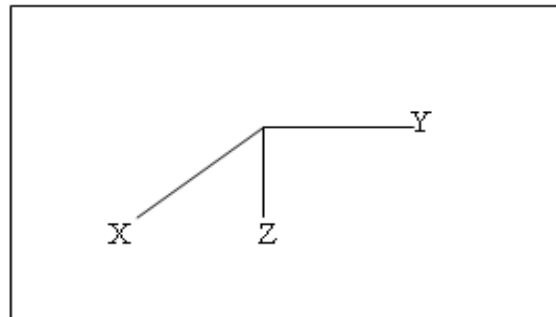
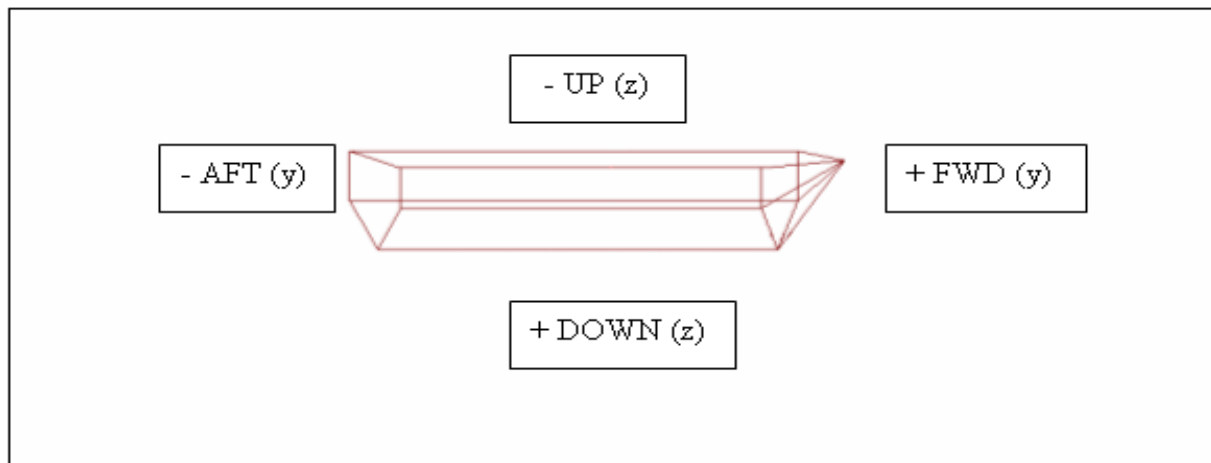
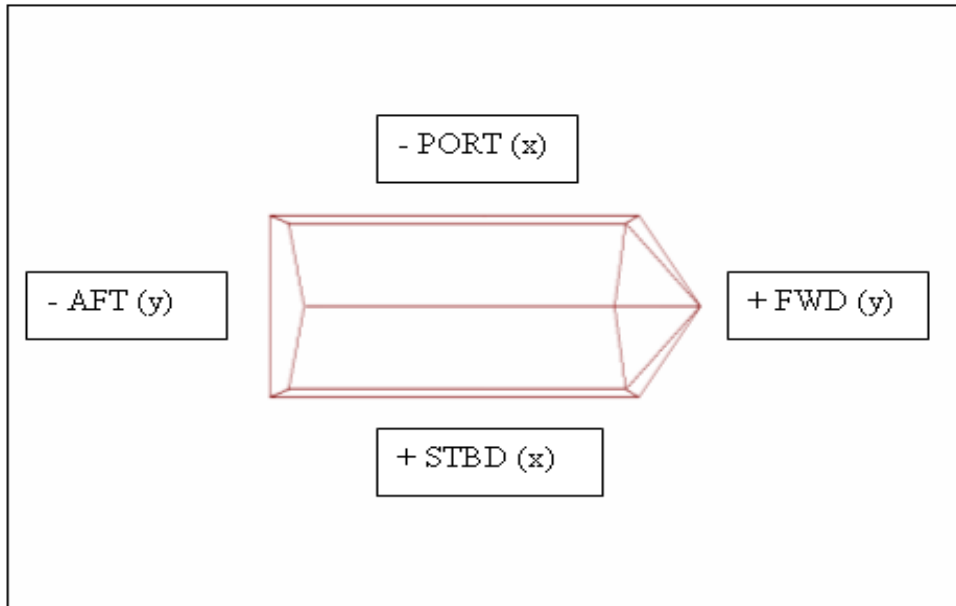

Figure 2. *Fairweather* Dynamic Draft Curve with Data Points

CARIS Coordinate System



Top Center of IMU is origin of CARIS Coordinate System

POS/MV Coordinate System

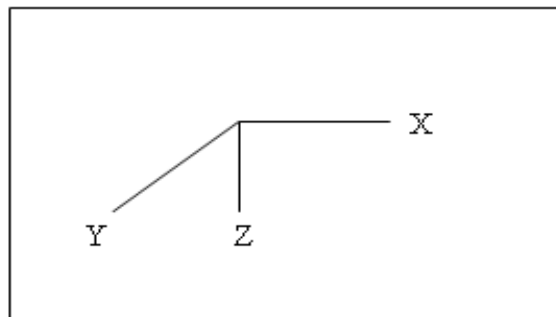
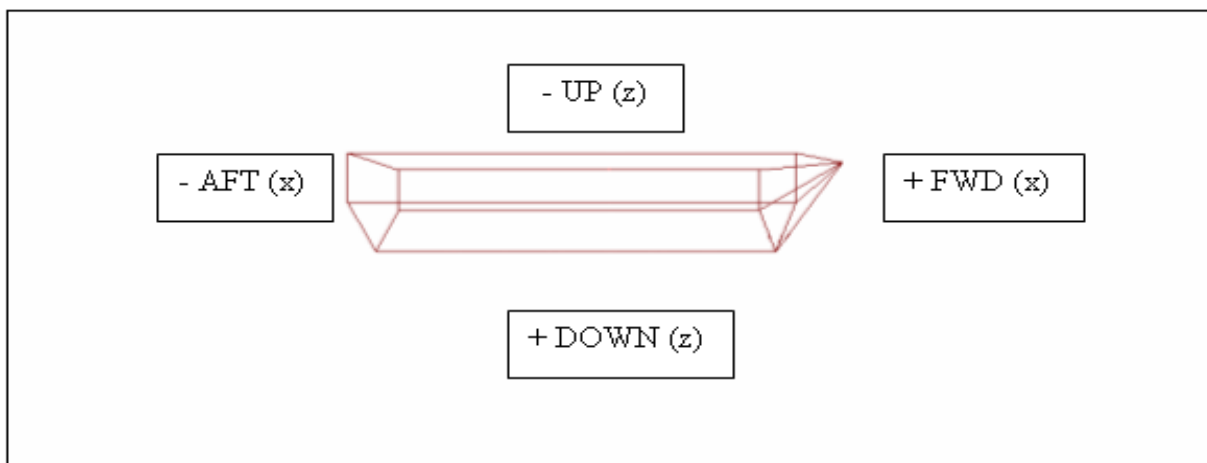
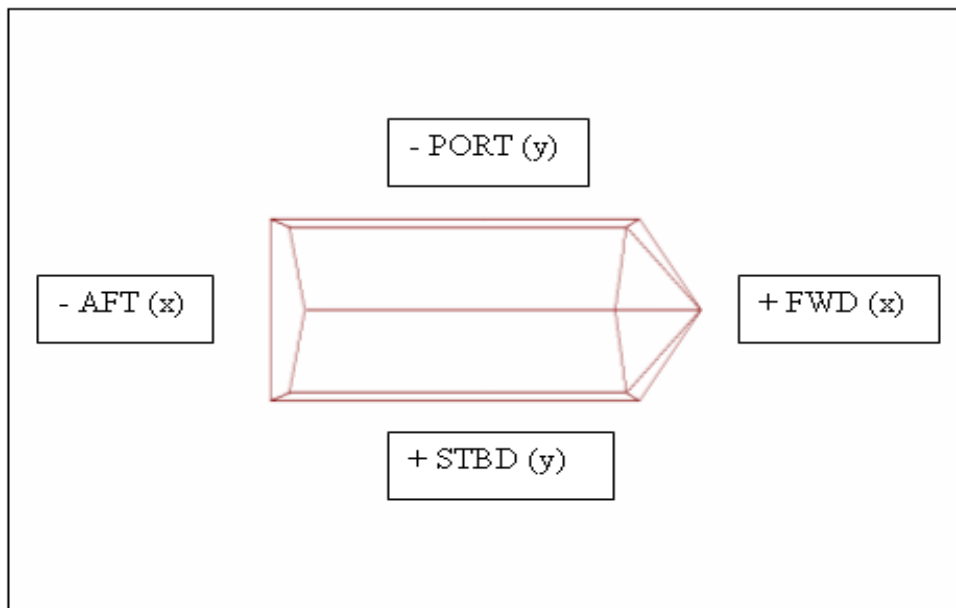

Top Center of IMU is origin of POS/MV Coordinate System

WESTLAKE Coordinate System

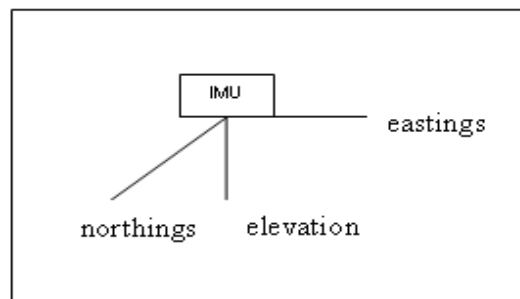
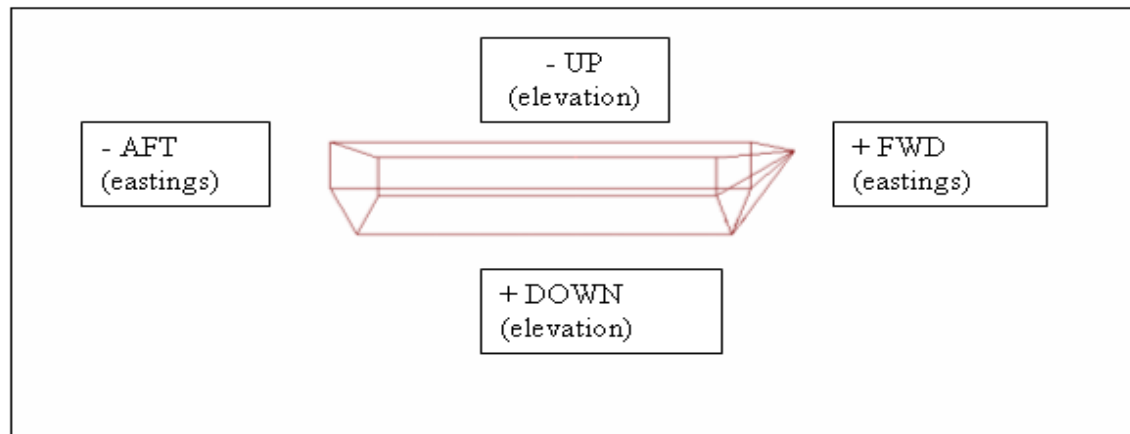
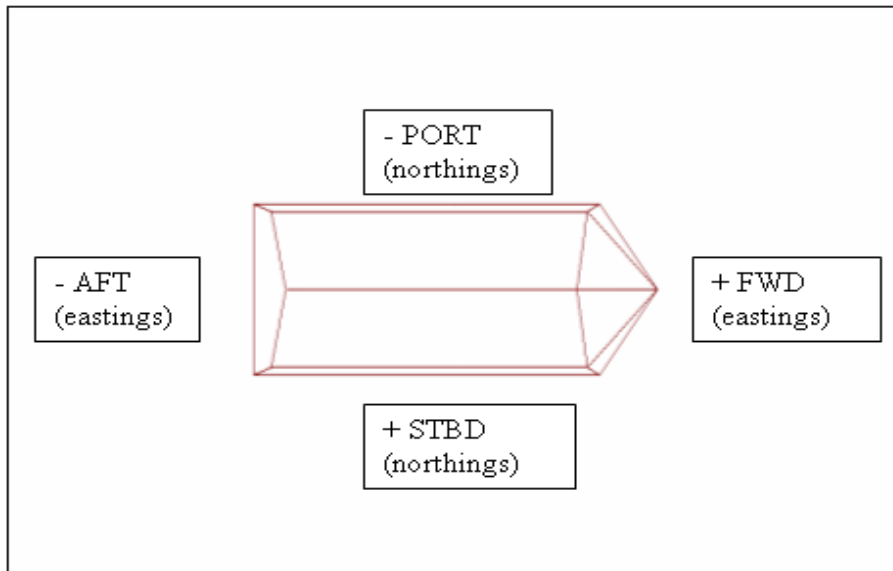

Bottom Center of IMU is origin of Westlake Coordinate System

NGS/ RESON Coordinate System

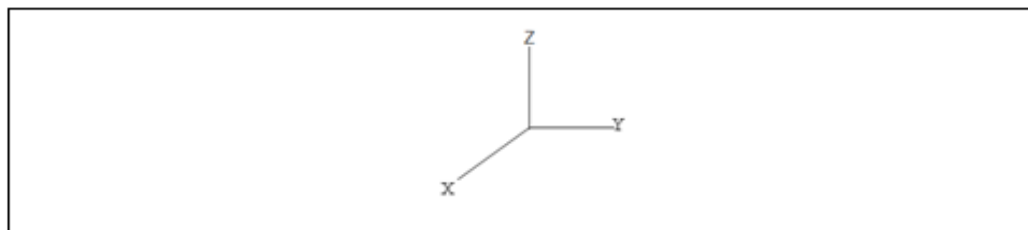
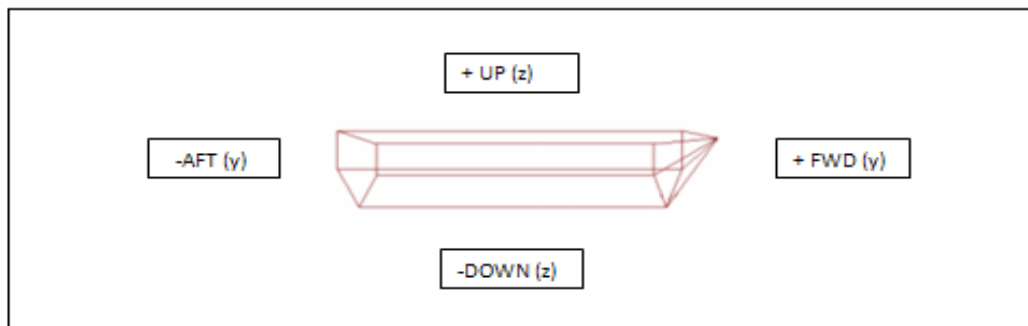
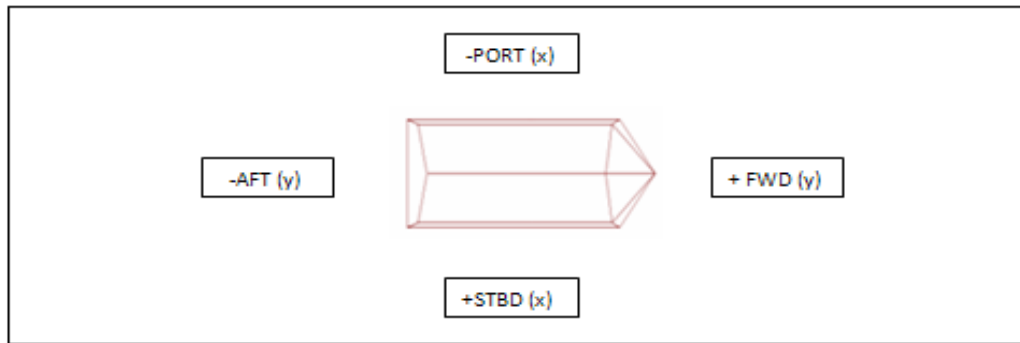

The Center of IMU is origin of NGS/ Reson System

Hypack Coordinate System

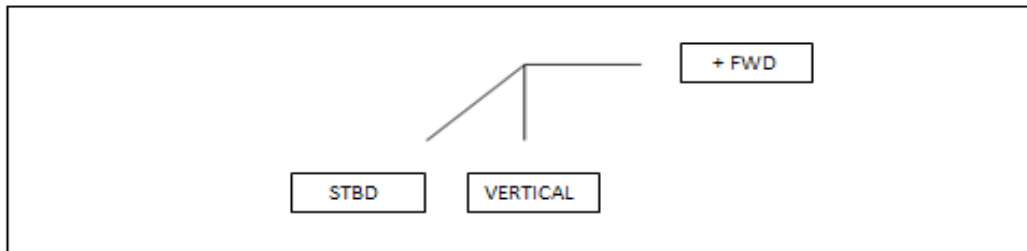
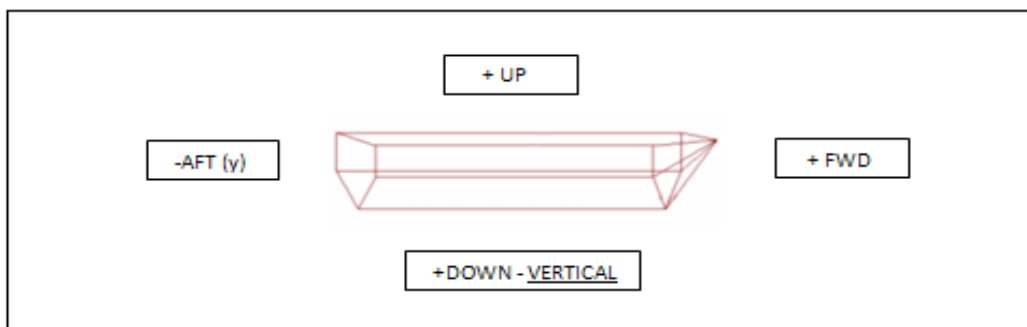
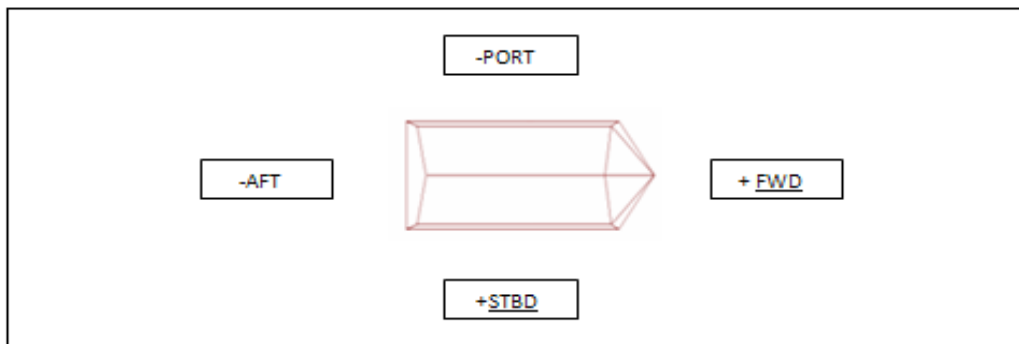

Top Center of IMU is origin of Hypack Coordinate System

Reference Surface Comparison

Frequency: 200 kHz

Resolution: 1 m

Surface Difference = Surface1 - Surface2

| Average Surface | | Surface 2 | | | | | |
|-----------------|----------------|-----------|-------|-------|-------------|--------|--------|
| | | 2805 | 2806 | 2807 | 2808(DN064) | 8160 | 7111 |
| Surface 1 | Difference (m) | | 0.008 | 0.033 | 0.019 | -0.206 | -0.322 |
| | 2805 | | | | | | |
| | 2806 | | | | | | |
| | 2807 | | | | -0.009 | | |

Standard Deviation

| | | Surface 2 | | | | | |
|-----------|------|-----------|-------|-------|-------|-------|-------|
| | | 2805 | 2806 | 2807 | 2808 | 8160 | 7111 |
| Surface 1 | 2805 | | 0.113 | 0.14 | 0.213 | 0.987 | 0.956 |
| | 2806 | | | 0.121 | 0.224 | | |
| | 2807 | | | | 0.556 | | |

Frequency: 400 kHz

Resolution: 1 m

Surface Difference = Surface1 - Surface2

| Average Surface | | Surface 2 | | | | |
|-----------------|----------------|-----------|--------|--------|-------------|-------------|
| | | 2805 | 2806 | 2807 | 2808(DN095) | 2808(DN064) |
| Surface 1 | Difference (m) | | -0.078 | -0.044 | -0.312 | -0.05 |
| | 2805 | | | | | |
| | 2806 | | | | | |
| | 2807 | | | | -0.27 | -0.007 |

Standard Deviation

| | | Surface 2 | | | | |
|-----------|------|-----------|-------|-------|-------|------|
| | | 2805 | 2806 | 2807 | 2808 | 2808 |
| Surface 1 | 2805 | | 0.128 | 0.123 | 0.304 | |
| | 2806 | | | 0.11 | 0.309 | |
| | 2807 | | | | 0.281 | |

200 kHz to 400 kHz comparison

Resolution: 1 m

Surface Difference = Surface1 - Surface2

| Average Surface | | Surface 2 400kHz | | | | |
|-----------------|----------------|------------------|-------|------|-------------|-------------|
| | | 2805 | 2806 | 2807 | 2808(DN095) | 2808(DN064) |
| Surface 1 | Difference (m) | | 0.017 | | | |
| | 2805 | | | | | |
| | 2806 | | | | | |
| | 2807 | | | | | |
| 200KHz | 2808(DN095) | | | | -0.23 | |
| | 2808(DN064) | | | | | 0.031 |

Standard Deviation

| | | Surface 2 400 kHz | | | | |
|-----------|-------------|-------------------|----------|------|-------------|-------------|
| | | 2805 | 2806 | 2807 | 2808(DN095) | 2808(DN064) |
| Surface 1 | 2805 | | 0.125957 | | | |
| | 2806 | | | 0.11 | | |
| | 2807 | | | | 0.525 | |
| 200KHz | 2808(DN095) | | | | 0.364 | |
| | 2808(DN064) | | | | | 0.362 |

Dual Side Scan Sonar and Multibeam Acquisition SYSTEM READINESS REPORT 2010

Vessel: 2808
Sonars: Reson 7125 MBES
 Klein 5000 SSS
Written By: LT Jaskoski
Report Date: 06-APR-2010

Background:

Fairweather 2010 planned operations call for dual acquisition of hull mounted Klein System 5000 side scan sonar data (SSS) and Reson 7125sv multibeam echosounder data (MBES). Several acquisition methods (variables: ping triggering, SSS pulse length, beam spacing and MBES frequency) were investigated to determine best practices for such operations.

Calibration Location, Date, and Personnel:

The dual acquisition methods were performed at the entrance to Juanita Bay in Lake Washington, WA (figure 1). The area was chosen for several reasons. First, the area is bisected by a cable area this provided the opportunity to determine the ability of each setting to resolve linear objects across both port and starboard returns in the SSS trace. Second, the relatively shallow, flat area was chosen as a mimic of the bathymetry expected in the project areas where SSS will be the primary mode of hydrography. The shallow area was also intended to test the interference effects of increased MBES ping rate on the SSS trace. The slope area was chosen to determine the effects of changing MBES range scale on the SSS trace.

Personnel: SST Beduhn, LT Jaskoski
Coxwain: AB Marcum
Location: Lake Washington, WA
Date: 01-MAR-2010; DN 060

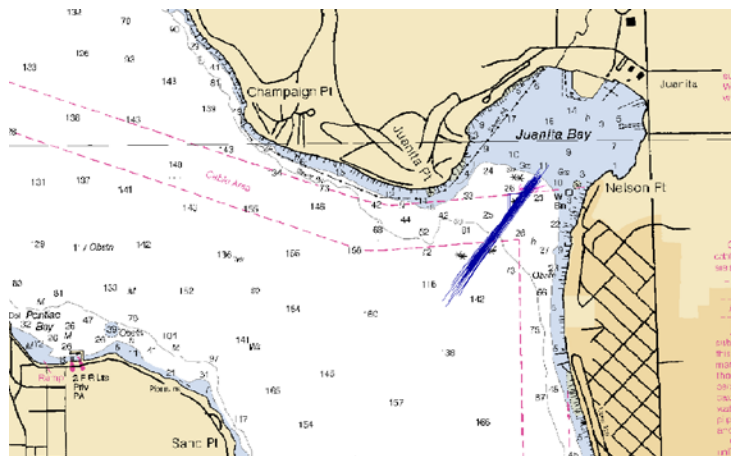

Figure 1: Location of dual system acquisition practices investigation, Chart 18447

Procedure for dual acquisition practices investigation:

Imagery and bathymetry data were simultaneously acquired over a single survey line. User controlled settings were manipulated by the hydrographer. Each setting configuration was used for one inshore and one offshore line to determine the effects of changing range scale and ping rate in both the up-slope and down-slope direction. The settings manipulated in the MBES were range scale (as needed/depth dependent), frequency (200kHz/400kHz) number of beams (256/512), beam spacing (equi-distant and equi-angular) and Trigger input (on or off). Settings manipulated in the SSS were pulse length (50µs/100µs), SSS range was set at 100m. Imagery data were reviewed in Caris SIPS to determine the extent of interference on the trace and bottom track capabilities, and the resultant effect on the operator's ability to determine significant point and linear contacts

Results:

For all settings linear contacts could be determined by the operator across port and starboard returns in the processed data.

Interference was given the values of “very light”, “light” and “substantial.” Interference was considered to be very light if it did not impinge upon the operator's ability to determine a 1m³ object in the outer beams and had no effect on bottom track (figure 2). Interference was considered light if it did not impinge upon the operator's ability to determine a 1m³ object in the outer beams, but had a negative effect on bottom track (figure 3). Substantial interference was deemed to be present if it impinged upon the operator's ability to determine a 1m tall object in the outer beams (figure 4). For all settings in which external triggering was disabled in the MBES substantial interference was noted in the line. Bottom track ability was degraded less by interference with a SSS pulse length of 100µs than 50µs.

Lightest interference was noted with the following settings: 400kHz frequency, 512 beams, equi-angular beam spacing, triggering input on, and SSS pulse length set to 100µs.

The nominal ping rate of a Klein 5000 SSS is 7Hz, if triggering is enabled the resultant max ping rate of the MBES will also be 7Hz. At typical survey speeds (appx 6-9 knots) the along-track ping density at 7Hz can be expected to be between 2.2-1.5 pings per meter, this is adequate ping density for use in this application.

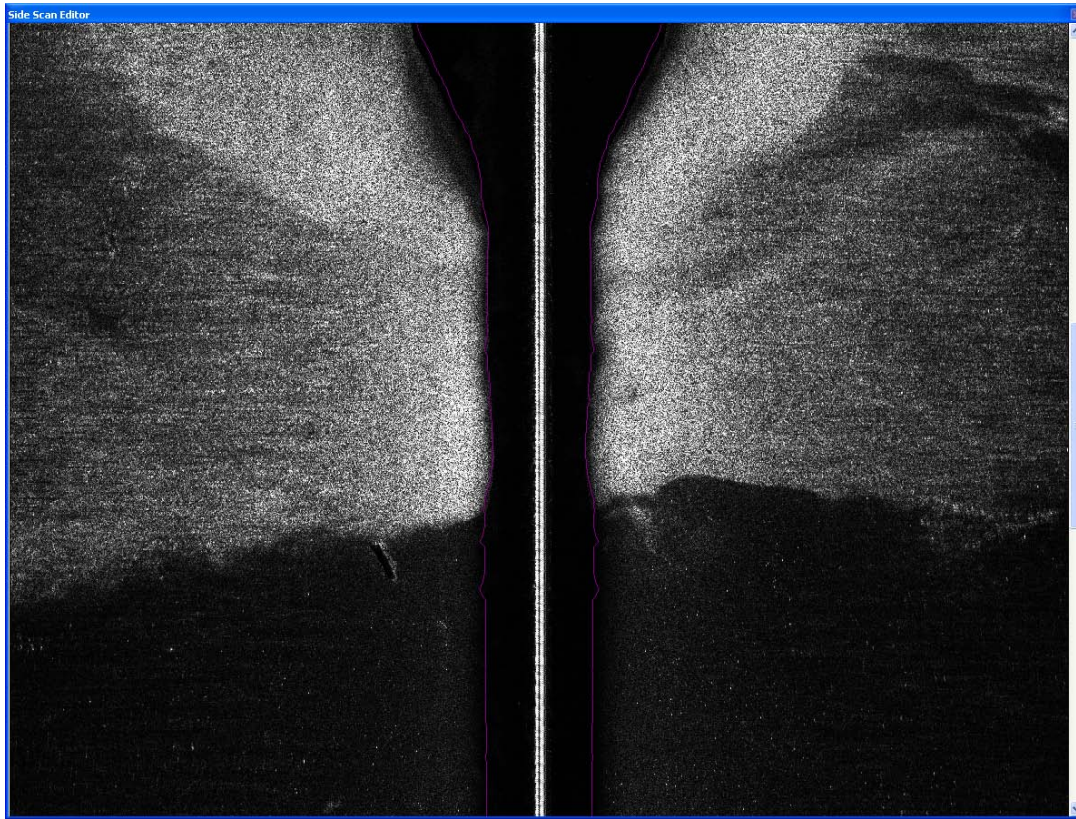

Figure 2: Very light interference, interference will not negatively affect processing SSS data

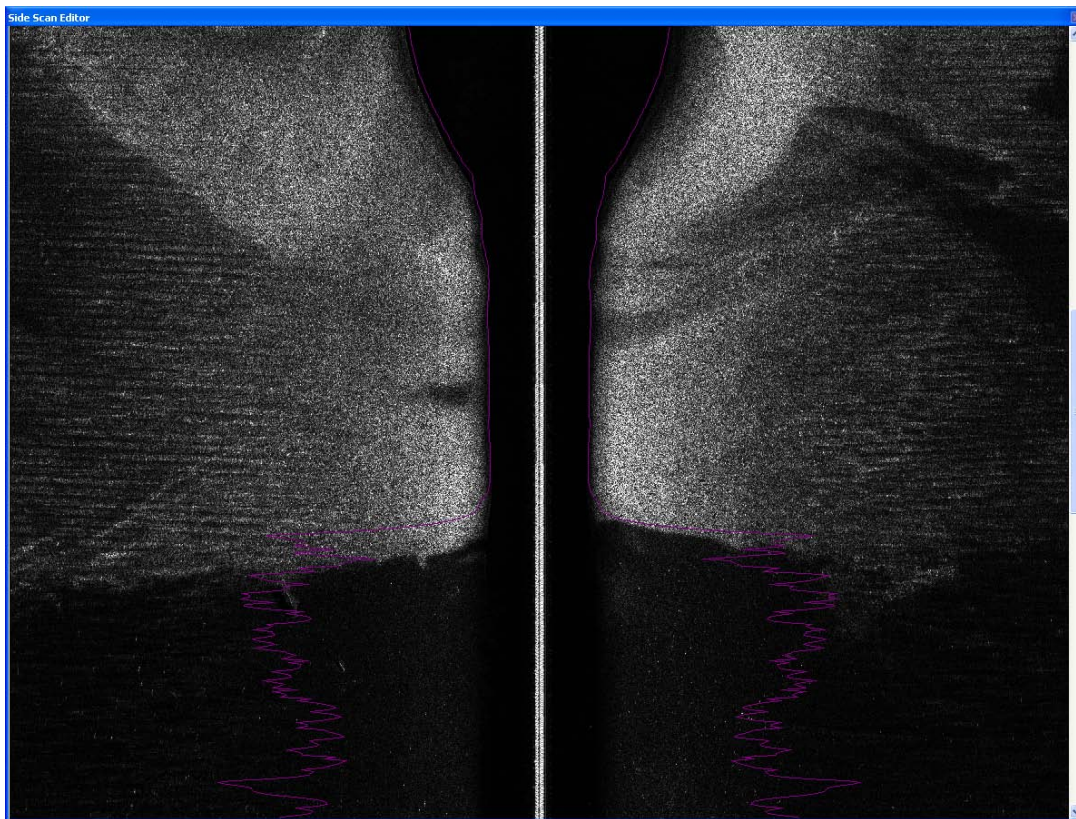

Figure 3: Light interference, bottom track locks on false return of interference over softer bottom type.

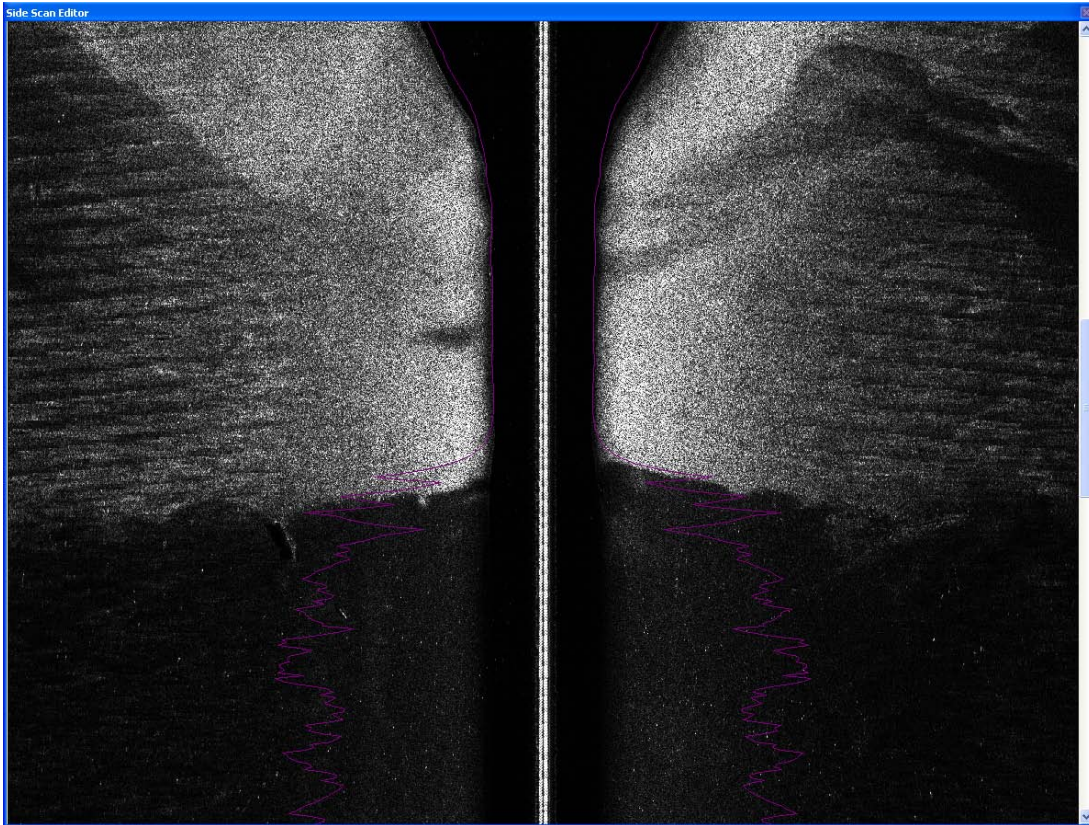

Figure 4: Substantial interference, operator unable to reliably determine significant contacts in outer beams .

Recommendations

It is the recommendation that the best practices for acquiring simultaneous hull mounted SSS and MBES data be the following:

Klein SSS 100 μ s pulse length
 Triggering enabled

Reson 7125 400kHz, 512 beams, Equi-angular spacing
 External triggering enabled

It is also recommended that the MBES pulse length be limited to less than one half of the SSS pulse length (>50 μ s)

Appendix III

Total Propagated Uncertainty (TPU)

Fairweather TPU Values

| | | | | |
|--|---------------------------------------|-------------------------------|-------------------|---------------------------------|
| | FAIRWEATHER SURVEY | | Appendix III | Process Owner Survey |
| | Documents Title FA_TPU_Values_2010 | Last update August 9, 2010 | Version 2010.1 | Approval Date August 9, 2010 |

| Offsets | | | | | | | |
|---------|--------------------|------------------|------------------|--------------|--------------|--------------|--------------|
| | Vessel | FAIRWEATHER-S220 | FAIRWEATHER-S220 | 2805 | 2806 | 2807 | 2808 |
| | Sonar System | Reson 7/8111 | Reson 8160 | Reson 7125 | | Reson 7125 | |
| | Frequency | | | 200kHz | 400kHz | 200kHz | 400kHz |
| | Positioning System | POS/MV | POS/MV | POS/MV | POS/MV | POS/MV | POS/MV |
| | | Model 320 V4 | Model 320 V4 | Model 320 V4 | Model 320 V4 | Model 320 V4 | Model 320 V4 |
| Offsets | MRU to Trans X | 2.868 | 0.493 | 0.004 | -0.013 | 0.019 | 0.004 |
| | MRU to Trans Y | 8.252 | 7.665 | 0.245 | 0.254 | 0.244 | 0.250 |
| | MRU to Trans Z | 4.430 | 4.520 | 0.482 | 0.481 | 0.481 | 0.477 |
| | Nav to Trans X | 2.071 | -0.304 | 0.686 | 0.624 | 0.804 | 0.685 |
| | Nav to Trans Y | 20.144 | 19.557 | 1.051 | 1.087 | 1.056 | 1.086 |
| | Nav to Trans Z | 17.499 | 17.588 | 3.656 | 3.617 | 3.628 | 3.637 |
| | Trans Roll | 0.00 | 0.00 | 0.000 | 0.000 | 0.000 | 0.000 |

| Standard Deviation | | | | | | | |
|--------------------|----------------------|-------------------|-------------------|-------------------|-------------------|-------------------|-------------------|
| | Vessel | FAIRWEATHER-S220 | FAIRWEATHER-S220 | 2805 | 2806 | 2807 | 2808 |
| | Sonar System | Reson 7111 | Reson 8160 | Reson 7125 | | Reson 7125 | |
| | Frequency | | | 200kHz | 400kHz | 200kHz | 400kHz |
| | Positioning System | POS/MV | POS/MV | POS/MV | POS/MV | POS/MV | POS/MV |
| | | Model 320 V4 | Model 320 V4 | Model 320 V4 | Model 320 V4 | Model 320 V4 | Model 320 V4 |
| Motion Sensor | Motion Gyro (deg) | 0.02 | 0.02 | 0.02 | 0.02 | 0.02 | 0.02 |
| | Heave% Amp | 5 | 5 | 5 | 5 | 5 | 5 |
| | Heave (m) | 0.05 | 0.05 | 0.05 | 0.05 | 0.05 | 0.05 |
| | Roll (deg) | 0.02 | 0.02 | 0.02 | 0.02 | 0.02 | 0.02 |
| | Pitch (deg) | 0.02 | 0.02 | 0.02 | 0.02 | 0.02 | 0.02 |
| | Position Nav (m) | 0.5* | 0.5 | 0.5 | 0.5 | 0.5 | 0.5 |
| | Vessel Speed (m/s) | 0.03 | 0.03 | 0.03 | 0.03 | 0.03 | 0.03 |
| Latency | Timing Trans (s) | 0.005 | 0.005 | 0.005 | 0.005 | 0.005 | 0.005 |
| | Nav Timing (s) | 0.005 | 0.005 | 0.005 | 0.005 | 0.005 | 0.005 |
| | Gyro Timing (s) | 0.005 | 0.005 | 0.005 | 0.005 | 0.005 | 0.005 |
| | Heave Timing (s) | 0.005 | 0.005 | 0.005 | 0.005 | 0.005 | 0.005 |
| | Pitch Timing (s) | 0.005 | 0.005 | 0.005 | 0.005 | 0.005 | 0.005 |
| Vessel Offsets | Offset X (m) | 0.007 | 0.007 | 0.006 | 0.004 | 0.007 | 0.006 |
| | Offset Y (m) | 0.007 | 0.007 | 0.006 | 0.004 | 0.007 | 0.006 |
| | Offset Z (m) | 0.008 | 0.008 | 0.006 | 0.004 | 0.007 | 0.006 |
| Waterline | Loading | 0.067 | 0.067 | 0.017 | 0.041 | 0.028 | 0.025 |
| | Draft (m) | 0.068 | 0.068 | 0.018 | 0.041 | 0.028 | 0.026 |
| | DeltaDraft (m) | 0.04 | 0.04 | 0.05 | 0.03 | 0.07 | 0.04 |
| MRU Alignment | MRU alignStdev gyro | 0.060 | 0.440 | 0.15 | 0.03 | 0.05 | 0.03 |
| | MRU align roll/pitch | 0.080 | 0.080 | 0.05 | 0.03 | 0.03 | 0.06 |
| Tides | Tide Meas (m) | 0.01 | 0.01 | 0.01 | 0.01 | 0.01 | 0.01 |
| | Tide Zoning (m) | Project Dependent | Project Dependent | Project Dependent | Project Dependent | Project Dependent | Project Dependent |
| Sound Velocity | SV Meas (m/s) | 0.5 | 0.5 | 1.0 | 1.0 | 1.0 | 1.0 |
| | Surface SV (m/s) | 0.5 | 0.5 | 0.5 | 0.5 | 0.5 | 0.5 |

| Vessel Configuration File | | Status |
|---------------------------|----------------------------------|---------------------|
| Compute TPE Dialog Box | | Finalized |
| | | Finalized |
| | | Finalized |
| | | Finalized |
| | | Finalized |
| | | Finalized |
| | | Finalized |
| | | Finalized |
| | | Finalized |
| | | Finalized |
| | | Finalized |
| | | Finalized |
| | | Finalized |
| | | Finalized |
| | | Finalized |
| | | Finalized |
| | | Finalized |
| | | Project Dependent** |
| | Default=0.2, Project Dependent** | |
| | Defaults, Project Dependent** | |
| | Defaults, Project Dependent** | |

*Position Nav adjusted in the HVF to 5m when acquiring in Coarse Acquisition mode, additional information will be submitted in the DAPR and/or the DR.
 **Default values listed, descriptive report will list actual values applied if supplied with Project Instructions or calculated with the Sound speed estimator.
 ^MRU values may change if new patch test values are used.