

W00272

NOAA FORM 76-35A

U.S. DEPARTMENT OF COMMERCE
NATIONAL OCEANIC AND ATMOSPHERIC ADMINISTRATION
NATIONAL OCEAN SURVEY

DESCRIPTIVE REPORT

Type of Survey **Hydrographic Multibeam Survey**
Project No. **OSD-AHB-05**
Registry No. **W00272**

LOCALITY

State **Maine and New Hampshire**
General Locality **Isle of Shoals**
Sub-locality **Appledore Island/Gosport Harbor**

2005

UNH Summer Hydrographic Field Course 2005

LIBRARY & ARCHIVES

DATE

HYDROGRAPHIC TITLE SHEET

W00272

INSTRUCTIONS – The Hydrographic Sheet should be accompanied by this form, filled in as completely as possible, when the sheet is forwarded to the Office.

FIELD No

State Maine/New Hampshire

General Locality Isle of Shoals

Sub-Locality Appledore Island/Gosport Harbour

Scale 1:10,000 Date of Survey 6/07/05 - 6/20/05

Instructions dated _____ Project No. OSD-AHB-05

Vessel R/V Coastal Surveyor

Chief of party Andrew Armstrong, University of New Hampshire

Surveyed by UNH CCOM students

Soundings by echo sounder, hand lead, pole MBES

Graphic record scaled by _____

Graphic record checked by _____ Automated Plot _____

Verification by Atlantic Hydrographic Branch

Soundings in fathoms *feet* at MLW MLLW MLLW

REMARKS: _____

All time zones are in UTC; UTM zone 19N; survey conducted in WGS 84

The purpose of this survey is to provide contemporary surveys to update National Ocean Service (NOS) nautical charts. All separates are filed with the hydrographic data. Any revisions to the Descriptive Report (DR) generated during office processing are shown in bold red italic text. The processing branch maintains the DR as a field unit product, therefore, all information and recommendations within the body of the DR are considered preliminary unless otherwise noted. The final disposition of surveyed features is represented in the OCS nautical chart update products. All pertinent records for this survey, including the DR, are archived at the National Geophysical Data Center (NGDC) and can be retrieved via <http://www.ngdc.noaa.gov/>.

TABLE OF CONTENTS

LIST OF FIGURES	ii
LIST OF TABLES	iii
Introduction.....	4
A. PROJECT	2
A.1. Area Surveyed.....	2
A.2. Affected charts	3
B. DATA ACQUISITION AND PROCESSING	4
B.1. Equipment	4
B.1.1. Survey vessel	4
B.1.2. Hardware Systems Inventory	5
B.1.3. Echo sounding equipment.....	5
B.1.4. Position, heading and motion reference systems	6
B.1.5. Sound speed measurement systems	7
B.1.6. Data acquisition software.....	7
B.1.7. Data processing software	7
B.2. Quality Control	8
B.2.1. Crosslines	8
B.2.2. Uncertainty.....	8
B.2.3. Junctions	8
B.2.4. Data Density	10
B.3. Corrections to echosoundings	11
B.3.1. Vessel offsets	11
B.3.2. Patch test	11
B.3.3. Static draft.....	11
B.3.4. Dynamic draft	11
B.3.5. Heave, pitch and roll correctors.....	12
B.3.6. Sound speed corrections	12
C. VERTICAL AND HORIZONTAL CONTROL	13
C.1. Vertical control	13
C.2. Horizontal control	13
D. RESULTS AND RECOMMENDATIONS	14
D.1. Chart comparison	14
D.1.1. Comparison of depth curves	23
E. APPROVAL SHEET	24

LIST OF FIGURES

Figure 1- Survey limits	2
Figure 2- Potentially affected NOAA charts in the vicinity of the Isle of Shoals	3
Figure 3 - RV Coastal Surveyor.....	4
Figure 4 - Data flow diagram for the RV Coastal Surveyor	5
Figure 5 – Survey junctions.	9
Figure 6 - Sounding data density as computed in CARIS HIPS.....	10
Figure 7 –Final 1 m CUBE surface of the 2005 Isle of Shoals survey (depths in meters).....	14
Figure 8 - Area to the north of Appledore Island	15
Figure 9 - Erroneous soundings north of Appledore Island.....	16
Figure 10 - Discrepancies in depth curves to the northwest of Appledore Island	17
Figure 11 - Difference in charted soundings and survey depths to the west of Appledore	18
Figure 12 - Southwest of Appledore Island.....	19
Figure 13 - Bathymetry to the north of Smuttynose Island and Gosport Harbor	20
Figure 14 - Area to the northwest of Halfway Rocks	21
Figure 15 - Area surrounding position 42° 58' 58.43"N, 070° 38' 15.23"W.....	22
Figure 16 - Area surrounding position 42° 59' 34.28 N, 070° 37' 51.05"W	22
Figure 17 - Comparison of survey depth ranges and charted depth curves	23

LIST OF TABLES

Table 1- Survey personnel	4
Table 2- Survey statistics	4
Table 3- The coordinate extents of the survey area in latitude and longitude	2
Table 4- Charts affected by the 2005 Isle of Shoals multibeam survey (updated Feb/2012)	3
Table 5 - RV Coastal Surveyor specifications	4
Table 6 - Hardware systems	5
Table 7 - EM 3002D specifications (sourced from EM 3002 spec. sheet, Kongsberg. Inc).	6
Table 8 - Specifications for the Applanix POS MV	6
Table 9 -- Specifications for the Applied Microsystems SVPlus	7
Table 10 - CARIS HIPS surface difference analysis for crosslines and mainscheme lines	8
Table 11 - Multibeam and Lidar surveys of the area which junction with the 2005 multibeam survey	9
Table 12 - Corrections after patch test	11
Table 13 - Dynamic draft corrections	12
Table 15 - Color bar for surveyed depth ranges corresponding to charted depth curves	23
Table 14 - NOAA feet to meters conversion	23

Introduction

The following descriptive report was compiled by the Center for Coastal and Ocean Mapping - Joint Hydrographic Center (CCOM – JHC) at the University of New Hampshire with multibeam echo sounder data acquired during June 2005 in the vicinity of the Isle of Shoals, New Hampshire. The data were processed in 2009 (refer to Appendix I *Processing Log 2009*) for comparative purposes with a submitted descriptive report from that year (registry no. W00206), and the processed data and metadata compiled to form a report in 2012 with the objective of providing updates for existing nautical charts of the area.

The survey area encompasses an area 1.82 nm² to the west of Appledore and Smuttynose Islands in the Isle of Shoals, New Hampshire (see *Survey Area Section 2.1* for graphic). Full bottom multibeam echosounder coverage was achieved within the limits specified by the National Ocean Service HSSD for this survey.

Participants in the survey are listed below in Table 1 and further survey summary statistics in Table 2.

Table 1- Survey personnel

Vessel Personnel	Supervising Faculty	Participants	
Ben Smith	Andrew Armstrong	Taisei Morishita	Hugo Montoro
		Lorraine Robidoux	Abubakar Mustapha
		Benjamin Hell	Shereen Sharma
		Walter Peralta	Clive Angwenyi
			Srinivas Karlipata

Table 2- Survey statistics

2005 Isles of Shoals survey	
North/south distance	1.55 nm
East/West distance	1.89 nm
Survey area	1.82 nm ²
Total main scheme survey lines	56.1 nm
Total survey crosslines	5.25 nm
Shoreline investigation lines	16.9 nm
Bottom samples	0
Data acquisition start date	06/07/2005
Data acquisition finish date	06/20/2005

A. PROJECT

A.1. Area Surveyed

The Isles of Shoals are a group of islands and rocky shoals approximately 4 nm southeast of Portsmouth Harbor, New Hampshire. The survey area is bounded by the approximate coordinates listed in Table 3 and illustrated by Figure 1, which encompasses a region to the northwest of Appledore Island and Smuttynose islands. Data were acquired on 7, 8, 9, 20, June 2005. A total of 78.3 lineal miles were run including cross lines and shoreline investigations. No bottom samples were taken during the survey.

Depths ranged in the survey area from approximately 0.25 m to 35 m with reference to Mean Lower Low Water (MLLW) .

Table 3- The coordinate extents of the survey area in latitude and longitude

<i>Point Location</i>	<i>Latitude</i>	<i>Longitude</i>
NW corner	N 42° 59' 59.65''	W 070° 38' 56.50''
SW corner	N 42° 58' 29.30''	W 070° 38' 53.40''
SE corner	N 42° 58' 39.42''	W 070° 36' 36.72''
NE corner	N 43° 00' 00.14''	W 070° 36' 47.00''

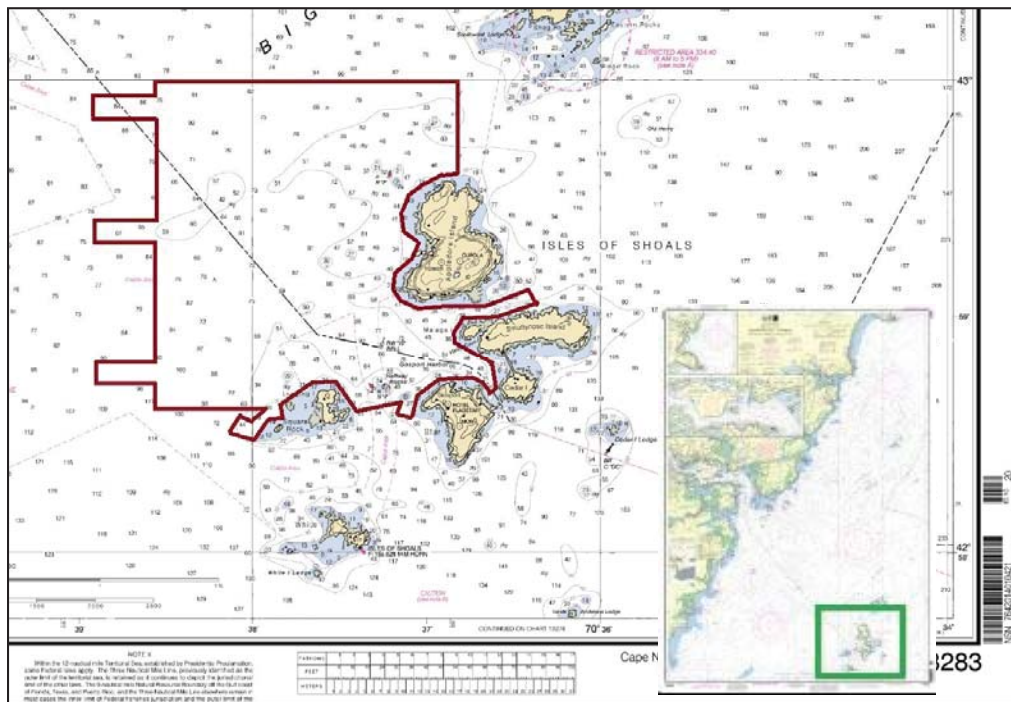

Figure 1- Survey limits (red) in the vicinity of the Isles of Shoals, NH. Details of the charted area taken from NOAA chart no. 13283 (1:20,000). Chart inset indicates the location of the Isle of Shoals in relation to the Portsmouth Harbor coastline.

A.2. Affected charts

Table 4 lists the raster and corresponding electronic charts that may be affected by the 2005 multibeam sonar survey. The charts range in scale from 1:20,000 to 1:500,000 and Figure 2 indicates the geographical coverage of the affected charts in relation to the survey limits. Chart 13283 was the primary source used for the planning and execution of this survey.

Table 4- Charts affected by the 2005 Isle of Shoals multibeam survey (updated Feb/2012)

Electronic (ENC)	Raster (RNC)	Scale	Edition Number	Issue Date
US5NH02M	13283	1:20,000	21	03/2011
US4MA19M	13274	1:40,000	28	04/2011
US4MA04M	13278	1:80,000	27	10/2009
US3EC10M	13260	1:378,838	40	05/2007
US3EC05M	13009	1:500,000	35	04/2010

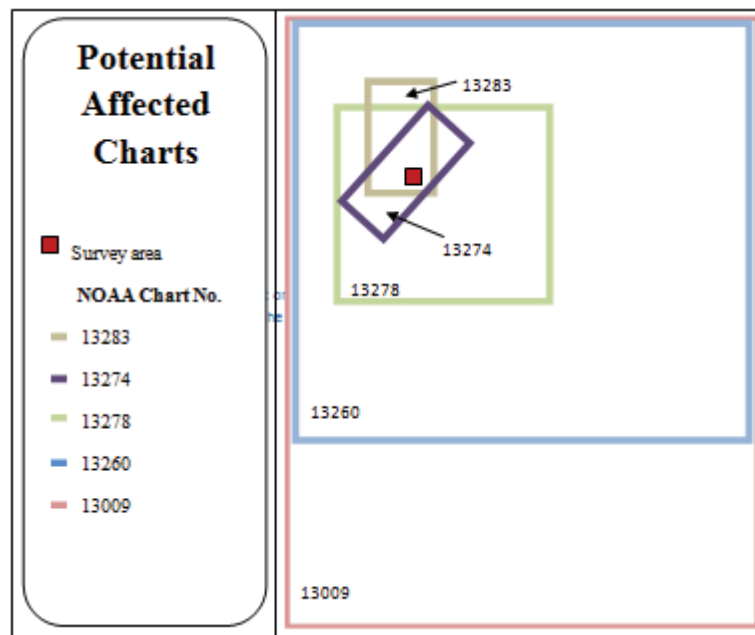

Figure 2- Potentially affected NOAA charts in the vicinity of the Isle of Shoals

B. DATA ACQUISITION AND PROCESSING

B.1. Equipment

B.1.1. *Survey vessel*

The Coastal Surveyor (Figure 3) is a purpose built vessel designed specifically for coastal multibeam hydrography. It is integrated with a motor-driven ram system that provides an ideal mount for a range of multibeam and other sonar systems. The vessel incorporates an active roll stabilization feature to limit vessel motions detrimental to multibeam operations. Refer to Table 5 for vessel



Figure 3 - RV Coastal Surveyor

specifications and to Appendix II (*Vessel Description and Offsets*) for complete specifications and offsets used in the survey. Data flow for the vessel is illustrated in Figure 4.

Table 5 - RV Coastal Surveyor specifications

	R/V Coastal Surveyor
Official Number	999206
USCG	Designated Research Vessel, subchapter "C"
Length Overall	12.2 m
Beam	3.7 m
Draft, Maximum	1.8 m
Tonnage	16 GRT, 11 DWT
Min. and Max. Survey Speed	2.5 - 10 knots
Attitude & Positioning Equipment	POS/MV V3
Type of operations	Research vessel

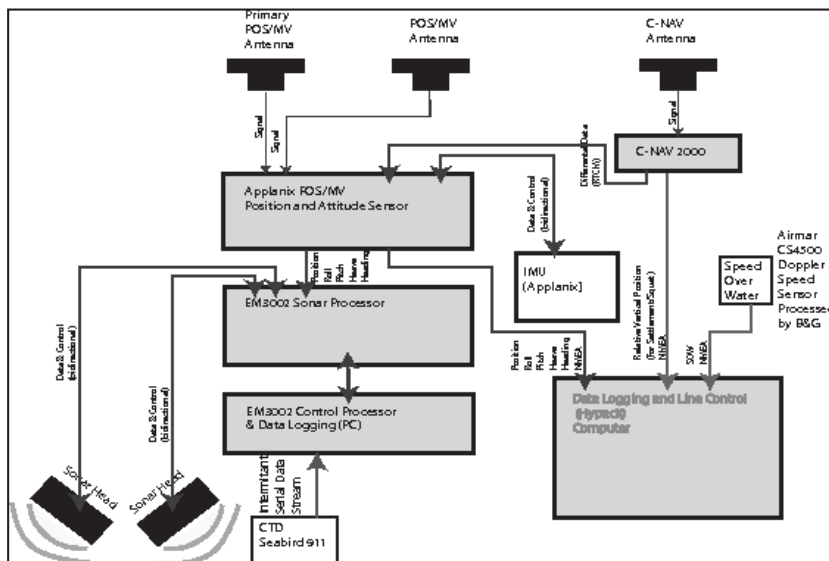

Figure 4 - Data flow diagram for the RV Coastal Surveyor

B.1.2. *Hardware Systems Inventory*

The primary systems and equipment used in the survey on the RV Coastal Surveyor are listed in Table 6. Further documentation is supplied in Appendix III (*Equipment Description*)

Table 6 - Hardware systems

	<i>Equipment</i>	<i>Manufacturer & Model</i>
<i>Echo Sounding</i>	Multibeam Echosounder	Simrad EM 3002 dual head
	Operator Station	Simrad HW-S10
	Processing Unit	Simrad EM 3002 PU
<i>Attitude/ Positioning</i>	Position Compute System (PCS)	Applanix 320 V.4 POS/MV
	Inertial Motion Unit (IMU)	Applanix IMU-200 POS/MV
<i>Horizontal Positioning</i>	Differential GPS Receiver	C-Nav. 2000
<i>Sound Velocity</i>	Surface Sound Speed	AML Smart SV & T Probe
	Sound Velocity Profile	AML Smart SV & T Probe
<i>Water Levels</i>	---	NOAA Water Level Station #8423898 (Fort Point, NH)

B.1.3. *Echo sounding equipment*

The Simrad EM 3002 dual head multibeam echosounder was installed on the bow-mounted ram on the survey vessel for bathymetric data acquisition. Refer to Table 7 for system specifications. According to the manufacturer, the system allows for 100% along-track coverage at speeds of up

to 10kn with the water depths encountered on this survey. Thus the chosen survey speeds of around 7kn should not have presented problems regarding along-track coverage.

Table 7 - EM 3002D specifications (sourced from EM 3002 spec. sheet, Kongsberg, Inc).

<i>EM3002D</i>	
Serial Numbers	390(port)/ 389(starboard)
Frequency	293/ 307 kHz
Soundings per ping	Max 508
Max Ping Rate	40 Hz
Max Angular Coverage	200 degrees
Pitch stabilization	Yes
Roll Stabilization	Yes
Heave Compensation	Yes
Pulse Length	150 μ m
Depth resolution	1 cm
Beam Spacing	Equidistant or Equiangular

On 2005-06-13 problems with the communication between processing unit and sonar heads were encountered. They were solved on 2005-06-15 after exchanging the processing unit.

B.1.4. *Position, heading and motion reference systems*

An Applanix POS MV 320 v.4 provided position and attitude for the vessel and a combined Applanix inertial motion unit (IMU) provided orientation data for correction on acquisition.

Table 8 - Specifications for the Applanix POS MV

<i>Applanix POS/MV 320 (accuracies in 1-sigma interval)</i>	
Roll, pitch accuracy	0.02°
Heave accuracy	5 cm or 5%, whichever is greater
Heading accuracy	0.02°
Position accuracy	0.5 m
Velocity accuracy	0.03 m/s horizontal
Height above waterline	0.47 m

The POS MV was connected to the Seafloor Information System (SIS) workstation with two serial communication connections which output NMEA position information to the Simrad system and a binary format data stream containing attitude information. Differential corrections for the POS MV kinematic GPS receivers were obtained by the C-Nav DGPS receiver connection through to the POS MV.

B.1.5. *Sound speed measurement systems*

The Applied Microsystems SVPlus velocimeter (Table 9) was used to obtain sound speed casts throughout survey operations.

Table 9 -- Specifications for the Applied Microsystems SVPlus

<i>Applied Microsystems Ltd. SVPlus Velocimeter</i>	
Sound velocity	Range 1400 to 1550 m/s, Accuracy ± 0.05 m/s, Resolution 0.015 m/s
Temperature	Range -2 °C to 32 °C, Accuracy ± 0.05 °C, Resolution 0.001 °C
Pressure	Range assorted to 5000 dbar, Accuracy $\pm 0.15\%$ FS, Resolution 0.005% FS

Sound speed profiles were taken irregularly about four times each day, depending on discrepancies between the sound speed profile used and the surface sound speed measured at the sonar heads. Instrument programming and data download was carried out with the SmartTalk software which was used to convert sound speed profile files to synchronize with the SIS software used for data acquisition. Of the two data series (downward and upward casts), the cast which resulted in a more constant cast velocity was used. In general the two series did not show significant differences.

B.1.6. *Data acquisition software*

- Seafloor Information Systems (SIS)

The acquisition for the multibeam data for this survey was carried out using the Seafloor Information System (SIS), which is a real time software application designed to be the user interface and real time data processing system for hydrographic instruments produced by Simrad/Kongsberg Maritime.

- Hypack Max

Hypack Max was used for survey planning as well as logging backup navigation data during the survey.

B.1.7. *Data processing software*

- CARIS HIPS and SIPS

All processing of multibeam data was carried out in CARIS HIPS and SIPS

B.2. Quality Control

B.2.1. *Crosslines*

5 crosslines totaling 5.25 nm were run perpendicular to main scheme survey lines during the survey. The ratio of the lineal miles of crosslines to lineal miles of main scheme lines amounted to 9.3% which exceeds the 4% indicated by the NOS HSSD Section 5.2.4.3 for complete bathymetric coverage requirements. Crossline analysis was performed by generating base surfaces of crossline only data and main scheme only data and comparing the two surfaces using the difference surface analysis tool in Caris HIPS at IHO Order 1a specifications. The surfaces were generated at the same resolution as the product surface with an attribute value bin size of 1 m. The computed statistics from the analysis are shown in Table 10.

Table 10 - CARIS HIPS surface difference analysis for crosslines and main scheme lines

Number of points of comparison	851,691
Mean difference	0.01 m
Standard deviation	0.13 m
Minimum difference	-3.24 m
Maximum difference	2.94 m

The computed mean difference of 1 cm with a standard deviation of 0.13 indicates consistency of the data throughout the survey.

B.2.2. *Uncertainty*

The CUBE surface uncertainty child layer was examined in Caris HIPS in order to verify that no areas exceeded the IHO levels as described in the HSSD Section 5.1.3 for Order 1a survey specifications. The uncertainty levels for this survey all fell within the range required; however, slightly elevated levels are present on the edges of the survey limits where the outer beams are represented.

B.2.3. *Junctions*

No previous surveys were conducted prior to the 2005 survey detailed in this report. However, subsequent surveys have been completed in the period between the acquisition and the final compilation of the survey data in 2012. The subsequent surveys, planned and executed by CCOM/JHC in 2009 and 2010, were compiled with the objective of providing junctions with multibeam sonar data acquired in this survey and LIDAR data acquired by Fugro Pelagos () in order to provide comprehensive coverage of the Isle of Shoals for the purposes of updating nautical charts of the area.

Table 11 - Multibeam and Lidar surveys of the area which junction with the 2005 multibeam survey

<i>Survey</i>	<i>Registry #</i>	<i>Date</i>	<i>Sounder</i>	<i>Location</i>
Summer Hydro 2009 at UNH	W00206	June 2009	EM3002D	Isle of Shoals (south)
Summer Hydro 2010 at UNH		June 2010	EM3002D	Isle of Shoals (north)
Fugro Pelagos	H11296	Sep- Dec 2005	LiDAR	Isle of Shoals (shoal investigations)

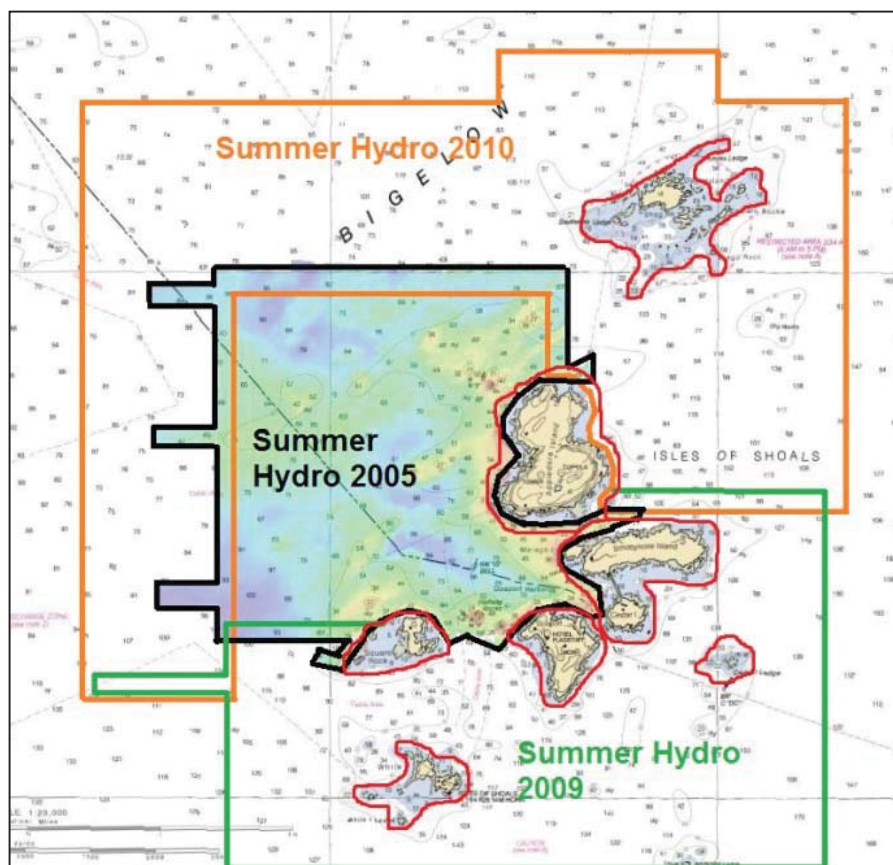

Figure 5 – Survey junctions. The 2010 survey limits are shown in orange, the 2009 survey limits are shown in green and the red inshore survey areas are the 2005 LiDAR survey

2009 Hydrographic Field Course Junction

The 2009 field course survey was conducted with the same vessel and sonar system as the 2005 survey.

The data and descriptive report from the 2009 hydrographic field course were submitted to NOAA and accepted on June 3rd 2010. The 1-meter cube surfaces from each survey were compared using IVS Fledermaus which resulted in an average depth difference of 0.16 m deeper for the 2009 survey. The submitted Descriptive Report for 2009 recommends that although the differences are within the allowable error tolerance for the survey that the 2009 data should be favored for updates of nautical charts where coverage areas overlap.

2010 Hydrographic Field Course Junction

The data from the 2010 hydrographic field course were acquired with the same vessel and sonar system as this survey. The data have not yet been submitted to NOAA for chart corrections. The processed 1-meter resolution CUBE surface from 2005 was compared with that from 2010 using IVS Fledermaus and mean surface difference of 0.23m deeper for the 2010 survey was determined. Further analysis has shown this difference to be constant. This difference is attributed to the discrepancies in settlement and squat offsets between the two surveys.

2005 Fugro Pelagos LiDAR survey

The junctions with data from the 2005 LiDAR survey have not been compared with the data from this survey.

B.2.4. Data Density

Data density for this survey was verified by exporting the density layer of the final CUBE surface as an ASCII file into Microsoft Excel and the results filtered to ascertain the number of nodes with at least 5 soundings. The results showed that 99.9% of nodes exceed the minimum density requirements for this survey.

Figure 6 illustrates the density distribution of soundings from 0-200 per node. Sounding density is lowest at the edges of the survey area, however they still exceed NOS survey specifications and the surveyed depths correlate well with the charted depths in these areas. Subsequent surveys have junctioned with the 2005 survey limits which have provided additional data for the areas where data density is lowest. Survey junctions are further discussed in section B.2.3 *Junctions*.

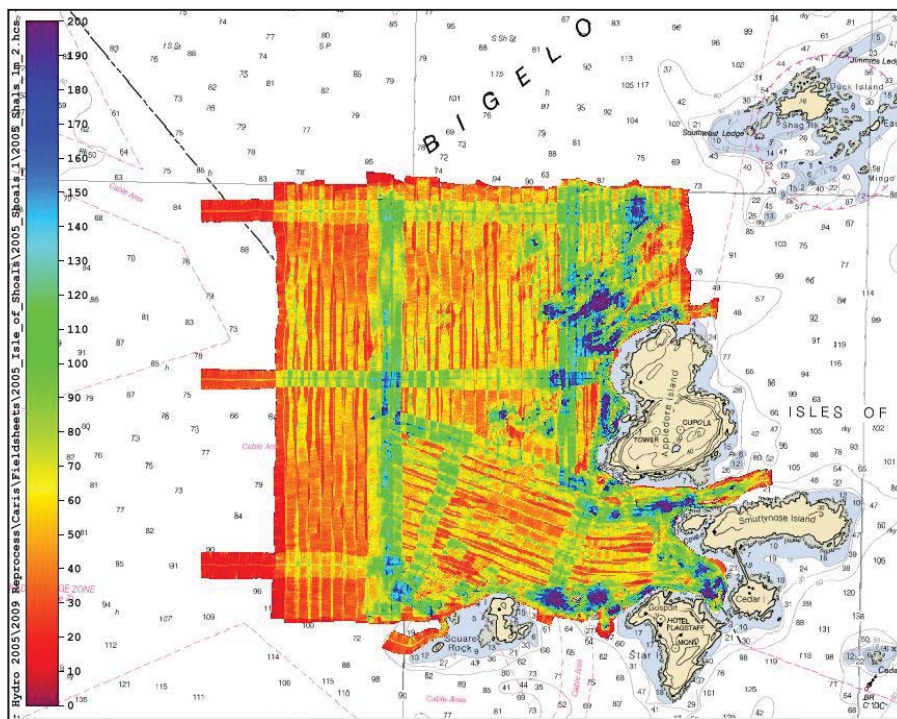

Figure 6 - Sounding data density as computed in CARIS HIPS

B.3. Corrections to echosoundings

B.3.1. *Vessel offsets*

Vessel offsets were measured prior to the survey with reference to the IMU and the angular offsets determined from the patch test described in Section 3.4.1. All offsets were entered into SIS and corrected for on acquisition. Refer to Appendix II (*Vessel description and offsets*) for details of offset measurements.

B.3.2. *Patch test*

A complete patch test according to Simrad specifications was carried out on 2005-06-03. It included time, pitch, roll and heading tests and resulted in the following adjustments to the head angles in SIS for the beam forming:

Table 12 - Corrections after patch test

Time	0.00
Pitch both heads	0°
Roll starboard head	+38.4°
Roll port head	-41.9°
Heading	0°
IMU Roll	0°
IMU Pitch	2°
IMU Heading	0.08°

B.3.3. *Static draft*

A static draft correction of 0.47 m was measured at the beginning of the survey and entered into SIS for correction upon acquisition. No further static draft measurements were made during the survey.

B.3.4. *Dynamic draft*

Dynamic draft corrections for the Coastal Surveyor were entered into the vessel configuration file in CARIS during reprocessing in 2009 with values obtained from a previous RTK experiment for determining the draft characteristics of the vessel. The full experiment report is included in the separates (*Separates IV Squat and Settlement Measurements for the R/V Coastal Surveyor*). The dynamic draft corrections that were entered into Caris are found in Table 13. Positive dynamic draft indicates that the vessel is lower in the water than at rest. Typical survey speeds were approximately 3m/s (6 knots) corresponding to a dynamic draft correction is less than 2 cm.

Table 13 - Dynamic draft corrections

Speed (m/s)	Dynamic Draft (m)
0.000	0.000
0.514	-0.025
1.029	-0.040
1.543	-0.043
2.058	-0.035
2.572	-0.017
3.087	0.012
3.601	0.053
4.114	0.104
4.603	0.166
5.144	0.239

B.3.5. *Heave, pitch and roll correctors*

Heave, pitch and roll were measured by the Applanix POS/MV 320 v.4, output to the sonar system and corrected for on acquisition. No additional heave corrections were applied in Caris.

B.3.6. *Sound speed corrections*

Sound speed corrections applied to soundings were determined using the profiles obtained from casts of the SVPlus velocimeter. Each resulting profile was entered on SIS, which in turn applied the corresponding sound speed corrections to the soundings. Digital files of each cast are included in the CARIS folder of submitted data.

C. VERTICAL AND HORIZONTAL CONTROL

C.1. Vertical control

Sounding data were tide adjusted with verified tide observations from station number 8423898, Fort Point, NH procured from the NOAA CO-OPS website. The parameters selected for the tidal data were: W1 time interval of 6 minutes, heights in meters, MLLW datum, for the period including June 1st to the 10th and June 20th to the 21st of 2005. The digital files are attached.

The tidal zoning for this survey was adjusted to Fort Point station applying a time corrector of -6 minutes and a range corrector of x1.00. These values were supplied by the Tide Service NOAA. The tide corrections were applied during post processing with Caris HIPS.

C.2. Horizontal control

The horizontal datum used for this survey was the World Geodetic System 1984 (WGS 84). Determination of both position and attitude of the RV Coastal Surveyor was achieved with the Applanix POS MV V4. The system is a combination of two kinematic GPS receivers and an inertial motion sensor.

Differential corrections for the GPS receivers were obtained by a C-Nav 2000 DGPS receiver from a satellite sending DGPS corrections specifically for hydrographic purposes.

D. RESULTS AND RECOMMENDATIONS

The 2005 CCOM/JHC Isle of Shoals survey as seen in Figure 7 meets the IHO Order 1a requirements and the NOS HSSD were followed as closely as possible. Chart comparisons of the survey area and the multibeam data acquired in this survey indicate significant discrepancies in the charted depths and the location of depth curves, particularly in the vicinity of the shoal areas close to the shore of the islands. It is recommended that the affected charts covering the Isle of Shoals are updated to reflect these differences.

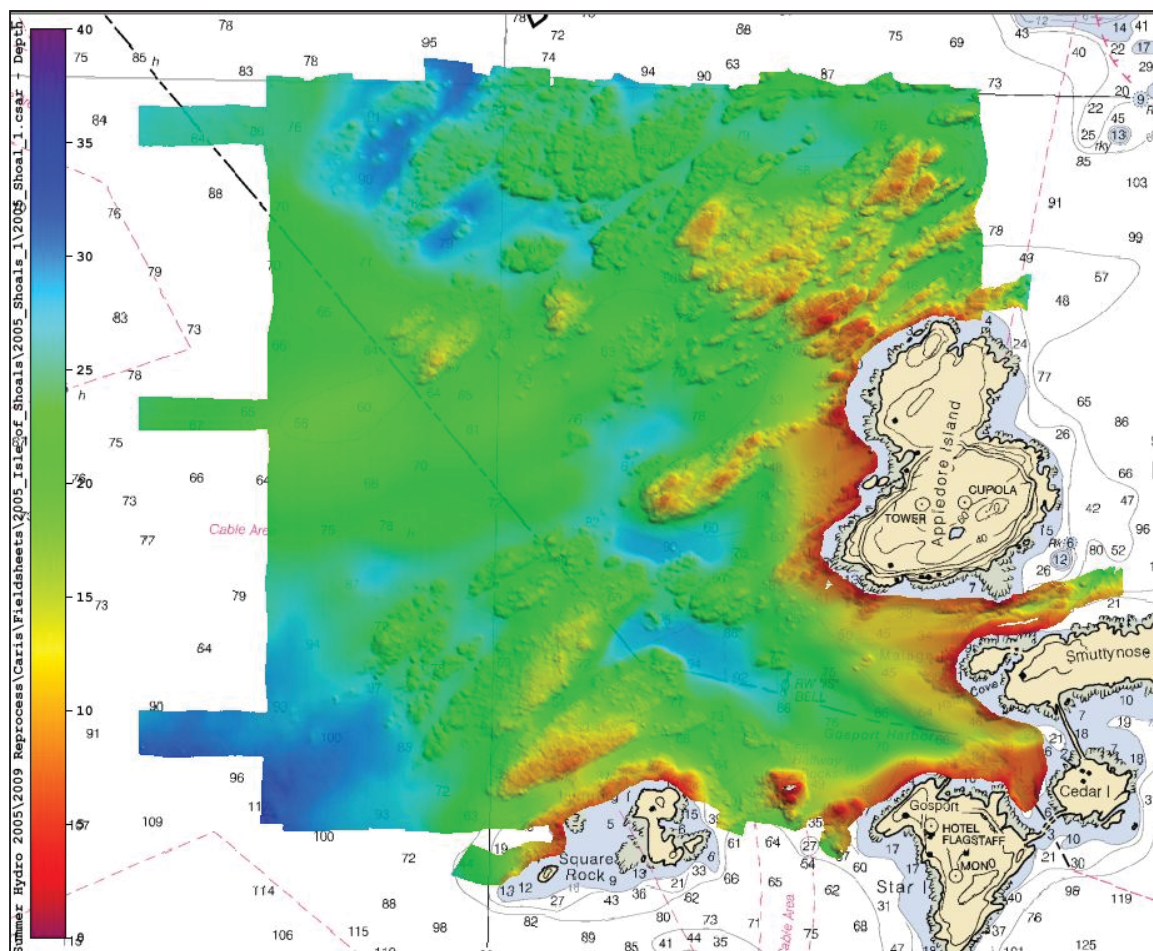

Figure 7 –Final 1 m CUBE surface of the 2005 Isle of Shoals survey (depths in meters)

D.1. Chart comparison

The final base surface for the survey area was overlain on raster chart 13283, 21st edition, March 2011, which, at a scale of 1:20,000, is the largest scale chart of the area for comparison purposes. Noted discrepancies are reported and illustrated graphically in the following section. Depths obtained from the multibeam sonar data (in NOAA feet for comparison to the chart) are shown in red and existing charted depth soundings and depth curves are shown in black.

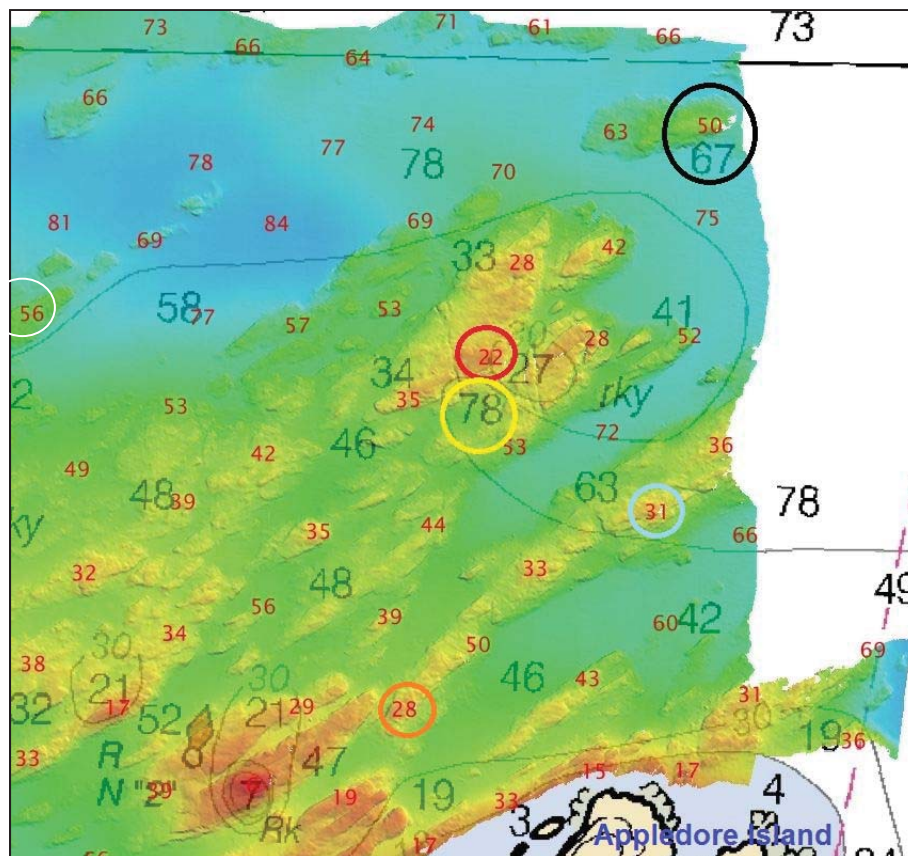

Figure 8 - Area to the north of Appledore Island indicating numerous erroneous soundings and misleading depth curves

Figure 8 shows the survey area to the north of Appledore Island. This graphic of the area clearly illustrates a discrepancy between the multibeam data and the charted 60 ft depth curve and numerous erroneous soundings which are detailed below.

The black circle indicates an unmarked 50 ft survey depth directly north of a 67 ft sounding.

The depth value in the red circle shows that the charted 27 ft sounding is shown as too deep and displaced to the south east.

The yellow circle indicates an erroneous 78 ft sounding where multibeam data showed a depth of 53 ft.

The gray circle shows a depth of 31 ft outside the current 60ft depth curve.

The orange circle indicates a 28 ft depth outside the 30 ft depth curve.

The white circle shows an erroneous 58 ft sounding where the survey depth was 77 ft. This sounding has affected the accurate charting of the 60 ft depth curve.

It is recommended that the depth curves north of Appledore Island should be redrafted to reflect the depths acquired in this survey and that erroneous soundings are updated to reflect the 2005 data

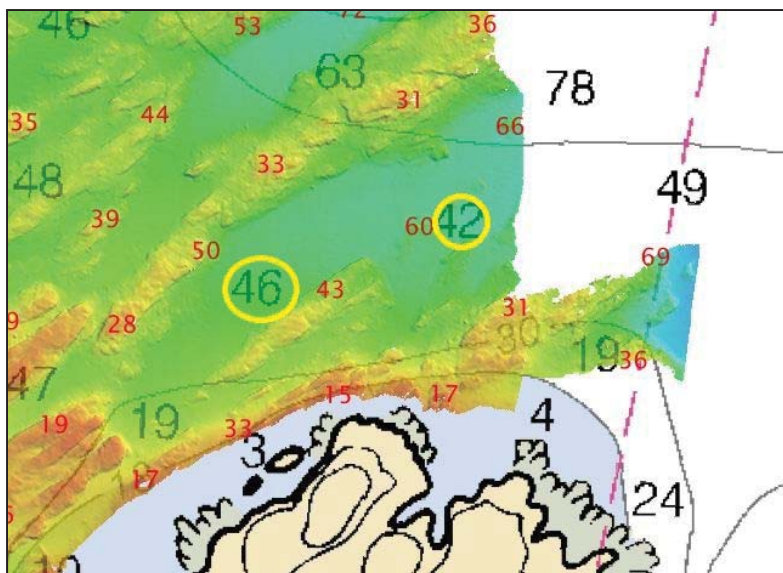

Figure 9 - Erroneous soundings north of Appledore Island

Figure 9 indicates two erroneous soundings where the multibeam bathymetry indicates a minimum depth of 60 ft.

It is recommended that the charted soundings should be updated to reflect the depths acquired in this survey.

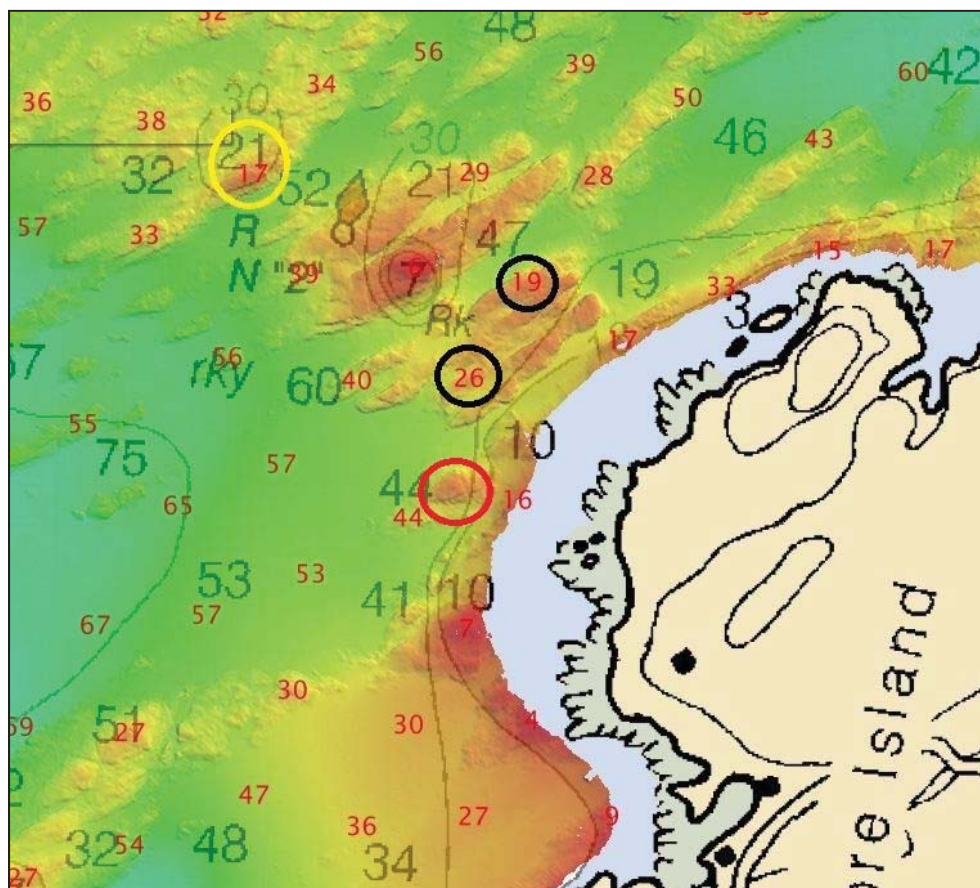

Figure 10 - Discrepancies in charted depth and depth curves to the northwest of Appledore Island

This survey found the shoal area to the east of the RN “2” navigation buoy to be significantly different than charted. This area is currently shown on charts as running in a north-south direction. However, the multibeam bathymetry shows that shoal runs in a northeast-southwest direction, as shown in Figure 6. The depth of the rock (charted at 7 ft) was surveyed at 6 ft. The shallower areas continue to the east and southeast of the charted rock as shown by the 19 ft and 26ft depths highlighted with a black circles in Figure 10. A reconfiguration of the depth curves in the area is recommended with an update to the charted depth of the rock.

The area highlighted by the red circle in Figure 10 indicates a 20 ft depth outside the existing 30ft depth curve. It is recommended that an update to the chart should include a re-drawing of the associated depth curve.

Further to the northwest, an area with a minimum depth of 17 ft (yellow circle) is currently charted as 21 ft and slightly displaced to the northwest. An update of the charted depth and position is recommended.

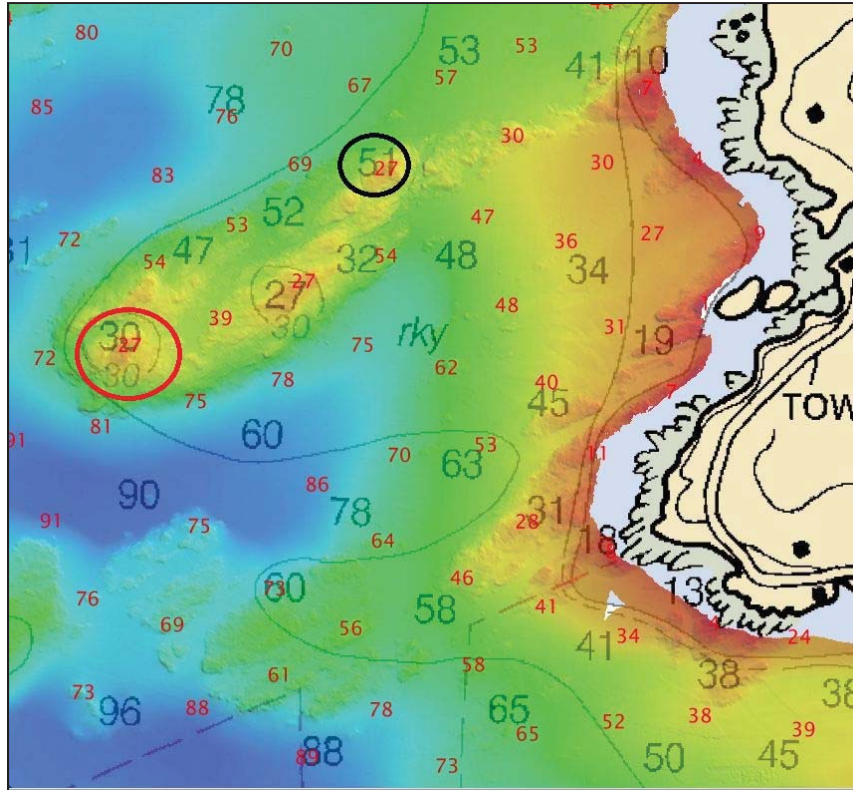

Figure 11 - Difference in charted soundings and multibeam depths to the west of Appledore Island. Also indicates a 60 ft depth curve discrepancy

The area shown in Figure 11 lies to the west of Appledore Island. The charted 60 ft depth curve is seen to be inconsistent with the depths acquired in this survey. Two depth discrepancies are shown, the first (black circle) shows a 27 ft depth superimposed directly onto a charted depth of 51 ft, the second (red circle) shows a survey depth of 27 ft on a 30 ft sounding. Updates are recommended to include an adjustment to the 60 ft depth curve and the shallower survey depths to replace the charted depths indicated above.

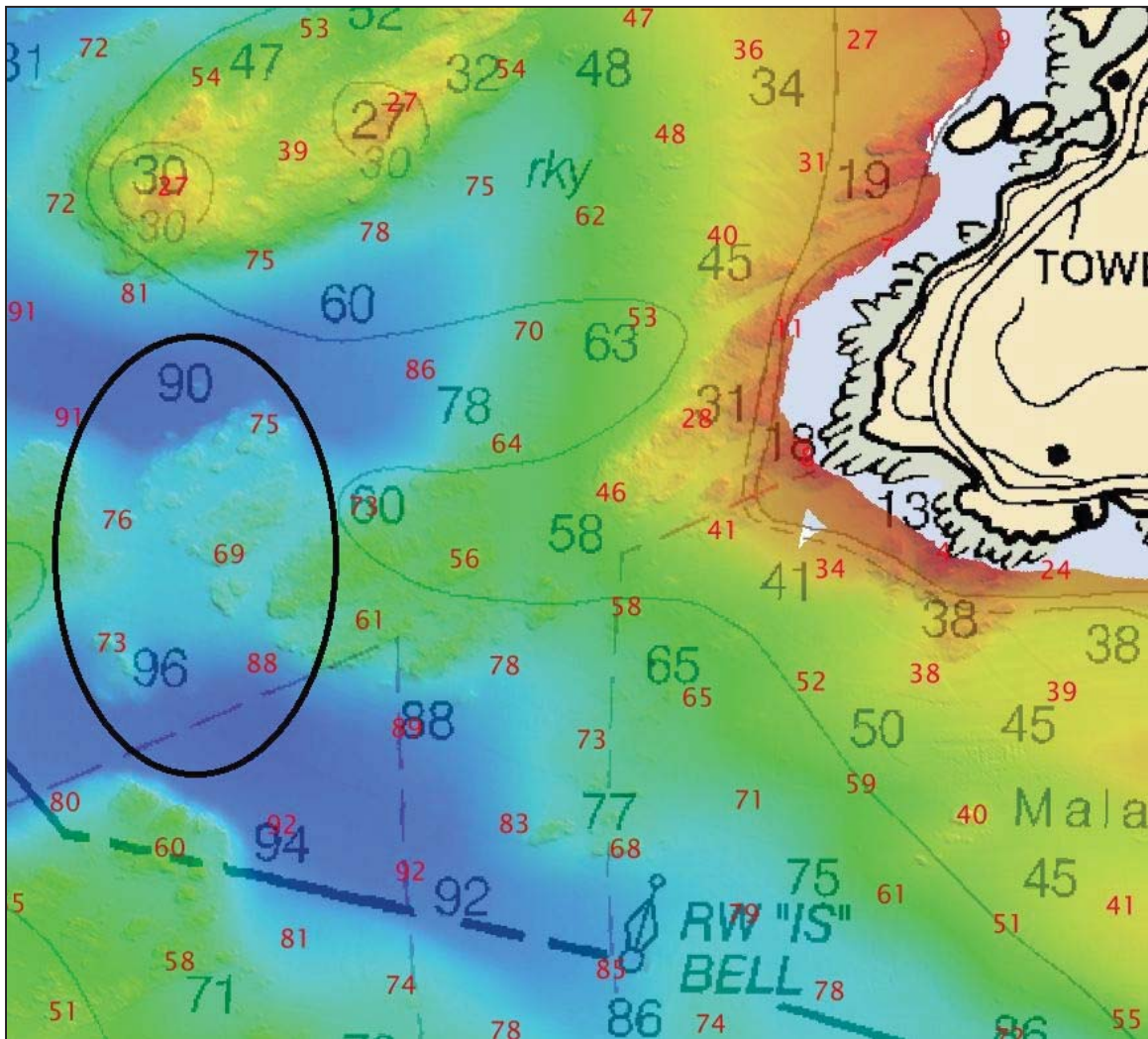

Figure 12 - Southwest of Appledore Island

Figure 12 highlights an area in between two soundings (90 ft and 96 ft) which show depths of between 69 and 75 feet. It is recommended charted depths are updated to reflect the shallower depths found in the survey area.

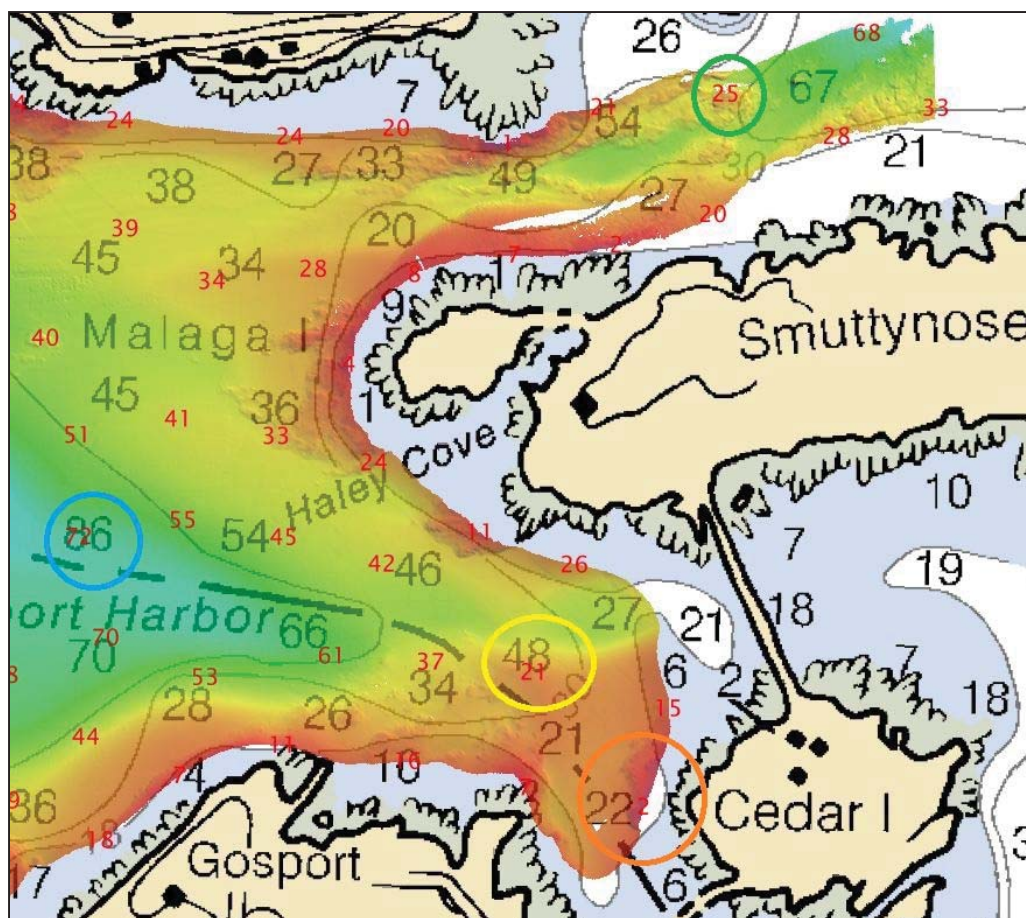

Figure 13 - Bathymetry to the north of Smuttynose Island and the approaches to Gosport Harbor

The depth highlighted by the green circle in Figure 13 indicates an uncharted 25 ft depth in the channel between Smuttynose and Appledore Islands. The 30 ft depth curves on either side of the channel and to the west of Smuttynose Island also show inconsistencies with survey depths (also see Fig. 17).

Further depth discrepancies are highlighted by the yellow and blue circles. The 21 ft depth shown in the yellow circle lies outside of the charted 30 ft depth curve and is directly adjacent to a 48 ft sounding.

The orange circle highlights an uncharted two ft extension of the ledge to the west of Cedar Island which lies outside of the existing 18 ft depth curve. Since this data were acquired at the survey limits, further investigation of the bathymetry of the region is recommended. However, since the shoal is delineated from its associated depth curve and the adjacent charted depth of 22 ft may be misleading, it is recommended that the chart is updated to include the survey depth for this shoal and a reconfiguration of the 18 ft depth curve.

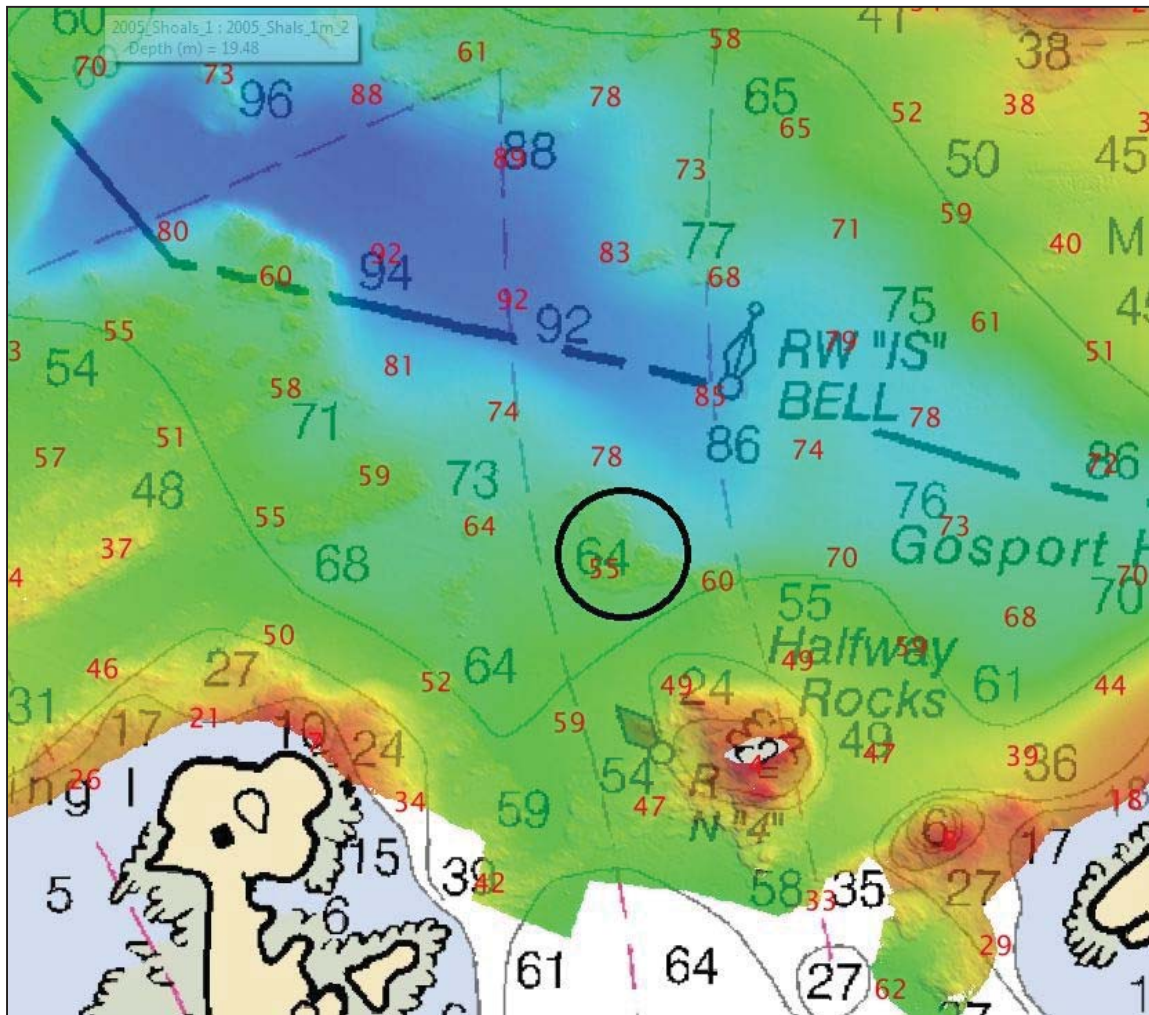

Figure 14 - Area to the northwest of Halfway Rocks

A survey depth of 55 ft to the northwest of Halfway Rocks is currently charted as 64 ft as shown by the highlighted area in Figure 14. An update of the charted depth is recommended.

The 60 ft depth curve for the region north of Square Rock is inconsistent with survey depths and should be updated to reflect the depths from the multibeam survey.

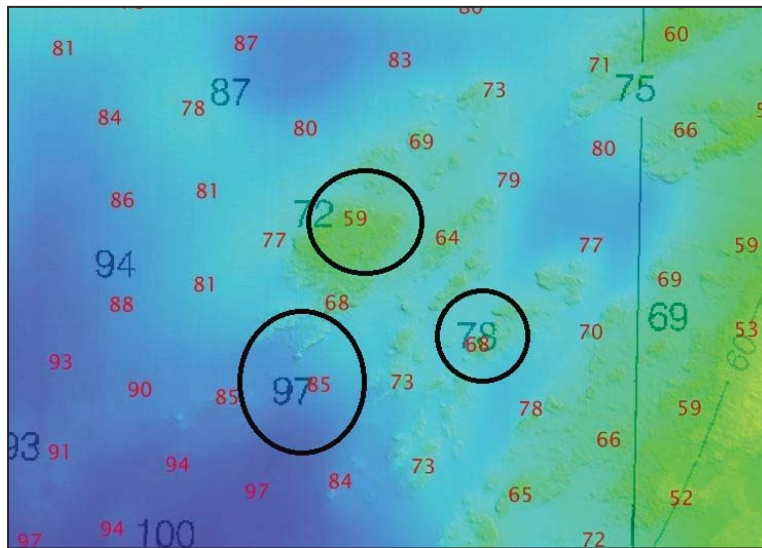

Figure 15 - Area surrounding position 42° 58' 58.43''N, 070° 38' 15.23''W

The depths highlighted in Figure 15 above show shallower depths than their corresponding charted soundings. The 59 ft survey depth is in position 42° 58' 58.43'' N 070° 38' 15.23'' W. Updates to the charted depths to more accurately depict the sea floor in this area are recommended.

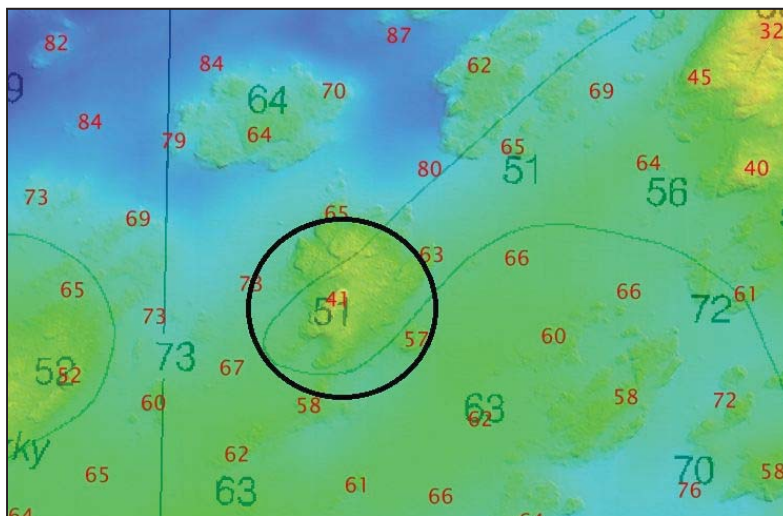

Figure 16 - Area surrounding position 42° 59' 34.28 N, 070° 37' 51.05''W

The black circle in Figure 16 indicates a survey depth of 41 ft at position 42° 59' 34.28'' N 070° 37' 51.05'' W where the charted depth sounding is 51 ft. An updated depth sounding at this position on the chart is recommended.

D.1.1. Comparison of depth curves

Table 14 - NOAA feet to meters conversion

Depth Curve	Feet		
	Created at: (ft)	Contour File	Lookup Table
		(m=*.75 ft)	(m=*.0 ft)
0	0.00	0.0000	-0.2286
18	18.75	5.7150	5.4864
30	30.75	9.3726	9.1440
60	60.75	18.5166	18.2880

Figure 17 illustrates a comparison of the existing depth curves and the contouring from the data obtained in this survey. Depth ranges are colored to correlate with the depth curves in NOAA feet converted to meters (see Table 14) on chart 13283. The color bar associated with the ranges is indicated in Table 15. Several inconsistencies were noted in the previous chart comparison section; however, the graphic below indicates that a significant percentage of the charted depth curves differ from the depths observed in this survey.

Table 15 - Color bar for surveyed depth ranges corresponding to charted depth curves

Color	0-5.715	5.716-9.372	9.373-18.51	18.517-36
Range (m)				

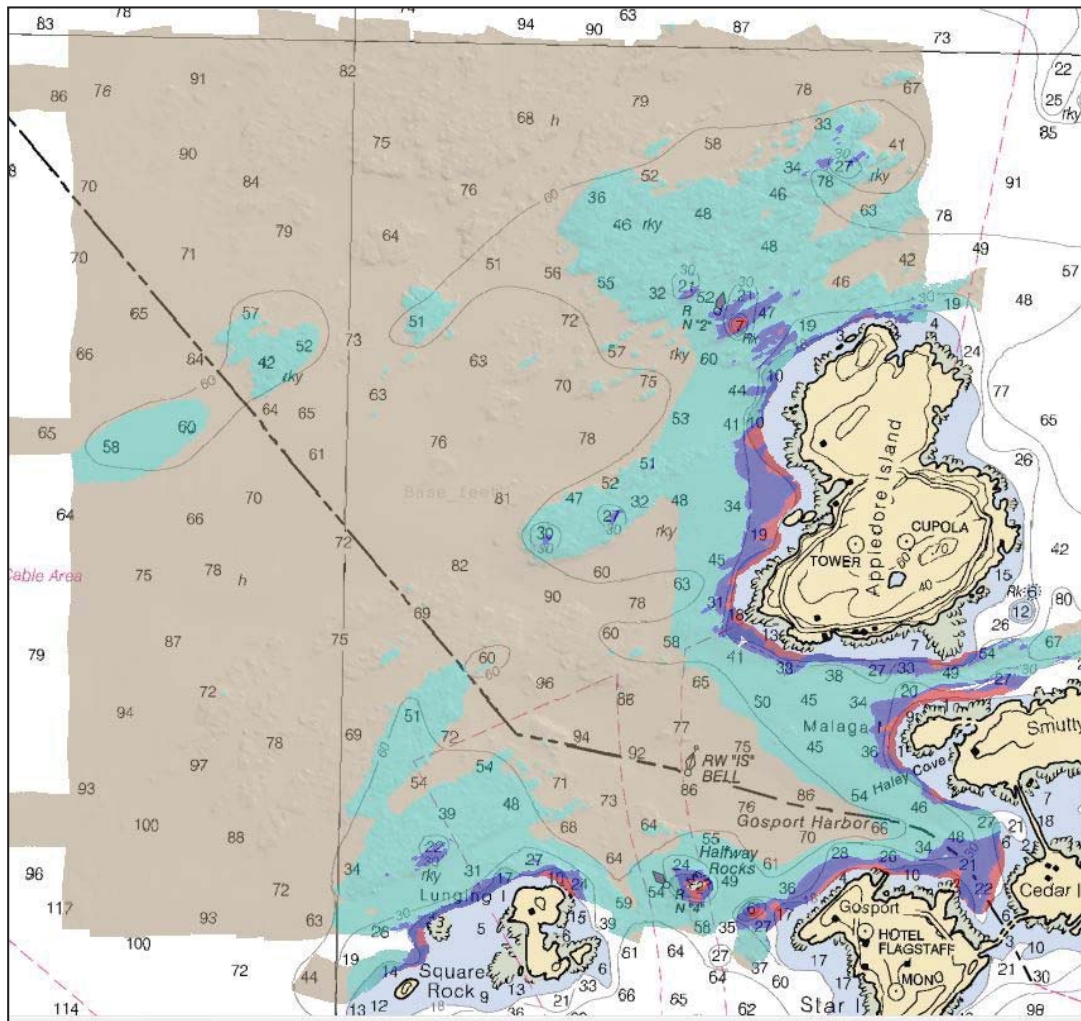

Figure 17 - Comparison of depth ranges generated from the multibeam data acquired in this survey and their corresponding charted depth curves from NOAA chart 13283

E. APPROVAL SHEET

Letter of Approval

State: New Hampshire

General Locality: Isle of Shoals

Sub Locality: Appledore and Smuttynose Islands

Year: 2005

Field Operations contributing to the accomplishment of this survey were conducted under my direct supervision with frequent checks of progress and adequacy. All surfaces and their reports were reviewed in their entirety.

This survey was completed with 100% multibeam coverage. It meets all applicable specifications and requirements and should supersede all prior surveys in common areas. The survey is considered complete and adequate for nautical charting.

CAPT. Andrew Armstrong, NOAA (ret.)
Director, Joint Hydrographic Center
Durham, NH

APPENDIX I

TIDE NOTE AND GRAPHICS
no Tide Note submitted with survey

APPENDIX II

SUPPLEMENTAL SURVEY RECORDS
AND CORRESPONDENCE

Appendix V – Processing Log

Processing Log
2005 Summer Hydro Survey, 2009 Reprocess

S. Greenaway, June 19, 2009, Processed data from 2005 is not available. This data was never submitted to NOAA and is the northern junction of the 2009 survey area.

I am reprocessing the data for junction comparison, quality evaluation, and potential submission to NOAA.

1. Created a new folder in \\Das01\Summer Hydro 2005\2009 Reprocess to hold all work.
2. Raw files from June 7, 2005 (DN158) appear to have been named with the incorrect date (eg 0001_20050608_003811_Coastal). The data is from DN158, it is likely that the clock on the SIS box was incorrect. This likely has no effect on data quality.
3. All of DN166 is inside Portsmouth Harbor.

APPENDIX III

SURVEY FEATURES REPORT

DTONs - Six

AWOIS - none

Wrecks - none

Maritime Boundaries - none

DTON Report

Registry Number: W00272

State: Maine/New Hampshire

Locality: Isle of Shoals

Sub-locality: Appledore Island/Gosport Harbour

Project Number: N/A

Survey Date: 06/07/2005 - 06/20/2005

Charts Affected

Number	Edition	Date	Scale (RNC)	RNC Correction(s)*
13283	20th	10/01/2007	1:20,000 (13283_1)	[L]NTM: ?
13274	27th	06/01/2007	1:40,000 (13274_2)	[L]NTM: ?
13278	26th	06/01/2005	1:80,000 (13278_1)	[L]NTM: ?
13260	40th	05/01/2007	1:378,838 (13260_1)	[L]NTM: ?
13009	33rd	05/01/2007	1:500,000 (13009_1)	[L]NTM: ?
13006	34th	05/01/2007	1:675,000 (13006_1)	[L]NTM: ?
13003	49th	04/01/2007	1:1,200,000 (13003_1)	[L]NTM: ?

* Correction(s) - source: last correction applied (last correction reviewed--"cleared date")

Features

No.	Name	Feature Type	Survey Depth	Survey Latitude	Survey Longitude	AWOIS Item
1.1	26 foot rocky depth	Shoal	8.14 m	42° 59' 13.9" N	070° 37' 33.8" W	---
1.2	27 foot rocky depth	Shoal	8.43 m	42° 59' 20.6" N	070° 37' 20.8" W	---
1.3	17 foot rocky depth	Shoal	5.31 m	42° 59' 37.0" N	070° 37' 16.5" W	---
1.4	22 foot rocky depth	Shoal	6.84 m	42° 59' 49.5" N	070° 36' 59.1" W	---
1.5	31 foot rocky depth	Shoal	9.57 m	42° 59' 44.1" N	070° 36' 51.0" W	---
1.6	50 foot rocky depth	Shoal	15.38 m	42° 59' 57.7" N	070° 36' 48.8" W	---

1.1) 26 foot rocky depth

DANGER TO NAVIGATION

Survey Summary

Survey Position: 42° 59' 13.9" N, 070° 37' 33.8" W
Least Depth: 8.14 m (= 26.72 ft = 4.454 fm = 4 fm 2.72 ft)
TPU ($\pm 1.96\sigma$): THU (TPEh) [None] ; TVU (TPEv) [None]
Timestamp: 2005-171.00:00:00.000 (06/20/2005)
Dataset: W00272_DTONs.000
FOID: 0_ 0000758859 00001(FFFE000B944B0001/1)
Charts Affected: 13283_1, 13274_2, 13278_1, 13260_1, 13009_1, 13006_1, 13003_1

Remarks:

[None]

Feature Correlation

Source	Feature	Range	Azimuth	Status
W00272_DTONs.000	0_ 0000758859 00001	0.00	000.0	Primary

Hydrographer Recommendations

[None]

Cartographically-Rounded Depth (Affected Charts):

26ft (13283_1, 13274_2, 13278_1)

4 ½fm (13260_1, 13009_1, 13006_1, 13003_1)

S-57 Data

Geo object 1: Sounding (SOUNDG)
Attributes: QUASOU - 6:least depth known
 SORDAT - 20050620
 SORIND - US,US,graph,W00272
 TECSOU - 3:found by multi-beam

Office Notes

COMPILATION: Depth in rocky seabed area. Chart as sounding

1.2) 27 foot rocky depth

DANGER TO NAVIGATION

Survey Summary

Survey Position: 42° 59' 20.6" N, 070° 37' 20.8" W
Least Depth: 8.43 m (= 27.66 ft = 4.610 fm = 4 fm 3.66 ft)
TPU ($\pm 1.96\sigma$): THU (TPEh) [None] ; TVU (TPEv) [None]
Timestamp: 2005-171.00:00:00.000 (06/20/2005)
Dataset: W00272_DTONs.000
FOID: 0_ 0000758857 00001(FFFE000B94490001/1)
Charts Affected: 13283_1, 13274_2, 13278_1, 13260_1, 13009_1, 13006_1, 13003_1

Remarks:

[None]

Feature Correlation

Source	Feature	Range	Azimuth	Status
W00272_DTONs.000	0_ 0000758857 00001	0.00	000.0	Primary

Hydrographer Recommendations

[None]

Cartographically-Rounded Depth (Affected Charts):

27ft (13283_1, 13274_2, 13278_1)

4 ½fm (13260_1, 13009_1, 13006_1, 13003_1)

S-57 Data

Geo object 1: Sounding (SOUNDG)
Attributes: QUASOU - 6:least depth known
 SORDAT - 20050620
 SORIND - US,US,graph,W00272
 TECSOU - 3:found by multi-beam

Office Notes

COMPILATION: Depth in rocky seabed area. Chart as sounding

1.3) 17 foot rocky depth

DANGER TO NAVIGATION

Survey Summary

Survey Position: 42° 59' 37.0" N, 070° 37' 16.5" W
Least Depth: 5.31 m (= 17.42 ft = 2.903 fm = 2 fm 5.42 ft)
TPU ($\pm 1.96\sigma$): **THU (TPEh)** [None] ; **TVU (TPEv)** [None]
Timestamp: 2005-171.00:00:00.000 (06/20/2005)
Dataset: W00272_DTONs.000
FOID: 0_ 0000758858 00001(FFFE000B944A0001/1)
Charts Affected: 13283_1, 13274_2, 13278_1, 13260_1, 13009_1, 13006_1, 13003_1

Remarks:

[None]

Feature Correlation

Source	Feature	Range	Azimuth	Status
W00272_DTONs.000	0_ 0000758858 00001	0.00	000.0	Primary

Hydrographer Recommendations

[None]

Cartographically-Rounded Depth (Affected Charts):

17ft (13283_1, 13274_2, 13278_1)

2 $\frac{3}{4}$ fm (13260_1, 13009_1, 13006_1, 13003_1)

S-57 Data

Geo object 1: Sounding (SOUNDG)
Attributes: QUASOU - 6:least depth known
 SORDAT - 20050620
 SORIND - US,US,graph,W00272
 TECSOU - 3:found by multi-beam

Office Notes

COMPILATION: Depth in rocky seabed area. Chart as sounding

1.4) 22 foot rocky depth

DANGER TO NAVIGATION

Survey Summary

Survey Position: 42° 59' 49.5" N, 070° 36' 59.1" W
Least Depth: 6.84 m (= 22.45 ft = 3.742 fm = 3 fm 4.45 ft)
TPU ($\pm 1.96\sigma$): **THU (TPEh)** [None] ; **TVU (TPEv)** [None]
Timestamp: 2005-171.00:00:00.000 (06/20/2005)
Dataset: W00272_DTONs.000
FOID: 0_ 0000758860 00001(FFFE000B944C0001/1)
Charts Affected: 13283_1, 13274_2, 13278_1, 13260_1, 13009_1, 13006_1, 13003_1

Remarks:

[None]

Feature Correlation

Source	Feature	Range	Azimuth	Status
W00272_DTONs.000	0_ 0000758860 00001	0.00	000.0	Primary

Hydrographer Recommendations

[None]

Cartographically-Rounded Depth (Affected Charts):

22ft (13283_1, 13274_2, 13278_1)

3 ¾fm (13260_1, 13009_1, 13006_1, 13003_1)

S-57 Data

Geo object 1: Sounding (SOUNDG)
Attributes: QUASOU - 6:least depth known
 SORDAT - 20050620
 SORIND - US,US,graph,W00272
 TECSOU - 3:found by multi-beam

Office Notes

COMPILATION: Depth in rocky seabed area. Chart as sounding

1.5) 31 foot rocky depth

DANGER TO NAVIGATION

Survey Summary

Survey Position: 42° 59' 44.1" N, 070° 36' 51.0" W
Least Depth: 9.57 m (= 31.41 ft = 5.235 fm = 5 fm 1.41 ft)
TPU ($\pm 1.96\sigma$): THU (TPEh) [None] ; TVU (TPEv) [None]
Timestamp: 2005-171.00:00:00.000 (06/20/2005)
Dataset: W00272_DTONs.000
FOID: 0_ 0000758856 00001(FFFE000B94480001/1)
Charts Affected: 13283_1, 13274_2, 13278_1, 13260_1, 13009_1, 13006_1, 13003_1

Remarks:

[None]

Feature Correlation

Source	Feature	Range	Azimuth	Status
W00272_DTONs.000	0_ 0000758856 00001	0.00	000.0	Primary

Hydrographer Recommendations

[None]

Cartographically-Rounded Depth (Affected Charts):

31ft (13283_1, 13274_2, 13278_1)

5 ¼fm (13260_1, 13009_1, 13006_1, 13003_1)

S-57 Data

Geo object 1: Sounding (SOUNDG)
Attributes: QUASOU - 6:least depth known
 SORDAT - 20050620
 SORIND - US,US,graph,W00272
 TECSOU - 3:found by multi-beam

Office Notes

COMPILATION: Depth in rocky seabed area. Chart as sounding

1.6) 50 foot rocky depth

DANGER TO NAVIGATION

Survey Summary

Survey Position: 42° 59' 57.7" N, 070° 36' 48.8" W
Least Depth: 15.38 m (= 50.46 ft = 8.409 fm = 8 fm 2.46 ft)
TPU ($\pm 1.96\sigma$): THU (TPEh) [None] ; TVU (TPEv) [None]
Timestamp: 2005-171.00:00:00.000 (06/20/2005)
Dataset: W00272_DTONs.000
FOID: 0_ 0000758855 00001(FFFE000B94470001/1)
Charts Affected: 13283_1, 13274_2, 13278_1, 13260_1, 13009_1, 13006_1, 13003_1

Remarks:

[None]

Feature Correlation

Source	Feature	Range	Azimuth	Status
W00272_DTONs.000	0_ 0000758855 00001	0.00	000.0	Primary

Hydrographer Recommendations

[None]

Cartographically-Rounded Depth (Affected Charts):

50ft (13283_1, 13274_2, 13278_1)

8 ¼fm (13260_1, 13009_1, 13006_1, 13003_1)

S-57 Data

Geo object 1: Sounding (SOUNDG)
Attributes: QUASOU - 6:least depth known
 SORDAT - 20050620
 SORIND - US,US,graph,W00272
 TECSOU - 3:found by multi-beam

Office Notes

COMPILATION: Depth in rocky seabed area. Chart as sounding

APPROVAL PAGE

W00272

Data meet or exceed current specifications as certified by the OCS survey acceptance review process. Descriptive Report and survey data except where noted are adequate to supersede prior surveys and nautical charts in the common area.

The following products will be sent to NGDC for archive

- W00272_DR.pdf
- Collection of depth varied resolution BAGS
- Processed survey data and records
- W00272_GeoImage.pdf

The survey evaluation and verification has been conducted according to current OCS Specifications, and the survey has been approved for dissemination and usage of updating NOAA's suite of nautical charts.

Approved: _____

Lieutenant Matthew Jaskoski, NOAA
Chief, Atlantic Hydrographic Branch